

# USER'S MANUAL

*notebook*





## Notice

The company reserves the right to revise this publication or to change its contents without notice. Information contained herein is for reference only and does not constitute a commitment on the part of the manufacturer or any subsequent vendor. They assume no responsibility or liability for any errors or inaccuracies that may appear in this publication nor are they in anyway responsible for any loss or damage resulting from the use (or misuse) of this publication.

This publication and any accompanying software may not, in whole or in part, be reproduced, translated, transmitted or reduced to any machine readable form without prior consent from the vendor, manufacturer or creators of this publication, except for copies kept by the user for backup purposes.

Brand and product names mentioned in this publication may or may not be copyrights and/or registered trademarks of their respective companies. They are mentioned for identification purposes only and are not intended as an endorsement of that product or its manufacturer.

©March 2014

## Trademarks

**Intel** and **Intel Core** are trademarks/registered trademarks of Intel Corporation.

## Preface

### R&TTE Directive

This device is in compliance with the essential requirements and other relevant provisions of the R&TTE Directive 1999/5/EC.

This device will be sold in the following EEA countries: Austria, Italy, Belgium, Liechtenstein, Denmark, Luxembourg, Finland, Netherlands, France, Norway, Germany, Portugal, Greece, Spain, Iceland, Sweden, Ireland, United Kingdom, Cyprus, Czech Republic, Estonia, Hungary, Latvia, Lithuania, Malta, Slovakia, Poland, Slovenia.

### ErP Off Mode Power Consumption Statement:

The figures below note the power consumption of this computer in compliance with European Commission (EC) regulations on power consumption in off mode

- Off Mode < 0.5W

## CE Marking

This device has been tested to and conforms to the regulatory requirements of the European Union and has attained CE Marking. The CE Mark is a conformity marking consisting of the letters “CE”. The CE Mark applies to products regulated by certain European health, safety and environmental protection legislation. The CE Mark is obligatory for products it applies to: the manufacturer affixes the marking in order to be allowed to sell his product in the European market.

This product conforms to the essential requirements of the R&TTE directive 1999/5/EC in order to attain CE Marking. A notified body has determined that this device has properly demonstrated that the requirements of the directive have been met and has issued a favorable certificate of expert opinion. As such the device will bear the notified body number 0560 after the CE mark.

The CE Marking is not a quality mark. Foremost, it refers to the safety rather than to the quality of a product. Secondly, CE Marking is mandatory for the product it applies to, whereas most quality markings are voluntary.

### **FCC Statement (Federal Communications Commission)**

You are cautioned that changes or modifications not expressly approved by the party responsible for compliance could void the user's authority to operate the equipment.

This equipment has been tested and found to comply with the limits for a Class B digital device, pursuant to Part 15 of the FCC Rules. These limits are designed to provide reasonable protection against harmful interference in a residential installation. This equipment generates, uses and can radiate radio frequency energy and, if not installed and used in accordance with the instructions, may cause harmful interference to radio communications. However, there is no guarantee that interference will not occur in a particular installation. If this equipment does cause harmful interference to radio or television reception, which can be determined by turning the equipment off and on, the user is encouraged to try to correct the interference by one or more of the following measures:

- Re orient or relocate the receiving antenna.
- Increase the separation between the equipment and receiver.
- Connect the equipment into an outlet on a circuit different from that to which the receiver is connected.
- Consult the service representative or an experienced radio/TV technician for help.

#### **Operation is subject to the following two conditions:**

1. This device may not cause interference.

And

2. This device must accept any interference, including interference that may cause undesired operation of the device.

## FCC RF Radiation Exposure Statement:

1. This Transmitter must not be co-located or operating in conjunction with any other antenna or transmitter.
2. This equipment complies with FCC RF radiation exposure limits set forth for an uncontrolled environment. This equipment should be installed and operated with a minimum distance of 20 centimeters between the radiator and your body.



### Warning

Use only shielded cables to connect I/O devices to this equipment. You are cautioned that changes or modifications not expressly approved by the manufacturer for compliance with the above standards could void your authority to operate the equipment.

### **IMPORTANT SAFETY INSTRUCTIONS**

Follow basic safety precautions, including those listed below, to reduce the risk of fire, electric shock, and injury to persons when using any electrical equipment:

1. Do not use this product near water, for example near a bath tub, wash bowl, kitchen sink or laundry tub, in a wet basement or near a swimming pool.
2. Avoid using this equipment with a telephone line (other than a cordless type) during an electrical storm. There may be a remote risk of electrical shock from lightning.
3. Do not use the telephone to report a gas leak in the vicinity of the leak.
4. Use only the power cord and batteries indicated in this manual. Do not dispose of batteries in a fire. They may explode. Check with local codes for possible special disposal instructions.
5. This product is intended to be supplied by a Listed Power Unit:
  - Full Range AC/DC Adapter - AC Input 100 - 240V, 50 - 60Hz, DC Output 19.5V, 6.15A (**120W**) minimum.

**This Computer's Optical Device is a Laser Class 1 Product**



## Instructions for Care and Operation

The notebook computer is quite rugged, but it can be damaged. To prevent this, follow these suggestions:

1. **Don't drop it, or expose it to shock.** If the computer falls, the case and the components could be damaged.





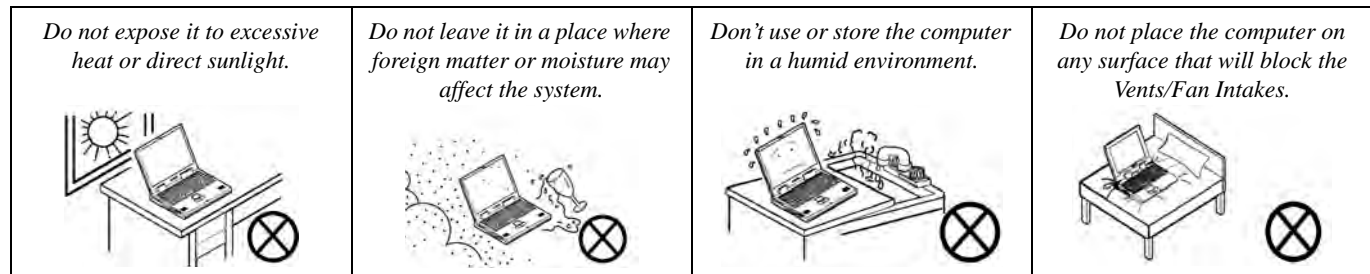

2. **Keep it dry, and don't overheat it.** Keep the computer and power supply away from any kind of heating element. This is an electrical appliance. If water or any other liquid gets into it, the computer could be badly damaged.



## Preface

- Avoid interference.** Keep the computer away from high capacity transformers, electric motors, and other strong magnetic fields. These can hinder proper performance and damage your data.
- Follow the proper working procedures for the computer.** Shut the computer down properly and don't forget to save your work. Remember to periodically save your data as data may be lost if the battery is depleted.

<p><i>Do not turn off the power until you properly shut down all programs.</i></p> 	<p><i>Do not turn off any peripheral devices when the computer is on.</i></p> 	<p><i>Do not disassemble the computer by yourself.</i></p> 	<p><i>Perform routine maintenance on your computer.</i></p> 
--	---	---	---

- Take care when using peripheral devices.**

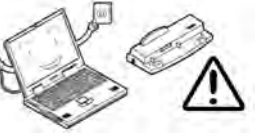
<p><i>Use only approved brands of peripherals.</i></p> 	<p><i>Unplug the power cord before attaching peripheral devices.</i></p> 
--	---

## Servicing

Do not attempt to service the computer yourself. Doing so may violate your warranty and may expose you and the computer to electric shock. Refer all servicing to authorized service personnel. Unplug the computer from the power supply. Then refer servicing to qualified service personnel under any of the following conditions:

- When the power cord or AC/DC adapter is damaged or frayed.
- If the computer has been exposed to rain or other liquids.
- If the computer does not work normally when you follow the operating instructions.
- If the computer has been dropped or damaged (do not touch the poisonous liquid if the LCD panel breaks).
- If there is an unusual odor, heat or smoke coming from your computer.



### Bottom Cover Removal Warning

Do not remove any cover(s) and /or screw(s) for the purposes of device upgrade as this may violate the terms of your warranty. If you need to replace/remove the hard disk/RAM/optical device etc., for any reason, please contact your distributor/supplier for further information.

### Removal Warning (For Service Personnel)

When removing any cover(s) and screw(s) for the purposes of device upgrade, remember to replace the cover(s) and screw(s) before restoring power to the system.

Also note the following when the cover is removed:

- Hazardous moving parts.
- Keep away from moving fan blades.

### Power Safety

The computer has specific power requirements:



#### Power Safety Warning (For Service Personnel)

Before you undertake any upgrade procedures, make sure that you have turned off the power, and disconnected all peripherals and cables (including telephone lines and power cord).

You must also remove your battery in order to prevent accidentally turning the machine on. **Before removing the battery disconnect the AC/DC adapter from the computer.**

- Only use a power adapter approved for use with this computer.
- Your AC/DC adapter may be designed for international travel but it still requires a steady, uninterrupted power supply. If you are unsure of your local power specifications, consult your service representative or local power company.
- The power adapter may have either a 2-prong or a 3-prong grounded plug. The third prong is an important safety feature; do not defeat its purpose. If you do not have access to a compatible outlet, have a qualified electrician install one.
- When you want to unplug the power cord, be sure to disconnect it by the plug head, not by its wire.
- Make sure the socket and any extension cord(s) you use can support the total current load of all the connected devices.
- Before cleaning the computer, make sure it is disconnected from any external power supplies (i.e. AC/DC adapter or car adapter).

*Do not plug in the power cord if you are wet.*



*Do not use the power cord if it is broken.*



*Do not place heavy objects on the power cord.*

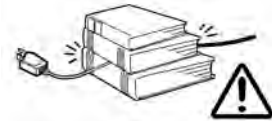

## Polymer Battery Precautions

Note the following information which is specific to polymer batteries only, and where applicable, this overrides the general battery precaution information overleaf.

- Polymer batteries may experience a slight expansion or swelling, however this is part of the battery's safety mechanism and is not a cause for concern.
- Use proper handling procedures when using polymer batteries. Do not use polymer batteries in high ambient temperature environments, and do not store unused batteries for extended periods.

See also the general battery precautionary information overleaf for further information.

### General Battery Precautions

- Only use batteries designed for this computer. The wrong battery type may explode, leak or damage the computer.
- Do not remove any batteries from the computer while it is powered on.
- Do not continue to use a battery that has been dropped, or that appears damaged (e.g. bent or twisted) in any way. Even if the computer continues to work with a damaged battery in place, it may cause circuit damage, which may possibly result in fire.
- If you do not use the battery for an extended period, then remove the battery from the computer for storage.
- Recharge the batteries using the notebook's system. Incorrect recharging may make the battery explode.
- Do not try to repair a battery pack. Refer any battery pack repair or replacement to your service representative or qualified service personnel.
- Keep children away from, and promptly dispose of a damaged battery. Always dispose of batteries carefully. Batteries may explode or leak if exposed to fire, or improperly handled or discarded.
- Keep the battery away from metal appliances.
- Affix tape to the battery contacts before disposing of the battery.
- Do not touch the battery contacts with your hands or metal objects.



#### Battery Disposal & Caution

The product that you have purchased contains a rechargeable battery. The battery is recyclable. At the end of its useful life, under various state and local laws, it may be illegal to dispose of this battery into the municipal waste stream. Check with your local solid waste officials for details in your area for recycling options or proper disposal.

Danger of explosion if battery is incorrectly replaced. Replace only with the same or equivalent type recommended by the manufacturer. Discard used battery according to the manufacturer's instructions.

## Cleaning

Do not apply cleaner directly to the computer; use a soft clean cloth.

Do not use volatile (petroleum distillates) or abrasive cleaners on any part of the computer.

## Travel Considerations

As you get ready for your trip, run through this list to make sure the system is ready to go:

1. Check that the battery pack and any spares are fully charged.
2. Power off the computer and peripherals.
3. Close the display panel and make sure it's latched.
4. Disconnect the AC/DC adapter and cables. Stow them in the carrying bag.
5. The AC/DC adapter uses voltages from 100 to 240 volts so you won't need a second voltage adapter. However, check with your travel agent to see if you need any socket adapters.
6. Put the notebook in its carrying bag and secure it with the bag's straps.
7. If you're taking any peripherals (e.g. a printer, mouse or digital camera), pack them and those devices' adapters and/or cables.
8. Anticipate customs - Some jurisdictions may have import restrictions or require proof of ownership for both hardware and software. Make sure your "papers" are handy.



### Power Off Before Traveling

Make sure that your notebook is completely powered off before putting it into a travel bag (or any such container). Putting a notebook which is powered on in a travel bag may cause the Vents/Fan Intakes to be blocked. To prevent your computer from overheating make sure nothing blocks the Vent/Fan Intakes while the computer is in use.

## Preface

### On the Road

In addition to the general safety and maintenance suggestions in this preface, and Chapter 8: Troubleshooting, keep these points in mind:

**Hand-carry the notebook** - For security, don't let it out of your sight. In some areas, computer theft is very common. Don't check it with "normal" luggage. Baggage handlers may not be sufficiently careful. Avoid knocking the computer against hard objects.

**Beware of Electromagnetic fields** - Devices such as metal detectors & X-ray machines can damage the computer, hard disk, floppy disks, and other media. They may also destroy any stored data - Pass your computer and disks around the devices. Ask security officials to hand-inspect them (you may be asked to turn it on). **Note:** Some airports also scan luggage with these devices.

**Fly safely** - Most airlines have regulations about the use of computers and other electronic devices in flight. These restrictions are for your safety, follow them. If you stow the notebook in an overhead compartment, make sure it's secure. Contents may shift and/or fall out when the compartment is opened.

**Get power where you can** - If an electrical outlet is available, use the AC/DC adapter and keep your battery(ies) charged.

**Keep it dry** - If you move quickly from a cold to a warm location, water vapor can condense inside the computer. Wait a few minutes before turning it on so that any moisture can evaporate.



## Developing Good Work Habits

Developing good work habits is important if you need to work in front of the computer for long periods of time. Improper work habits can result in discomfort or serious injury from repetitive strain to your hands, wrists or other joints. The following are some tips to reduce the strain:

- Adjust the height of the chair and/or desk so that the keyboard is at or slightly below the level of your elbow. Keep your forearms, wrists, and hands in a relaxed position.
- Your knees should be slightly higher than your hips. Place your feet flat on the floor or on a footrest if necessary.
- Use a chair with a back and adjust it to support your lower back comfortably.
- Sit straight so that your knees, hips and elbows form approximately 90-degree angles when you are working.
- Take periodic breaks if you are using the computer for long periods of time.



### Remember to:

- Alter your posture frequently.
- Stretch and exercise your body several times a day.
- Take periodic breaks when you work at the computer for long periods of time. Frequent and short breaks are better than fewer and longer breaks.



### Lighting

Proper lighting and a comfortable viewing angle can reduce eye strain and shoulder and neck muscle fatigue.

- Position the display to avoid glare or reflections from overhead lighting or outside sources of light.
- Keep the display screen clean and set the brightness and contrast to levels that allow you to see the screen clearly.
- Position the display directly in front of you at a comfortable viewing distance.
- Adjust the display-viewing angle to find the best position.

### LCD Screen Care

To prevent **image persistence** on LCD monitors (caused by the continuous display of graphics on the screen for an extended period of time) take the following precautions:

- Set the *Windows* **Power Plans** to turn the screen off after a few minutes of screen idle time.
- Use a rotating, moving or blank screen saver (this prevents an image from being displayed too long).
- Rotate desktop background images every few days.
- Turn the monitor off when the system is not in use.

### LCD Electro-Plated Logos

Note that in computers featuring a raised LCD electro-plated logo, the logo is covered by a protective adhesive. Due to general wear and tear, this adhesive may deteriorate over time and the exposed logo may develop sharp edges. Be careful when handling the computer in this case, and avoid touching the raised LCD electro-plated logo. Avoid placing any other items in the carrying bag which may rub against the top of the computer during transport. If any such wear and tear develops contact your distributor/supplier.

## Contents

Notice .....	I
ErP Off Mode Power Consumption Statement: .....	II
FCC Statement .....	IV
FCC RF Radiation Exposure Statement: .....	V
Instructions for Care and Operation .....	VII
Servicing .....	IX
Power Safety .....	X
Polymer Battery Precautions .....	XI
General Battery Precautions .....	XII
Cleaning .....	XIII
Travel Considerations .....	XIII

## Quick Start Guide

Overview .....	1-1
Advanced Users .....	1-2
Beginners and Not-So-Advanced Users .....	1-2
Warning Boxes .....	1-2
Not Included .....	1-3
System Software .....	1-4
Model Differences .....	1-5
System Startup .....	1-6

## Preface

System Map: LCD Panel Open - Model A .....	1-7
System Map: LCD Panel Open - Model B .....	1-8
System Map: LCD Panel Open - Model C .....	1-9
LED Indicators .....	1-10
Hot Key Buttons (Model B) .....	1-12
Keyboard .....	1-13
Illuminated Keyboard - Model C .....	1-14
Keyboard Shortcuts .....	1-15
Function Keys & Visual Indicators .....	1-16
Control Center .....	1-17
System Map: Front & Left Views .....	1-18
System Map: Right & Rear Views .....	1-19
System Map: Bottom View - Models A & C .....	1-20
System Map: Bottom View - Model B .....	1-21
Windows 8.1 Control Panel .....	1-22
Windows 8.1 Start Screen & Desktop .....	1-24
Apps & Tiles .....	1-25
Desktop Application .....	1-26
The Charms Bar .....	1-27
Windows 8.1 Control Panel .....	1-29
Windows 8.1 Taskbar .....	1-32
Video Features .....	1-33

Microsoft Hybrid Graphics .....1-33  
 Power Options .....1-37  
 Running Apps .....1-38

**Storage Devices, Audio & Mouse**

Overview .....2-1  
 Hard Disk Drive .....2-2  
 Optical Device .....2-3  
 Loading Discs .....2-3  
 Handling CDs or DVDs .....2-4  
 DVD Regional Codes .....2-5  
 Multi-in-1 Card Reader .....2-6  
 Audio Features .....2-7  
 Touchpad and Buttons/Mouse .....2-9  
 Gestures and Device Settings .....2-10

**Power Management**

Overview .....3-1  
 The Power Sources .....3-2  
 AC/DC Adapter .....3-2  
 Battery .....3-2  
 Turning On the Computer .....3-3  
 Shutting the Computer Down .....3-4

## Preface

Power Plans .....	3-5
Power-Saving States .....	3-7
Sleep .....	3-7
Hibernate .....	3-8
Shut down .....	3-8
Configuring the Power Buttons .....	3-9
Resuming Operation .....	3-11
Power Conservation Modes .....	3-12
Battery Information .....	3-14
Battery Power .....	3-14
Removing the Battery .....	3-15
Conserving Battery Power .....	3-16
Battery Life .....	3-17
New Battery .....	3-17
Recharging the Battery with the AC/DC Adapter .....	3-17
Proper handling of the Battery Pack .....	3-18
Battery FAQ .....	3-19

## Drivers & Utilities

What to Install .....	4-1
Module Driver Installation .....	4-1
Driver Installation .....	4-2

Updating/Reinstalling Individual Drivers .....	4-4
User Account Control .....	4-5
Windows Security Message .....	4-5
New Hardware Found .....	4-5
Driver Installation Procedure .....	4-6
Chipset .....	4-6
Video (VGA) .....	4-6
NVIDIA Video (VGA) .....	4-6
LAN .....	4-6
Card Reader .....	4-6
Touchpad .....	4-6
Hot Key .....	4-7
Airplane .....	4-7
MEI Driver .....	4-7
Audio .....	4-7
Optional Drivers .....	4-9

## **BIOS Utilities**

Overview .....	5-1
The Power-On Self Test (POST) .....	5-2
Failing the POST .....	5-3
Fatal Errors .....	5-3

## Preface

Non-Fatal Errors .....	5-3
The Setup Utility .....	5-4
Entering Setup .....	5-4
Setup Screens .....	5-5
Main Menu .....	5-6
System Time & Date (Main Menu) .....	5-6
SATA Port # (Main Menu) .....	5-7
System/Extended Memory (Main Menu) .....	5-7
MB Series / BIOS Revision / KBC/EC Firmware Revision (Main Menu) .....	5-7
Advanced Menu .....	5-8
Advanced Chipset Control (Advanced Menu) .....	5-8
mSATA/3G Slot Support (Advanced Menu > Advanced Chipset Control) .....	5-9
Intel(R) Rapid Start Technology (Advanced Menu) .....	5-10
SATA Mode (Advanced Menu) .....	5-10
Boot Logo (Advanced Menu) .....	5-10
Power On Boot Beep (Advanced Menu) .....	5-11
Battery Low Alarm Beep (Advanced Menu) .....	5-11
Security Menu .....	5-12
Set Supervisor Password (Security Menu) .....	5-12
Password on boot: (Security Menu) .....	5-13
Secure Boot (Security Menu) .....	5-13



Boot Menu .....5-14

Boot Option Priorities (Boot Menu) .....5-15

UEFI Boot (Boot Menu > OS Select) .....5-15

Exit Menu .....5-16

**Modules**

Overview .....6-1

Setting Up SATA RAID or AHCI Mode .....6-2

AHCI Mode .....6-2

RAID .....6-2

Intel® Rapid Storage Technology Application .....6-2

SATA RAID Setup Procedure (Windows 8.1) .....6-4

IRST Driver Installation .....6-10

Deleting a RAID (Windows 8.1) .....6-11

PC Camera Module .....6-12

PC Camera Audio Setup .....6-13

Camera App .....6-14

Camera Options .....6-15

Taking Pictures/Capturing Video .....6-16

Camera Roll .....6-17

Wireless LAN Module .....6-21

3rd Party 802.11b/g/n Driver Installation .....6-22

## Preface

Intel® WLAN Driver Installation .....	6-22
Qualcomm Atheros WLAN Combo Driver Installation .....	6-23
WLAN Configuration in Windows .....	6-24
Fingerprint Reader Module .....	6-27
AuthenTec Fingerprint Reader Driver Installation .....	6-28
BioExcess Fingerprint Reader Driver Installation .....	6-28
Fingerprint Module Configuration .....	6-29
Trusted Platform Module .....	6-31
Enabling & Activating TPM .....	6-32
Trusted Platform Module (TPM) Driver Installation .....	6-34
Initializing TPM .....	6-35
Infineon Security Platform Settings Tool .....	6-37
Bluetooth & WLAN Combo Module .....	6-45
3rd Party Bluetooth (V4.0) Combo Driver Installation .....	6-46
Intel Bluetooth Combo Driver Installation .....	6-46
Bluetooth Configuration in Windows .....	6-47
Intel® Rapid Storage Technology .....	6-50
IRST Driver Installation .....	6-50
Intel® Rapid Storage Technology for RAID Systems .....	6-51
RAID Volume Data Verification and Repair .....	6-53
Replacing and Reverting Recovery and Master Volumes .....	6-53
Intel® Smart Response Technology .....	6-55

Enabling Intel Smart Response Technology .....	6-56
Intel® Rapid Start Technology Driver .....	6-59
Intel® Rapid Start Technology Configuration .....	6-60
Intel® Rapid Start Technology Driver Installation .....	6-66
Sound Blaster Cinema EQ .....	6-67
Sound Blaster Cinema EQ Installation .....	6-67
Sound Blaster Cinema Application .....	6-68
Sound Blaster Cinema Controls .....	6-70
Wireless Display .....	6-72
Wireless Display Configuration .....	6-73
3G Module .....	6-76
3G Configuration in Windows .....	6-78
EM820W 3G Module PIN Code & Power-Saving .....	6-81

## **Troubleshooting**

Overview .....	7-1
Basic Hints and Tips .....	7-2
Backup and General Maintenance .....	7-3
Viruses .....	7-4
Upgrading and Adding New Hardware/Software .....	7-5
Problems and Possible Solutions .....	7-7
EM820W 3G Module PIN Code & Power-Saving .....	7-16

## Preface

Resolving the “Insert a SIM” issue with the 3G Module (Windows 8.1) .....7-18

## Interface (Ports & Jacks)

Overview .....	A-1
Ports and Jacks .....	A-2
Card Reader .....	A-2
DC-In Jack .....	A-2
External Monitor (VGA) Port .....	A-2
e-SATA / USB 3.0 Combo Port .....	A-2
HDMI-Out Port .....	A-3
Headphone-Out Jack .....	A-3
Microphone-In Jack .....	A-3
RJ-45 LAN Jack .....	A-3
S/PDIF-Out Jack .....	A-3
Security Lock Slot .....	A-3
USB 2.0/1.1 Ports .....	A-4
USB 3.0 Port .....	A-4

## Control Center

Overview .....

B-1

## Video Driver Controls

Video Driver Installation .....

C-1

Video (VGA) ..... C-1

NVIDIA Video (VGA) ..... C-1

Microsoft Hybrid Graphics ..... C-2

Intel® Dynamic Video Memory Technology ..... C-4

Intel® HD Graphics Control Panel ..... C-5

Display Devices & Options ..... C-19

Attaching Other Displays ..... C-20

Attaching Other Displays - Devices (Charms Bar) ..... C-23

Configuring an External Display In Windows ..... C-24

NVIDIA Control Panel ..... C-26

Customization Options ..... C-28

Set PhysX® Configuration ..... C-32

HDMI Audio Configuration ..... C-33

**Specifications**

Processor ..... D-2

Core Logic ..... D-2

Display ..... D-2

Memory ..... D-3

Video Adapter Options ..... D-3

Storage ..... D-3

Audio ..... D-3

## Preface

Keyboard & Pointing Device .....	D-3
Interface .....	D-3
Card Reader .....	D-4
Slots .....	D-4
Communication .....	D-4
BIOS .....	D-4
Security .....	D-4
Operating System .....	D-4
Features .....	D-5
Indicators .....	D-5
Power .....	D-5
Power Management .....	D-5
Environmental Spec .....	D-5
Physical Dimensions & Weight .....	D-5

# Chapter 1: Quick Start Guide

## Overview

This Quick Start Guide is a brief introduction to the basic features of your computer, to navigating around the computer and to getting your system started. The remainder of the manual covers the following:

- **Chapter 2** A guide to using some of the main features of the computer e.g. the **storage devices (hard disk, optical device, card reader), TouchPad & Mouse & Audio Features.**
- **Chapter 3** The computer's **power** management options.
- **Chapter 4** The installation of the **drivers** and utilities essential to the operation or improvement of some of the computer's subsystems.
- **Chapter 5** An outline of the computer's built-in software or **BIOS** (Basic Input Output System).
- **Chapter 6** Instructions for **upgrading** your computer.
- **Chapter 7** A quick guide to the computer's **PC Camera, Wireless LAN, Fingerprint, Bluetooth & WLAN Combo, Intel technology, Sound Blaster Audio** and **3G** modules (some of which may be **optional** depending on your purchase configuration).
- **Chapter 8** A **troubleshooting** guide.
- **Appendix A** Definitions of the **interface, ports/jacks** which allow your computer to communicate with external devices.
- **Appendix B** Information on the **Control Center.**
- **Appendix C** Information on the **Video driver** controls.
- **Appendix D** The computer's **specification.**

## Advanced Users

If you are an advanced user you may skip over most of this Quick Start Guide. However you may find it useful to refer to *“Drivers & Utilities” on page 4 - 1*, *“BIOS Utilities” on page 5 - 1* and *“Upgrading The Computer” on page 6 - 1* in the User’s Manual. You may also find the notes marked with a  of interest to you.



### Notes

Check the light colored boxes with the mark above to find detailed information about the computer’s features.

## Beginners and Not-So-Advanced Users

If you are new to computers (or do not have an advanced knowledge of them) then the information contained in this Quick Start Guide should be enough to get you up and running. Eventually you should try to look through all the documentation (more detailed descriptions of the functions, setup and system controls are covered in the remainder of the User’s Manual), but do not worry if you do not understand everything the first time. Keep this manual nearby and refer to it to learn as you go. You may find it useful to refer to the notes marked with a  as indicated in the margin. For a more detailed description of any of the interface ports and jacks see *“Interface (Ports & Jacks)” on page A - 1*.

## Warning Boxes

No matter what your level please pay careful attention to the warning and safety information indicated by the  symbol. Also please note the safety and handling instructions as indicated in the *Preface*.



## Not Included

Operating Systems (e.g. *Windows 8.1*) and applications (e.g. word processing, spreadsheet and database programs) have their own manuals, so please consult the appropriate manuals.



### Drivers

If you are installing new system software, or are re-configuring your computer for a different system, you will need to install the appropriate drivers. Drivers are programs which act as an interface between the computer and a hardware component e.g. a wireless network module. It is very important that you install the drivers in the order listed in [Table 4 - 1, on page 4 - 3](#). You will be unable to use most advanced controls until the necessary drivers and utilities are properly installed. If your system hasn't been properly configured (your service representative may have already done that for you), refer to [“Drivers & Utilities” on page 4 - 1](#) for installation instructions.

### Ports and Jacks

See [“Ports and Jacks” on page A - 2](#) for a description of the interface (ports & jacks) which allow your computer to communicate with external devices, connect to the internet etc.

## System Software

Your computer may already come with system software pre-installed. Where this is not the case, or where you are re-configuring your computer for a different system, you will find the **Windows 8.1** operating system is supported.



### Windows OS

Note that the information included on the following pages is for **Windows 8.1 only**.

In order to run **Windows 8.1 (64 bit)** your computer requires a minimum **2GB** of system memory (RAM).

## Model Differences

This notebook series includes **three** different model types that mainly differ as indicated in the table below. Note that your model may appear slightly different from those pictured in this manual.

Feature	Model A	Model B	Model C
<b>Display Type Supported</b>	15.6" (39.62cm) FHD (1920 * 1080) 16:9 LCD Panel	17.3" (43.94cm) FHD (1920 * 1080) 16:9 LCD Panel	15.6" (39.62cm) FHD (1920 * 1080) 16:9 LCD Panel
<b>3G Module</b>	UMTS/HSPDA <b>OR</b> UMTS/HSPDA+ based <b>3G Module</b> with Mini-Card Interface ( <b>Factory Option</b> )	N/A	UMTS/HSPDA <b>OR</b> UMTS/HSPDA+ based <b>3G Module</b> with Mini-Card Interface ( <b>Factory Option</b> )
<b>Fingerprint Reader Module</b>	Supported	Not Supported	Supported
<b>Illuminated Keyboard</b>	Not Supported	Not Supported	Supported
<b>Dimensions &amp; Weight</b>	374mm (w) * 250mm (d) * 16.3 - 42.7mm (h) 2.7kg with ODD and Battery	413mm (w) * 277.5mm (d) * 17.5 - 44mm (h) 3.2kg with ODD and Battery	374mm (w) * 250mm (d) * 16.7 - 43.1mm (h) 2.7kg with ODD and Battery

*Table 1 - 1 - Model Differences*

## System Startup

1. Remove all packing materials, and place the computer on a stable surface.
2. Securely attach any peripherals you want to use with the notebook (e.g. keyboard and mouse) to their ports.
3. Make sure the battery is inserted and locked in position.
4. Attach the AC/DC adapter to the DC-In jack at the rear of the computer, then plug the AC power cord into an outlet, and connect the AC power cord to the AC/DC adapter (**make sure you use the adapter when first setting up the computer**, as to safeguard the computer during shipping the battery will be locked to not power the system until first connected to the AC/DC adapter).
5. Use one hand to raise the lid/LCD to a comfortable viewing angle (**do not exceed 130 degrees**); use the other hand to support the base of the computer (**Note: Never lift the computer by the lid/LCD**).
6. Press the power button on the top right of the computer **for about 2 - 3 seconds** to turn the computer “on”.

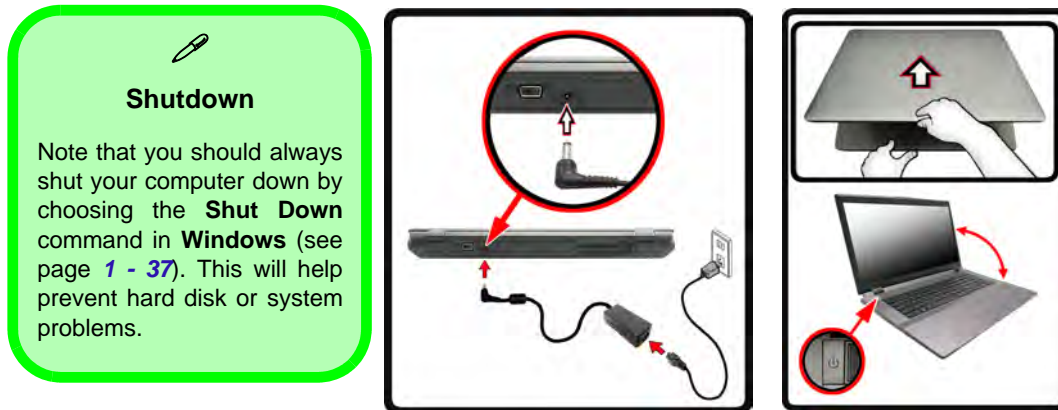

Figure 1 - 1 - Opening the Lid/LCD & Computer with AC/DC Adapter Plugged-In

## System Map: LCD Panel Open - Model A

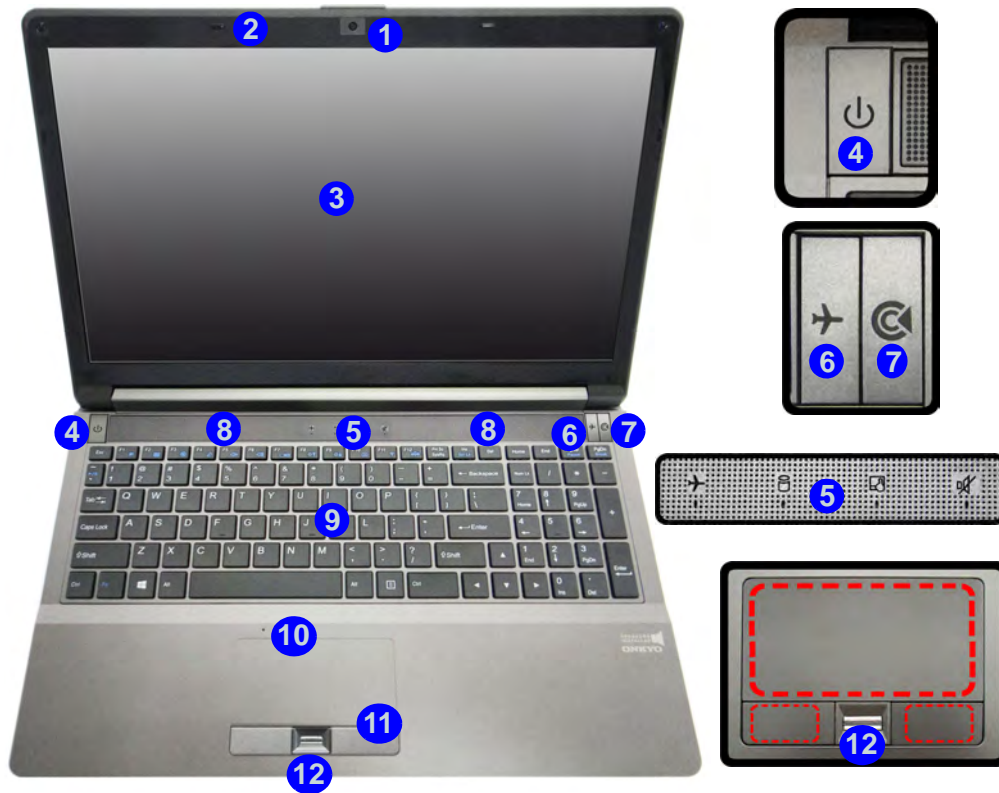

Figure 1 - 2  
LCD Panel Open - Model A

1. Built-In PC Camera
2. PC Camera LED
3. LCD
4. Power Button
5. Top Case LED Indicators
6. Airplane Mode Button
7. Control Center Launch Button
8. Speakers
9. Keyboard
10. Built-In Microphone
11. Touchpad & Buttons
12. Fingerprint Reader Sensor (**Factory Option**)

Note that the Touchpad and Buttons valid operational area is that indicated within the red dotted lines left.

## Quick Start Guide

Figure 1 - 3  
LCD Panel Open -  
Model B

1. Built-In PC Camera
2. PC Camera LED
3. LCD
4. Power Button
5. Control Center  
Launch Button
6. Speakers
7. Top Case LED  
Indicators
8. Hot Key Buttons
9. Keyboard
10. Built-In Microphone
11. Touchpad & Buttons

## System Map: LCD Panel Open - Model B

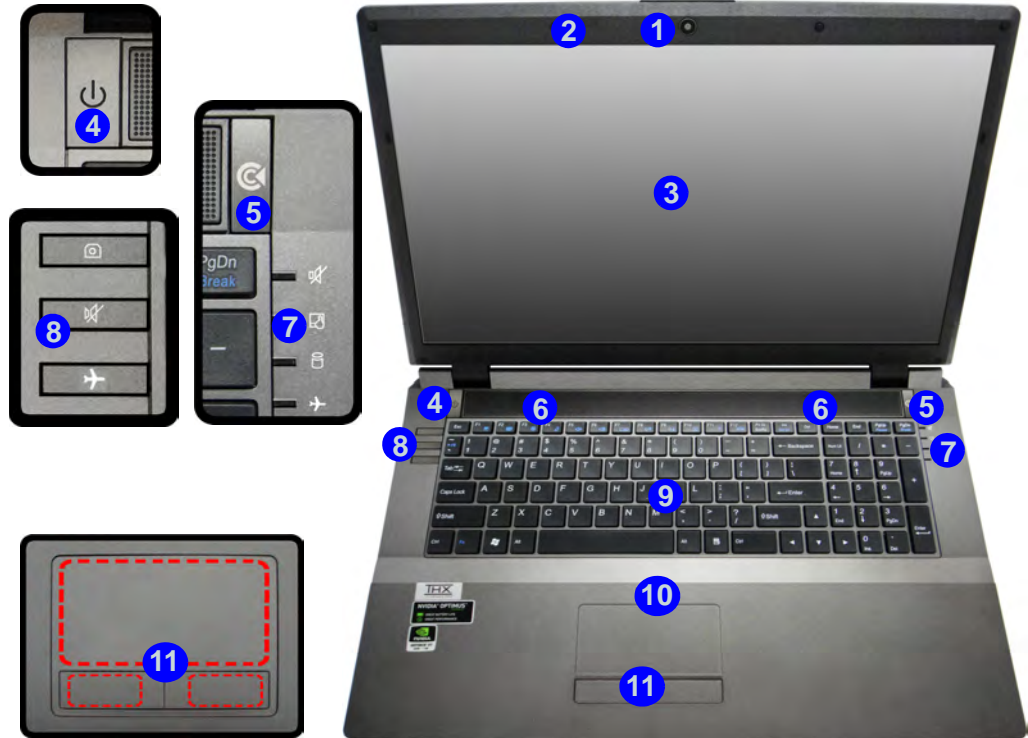

Note that the Touchpad and Buttons valid operational area is that indicated within the red dotted lines right.

## System Map: LCD Panel Open - Model C

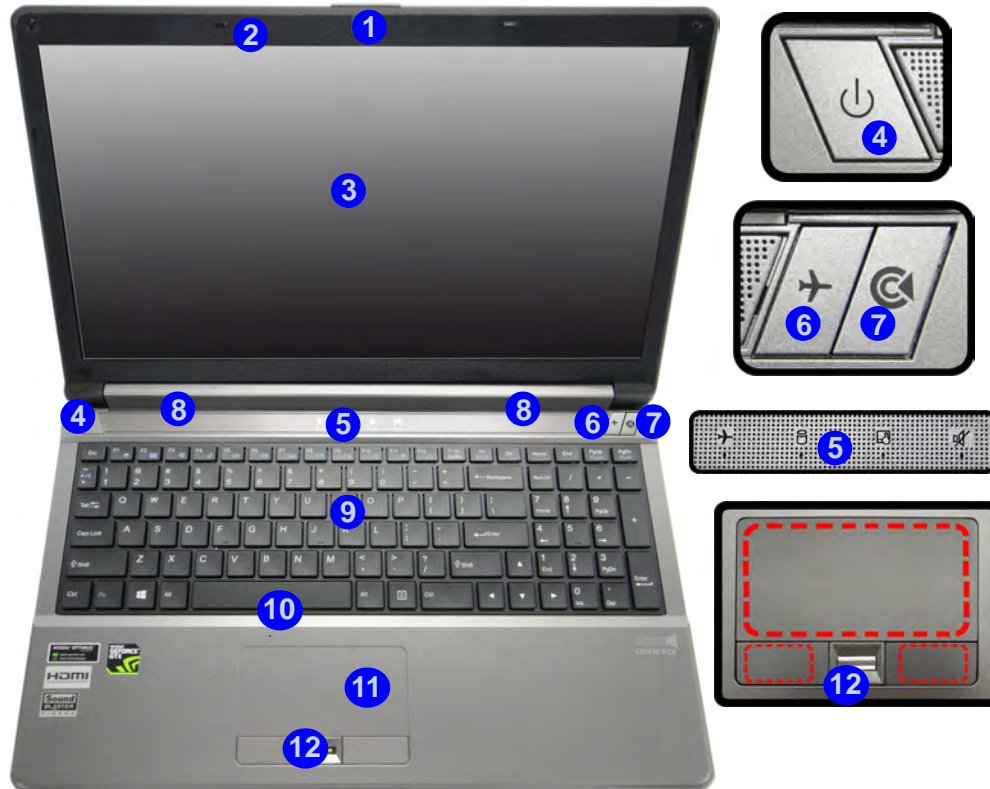





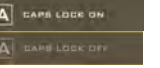

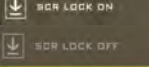

Figure 1 - 4  
LCD Panel Open - Model C

1. Built-In PC Camera
2. PC Camera LED
3. LCD
4. Power Button
5. Top Case LED Indicators
6. Airplane Mode Button
7. Control Center Launch Button
8. Speakers
9. Illuminated Keyboard
10. Built-In Microphone
11. Touchpad & Buttons
12. Fingerprint Reader Sensor (**Factory Option**)

Note that the Touchpad and Buttons valid operational area is that indicated within the red dotted lines left.

## LED Indicators

The LED indicators on the computer display helpful information about the current status of the computer.

Icon	Color	Description	Icon	Color	Description
	Orange	AC/DC Power is Plugged In		Green	Number Lock is Activated 
	Green	The Computer is On		Green	Caps Lock is Activated 
	Blinking Green	The Computer is in Sleep Mode		Green	Scroll Lock is Activated 
	Orange	The Battery is Charging			
	Green	The Battery is Fully Charged			
	Blinking Orange	The Battery Has Reached Critically Low Power Status			

*Table 1 - 2 - Front Left LED Indicators*

See overleaf for information on the Top Case LED indicators.







Icon	Color	Description
	White	Hard Disk/ODD Activity
	Green	<b>Airplane Mode is ON</b> (the WLAN, Bluetooth & 3G Modules are OFF)
	Green	The Computer is Powered On
	Orange	The Audio is Muted
	Green	The Touchpad is Powered Off

Table 1 - 3 - Top Case LED Indicators







### Wireless Device Operation Aboard Aircraft

The use of any portable electronic transmission devices aboard aircraft is usually prohibited. Make sure the **3G/WLAN/Bluetooth** module(s) are OFF if you are using the computer aboard aircraft. Use **Airplane Mode** hot key to toggle Airplane Mode On/Off, and check the LED indicator for the power status.

## Hot Key Buttons (Model B)

Press the hot key buttons on the computer to toggle the appropriate function on/off.

Icon	Description
	Control Center Launch Button
	Power On/Off the ( <b>optional</b> ) PC Camera
	Mute On/Off
	Turn On/Off Airplane Mode
	Power the Computer On/Off

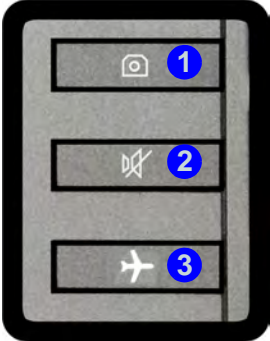
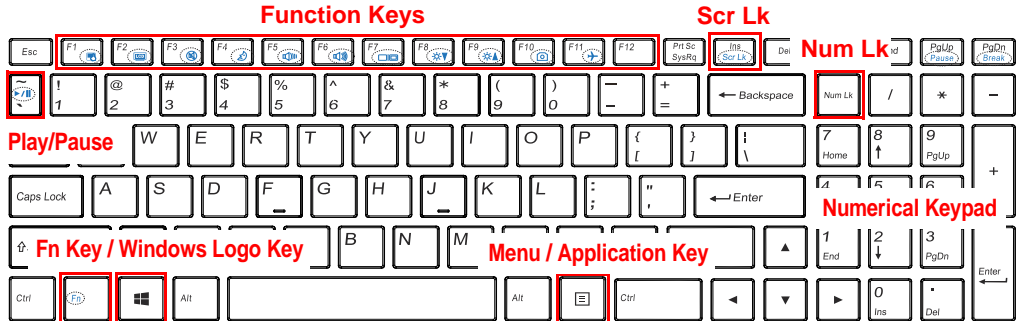



Table 1 - 4 - Hot Key Buttons

Note that **Models A** and **C** support only the Control Center Launch , Airplane Mode  & Power  hot key buttons (see *“System Map: LCD Panel Open - Model A” on page 1 - 7*).

# Keyboard

The keyboard has an embedded numerical keypad for easy numeric data input, and features function keys to allow you to change operational features instantly.





### Special Characters

Some software applications allow the number-keys to be used with Alt to produce special characters. These special characters can only be produced by using the numeric keypad. Regular number keys (in the upper row of the keyboard) will not work. Make sure that Num Lk is on.



### Other Keyboards

If your keyboard is damaged or you just want to make a change, you can use any standard USB keyboard. The system will detect and enable it automatically. However special functions/hot-keys unique to the system's regular keyboard may not work.

### Num Lk & Scr Lk

Hold down the **Fn Key** and either Num Lk or Scr Lk to enable number or scroll lock, and check the LED indicator for status.

Figure 1 - 5 - Keyboard - Models A & B



### Other Keyboards

If your keyboard is damaged or you just want to make a change, you can use any standard USB keyboard. The system will detect and enable it automatically. However special functions/hot-keys unique to the system's regular keyboard may not work.

### NumLk & ScrLk

Hold down the **Fn Key** and either **NumLk** or **ScrLk** to enable number or scroll lock, and check the LED indicator for status.

## Illuminated Keyboard - Model C

The keyboard has an embedded numerical keypad for easy numeric data input, and function keys to change operational features instantly.

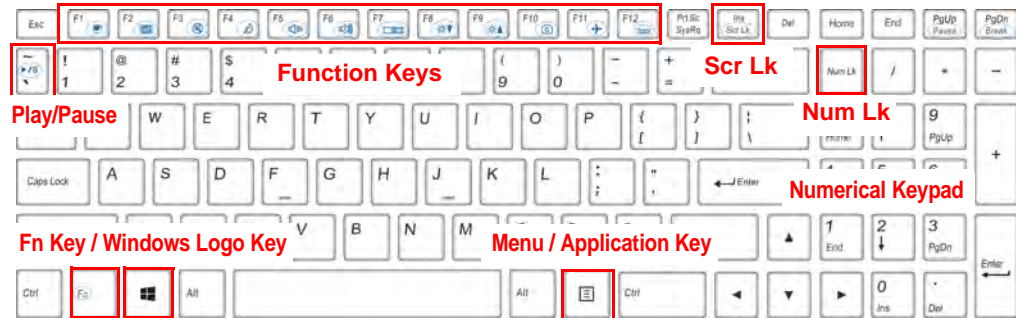

*Note that the F12 key (to toggle illuminated keyboard brightness in combination with the Fn key) is applicable to illuminated keyboards only, and will not appear on non-illuminated keyboards.*

Figure 1 - 6 - Illuminated Keyboard



### Special Characters

Some software applications allow the number-keys to be used with **Alt** to produce special characters. These special characters can only be produced by using the numeric keypad. Regular number keys (in the upper row of the keyboard) will not work. Make sure that **NumLk** is on.

## Keyboard Shortcuts

The following Windows Logo Key (Winkey) keyboard shortcuts are useful for navigation/operation in *Windows 8.1*.



Windows Logo  Key +	Description
Tap Winkey	Toggle between the <b>Start</b> screen and the foremost running app or the <b>Windows Desktop</b>
C	Display <b>Charms</b> menu
D	Switch to the <b>Windows Desktop</b> and toggle show Desktop
E	Switch to the Windows desktop and launch <b>Windows Explorer</b> with <b>Computer</b> displayed
F	Display file <b>Search</b>
I	Open the <b>Settings</b> charm
K	Open the <b>Connect</b> charm
L	Lock the computer and display the <b>Lock screen</b>
P	Display the <b>Second Screen</b> menu (see <a href="#">Figure 1 - 24 on page 1 - 33</a> )
R	Switch to the <b>Windows Desktop</b> and display the <b>Run</b> dialog box
Z	Access the <b>Customize Bar</b> (see <a href="#">Figure 1 - 15 on page 1 - 25</a> )

Table 1 - 5 - Keyboard Shortcuts



### Windows Logo Keyboard Shortcut

Use the Windows logo key  + **D** key combination to switch between the Start screen and Windows Desktop.

















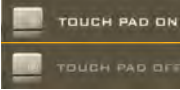

### Menu/Application Keyboard Shortcut

When the Desktop app is running you can use the Menu/Application key  on the keyboard to display the context menu as per a mouse right-click. In the Start screen this function is useful to quickly display the **All Apps** icon.

## Quick Start Guide

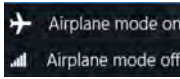
### Function Keys & Visual Indicators

The **function keys** (F1 - F12 etc.) will act as **hot keys** when pressed while the **Fn** key is held down. Visual indicators (see the table below) are available (in the **Windows Desktop app**) when the Hot Key driver is installed.

Keys	Function/Visual Indicators	Keys	Function/Visual Indicators
Fn + 	Fan Control Toggle Automatic / Full Power 	Fn +  	Volume Decrease/Increase
Fn + 	Play/Pause (in Audio/Video Programs)	Fn + 	Display Toggle
Fn + 	<b>Control Center</b> Toggle (see over)	Fn +  	Brightness Decrease/Increase
Fn + 	Touchpad Toggle 	Fn + 	PC Camera Power Toggle 
Fn + 	Turn LCD Backlight Off (Press a key to or use Touchpad to turn on)	Fn + 	Airplane Mode Toggle 
Fn + 	Mute Toggle	Fn +  *	Toggle Keyboard Illumination/Adjust Brightness Level (*for illuminated keyboards only)
Fn + 	Sleep Toggle	<b>Table 1 - 6 - Function Keys &amp; Visual Indicators</b>	

## Control Center





When in the Windows Desktop App (not in the Start screen) press the **Fn + Esc** key combination, Control Center Launch  button (toggles the Control Center On/Off) or **double-click the icon**  in the **notification area of the taskbar** to launch the **Control Center**. The Control Center gives quick access to frequently used controls and enables you to quickly turn the camera/touch pad on/off (see [Appendix B](#) for full details).



Figure 1 - 7 - Control Center

### Control Center Access

To run the Control Center press the **Fn + Esc** key combination, Control Center Launch button , or double-click the icon  in the notification area of the taskbar.

Close the Control Center by clicking the  close icon in the top right of the panel (move the cursor onto the top right corner of the panel to highlight it).

The Control Center Launch button  toggles the Control Center on/off.

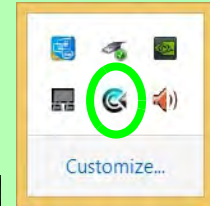

## Quick Start Guide

Figure 1 - 8  
Front & Left Views

1. LED Indicators
2. Security Lock Slot
3. USB 2.0 Port
4. S/PDIF-Out Jack
5. Microphone-In Jack
6. Headphone-Out Jack
7. Optical Device Drive Bay

## System Map: Front & Left Views



### Sound Blaster Cinema Audio

Note that **you will need to install the Sound Blaster audio application in order to get maximum audio performance.**



### CD/DVD Emergency Eject

If you need to manually eject a CD/DVD (e.g. due to an unexpected power interruption) you may push the end of a straightened paper clip into the emergency eject hole. Do not use a sharpened pencil or any object that may break and become lodged in the hole. Don't try to remove a floppy disk/CD/DVD while the system is accessing it. This may cause the system to "crash".

### Disk Eject Warning

Don't try to eject a CD/DVD while the system is accessing it. This may cause the system to "crash". Stop the disk first then eject it, or press the stop button twice.



## System Map: Right & Rear Views



Figure 1 - 9  
Right & Rear Views

1. Multi-In-1 Card Reader
2. 2 \* USB 3.0 Ports
3. Combined eSATA/USB 3.0 Port
4. HDMI-Out Port
5. RJ-45 LAN Jack
6. External Monitor Port
7. DC-In Jack
8. Vent/Fan Intake



### Multi-In-1 Card Reader

The card reader allows you to use the most popular digital storage card formats:

MMC (MultiMedia Card) / RS MMC  
SD (Secure Digital) / Mini SD / SDHC / SDXC  
MS (Memory Stick) / MS Pro / MS Duo

The card reader features a push-in/push-out card insertion and ejection mechanism. Simply push the card to insert and eject it, however Ms Duo cards require an adapter.

### USB 3.0 Port OR USB 2.0 Port

This model includes 1 \* USB 2.0 port and 3 \* USB 3.0 ports (including one combo e-SATA/USB 3.0 port). USB 3.0 ports are denoted by their **blue color**; USB 2.0 ports are colored black.



### HDMI Port

Note that the HDMI Port supports video and audio signals to attached external displays. Note that Sound Blaster audio will be disabled when you are connecting to an external display through an HDMI connection (see page 6 - 71).

Figure 1 - 10  
Bottom View  
Models A & C

1. Component Bay Cover
2. Battery
3. Primary HDD Bay
4. Fan Outlet/Intake



### Battery Information

Always completely discharge, then fully charge, a new battery before using it. Completely discharge and charge the battery at least once every 30 days or after about 20 partial discharges. See [“Battery Information” on page 3 - 14](#) for full instructions.

## System Map: Bottom View - Models A & C

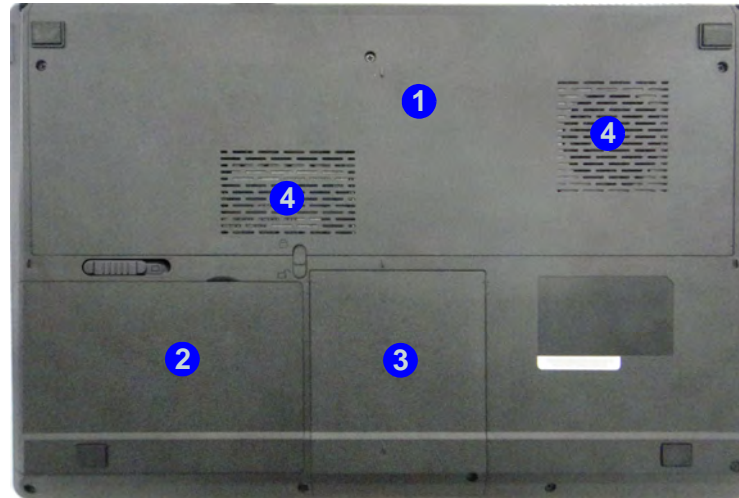

### Overheating

To prevent your computer from overheating make sure nothing blocks the Vent/Fan Intake while the computer is in use.



### Bottom Cover Removal Warning

Do not remove any cover(s) and/or screw(s) for the purposes of device upgrade as this may violate the terms of your warranty.

If you need to replace/remove the hard disk/RAM/optical device etc., for any reason, please contact your distributor/supplier for further information.

## System Map: Bottom View - Model B



### Overheating

To prevent your computer from overheating make sure nothing blocks the Vent/Fan Intake while the computer is in use.

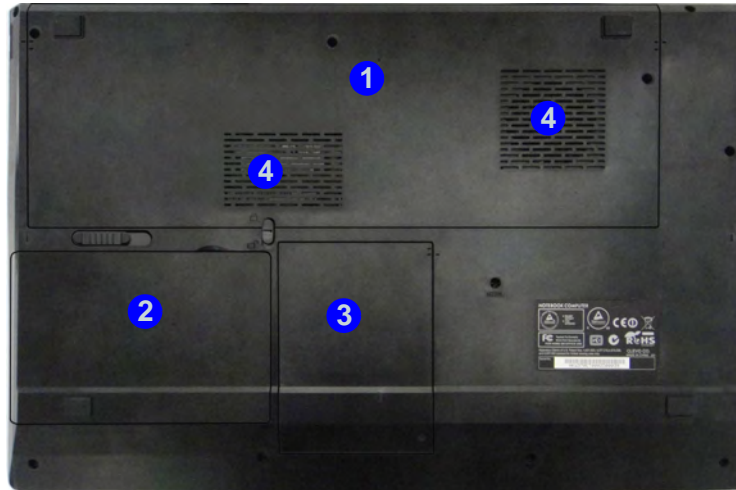

Figure 1 - 11  
Bottom View  
Model B

1. Component Bay Cover
2. Battery
3. Primary HDD Bay
4. Fan Outlet/Intake



### Battery Information

Always completely discharge, then fully charge, a new battery before using it. Completely discharge and charge the battery at least once every 30 days or after about 20 partial discharges. See [“Battery Information” on page 3 - 14](#) for full instructions.



### Bottom Cover Removal Warning

Do not remove any cover(s) and /or screw(s) for the purposes of device upgrade as this may violate the terms of your warranty.

If you need to replace/remove the hard disk/RAM/optical device etc., for any reason, please contact your distributor/supplier for further information.



### Windows Versions

Note that the information included on the following pages is for **Windows 8.1 only**.

The **Windows 8** interface is slightly different in appearance and in methods of navigation, and a separate manual is provided on the *Device Drivers & Manual Disc* with reference to **Windows 8**.

## Windows 8.1 Control Panel

Throughout this manual you will see an instruction to open the **Control Panel**. Right-click the lower left hot corner to bring up the context menu (or use the **Windows Logo Key**  + **X** key combination) and select **Control Panel** in both the **Desktop app** or **Start screen**.

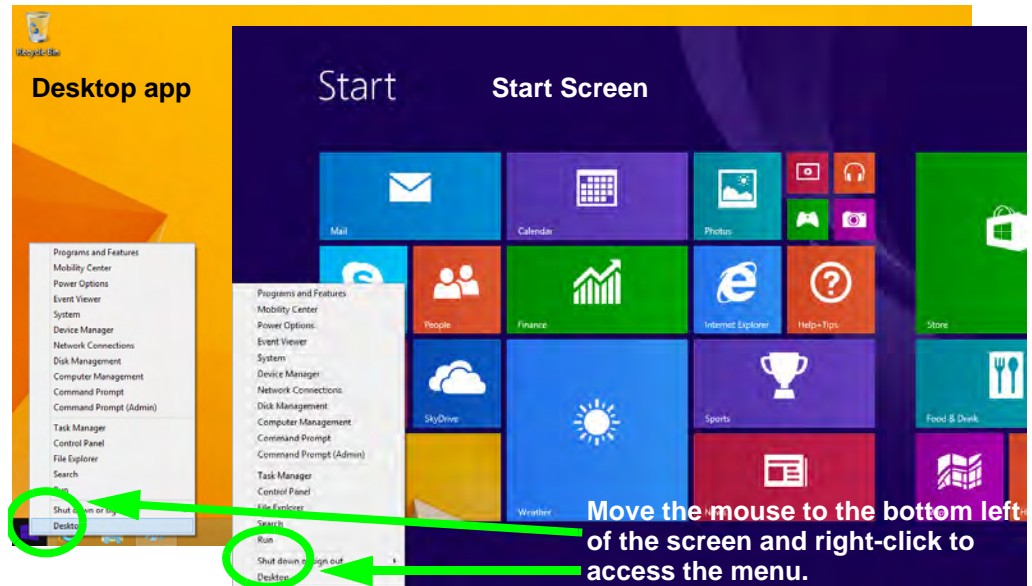

Move the mouse to the bottom left of the screen and right-click to access the menu.

**Right-click** the **Start button** in the **Desktop** app (or use the **Windows Logo Key** + **X** key combination) to bring up an advanced context menu of useful features such as Control Panel, Programs and Features, Power Options, Task Manager, Search, File Explorer, Command Prompt, Device Manager and Network Connections etc.

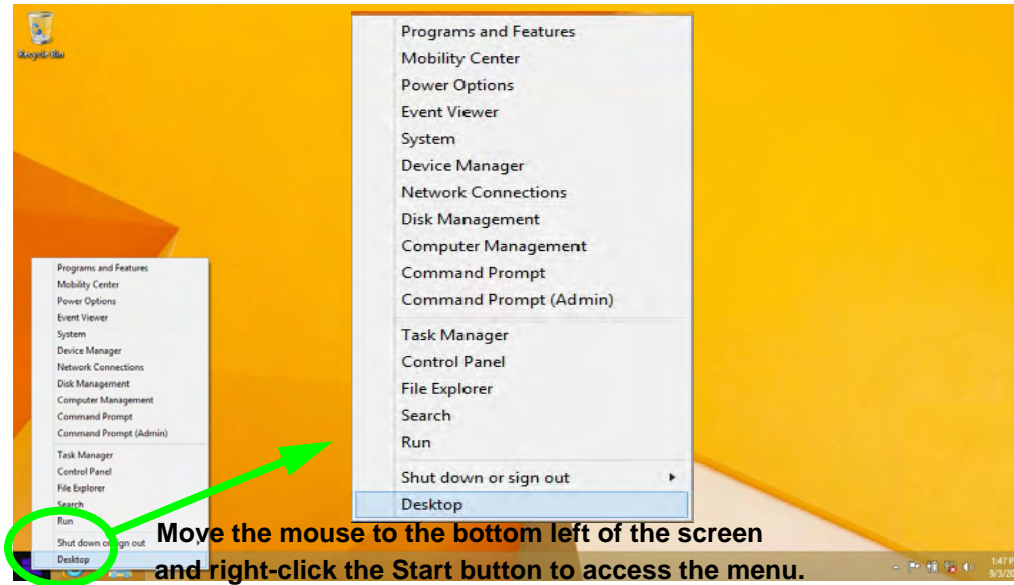

Figure 1 - 13 - Advanced Context Menu (Right-Click Start Button)



### Display Most Recently Used Apps

If you are in the **Start** screen, **Desktop** or an app you can move your mouse to the upper left corner of the screen to get back to the most recently used app.

To view all the most recently used Apps hover over the top left of the screen and then move the mouse down along the left side of the screen to display the list.

## Windows 8.1 Start Screen & Desktop

The Apps, control panels, utilities and programs within *Windows* are accessed from the **Start screen** and/or **Windows Desktop app**. The **Desktop** (which runs as an app within the **Start screen**) can be accessed by clicking the **Desktop** item in the **Start screen** (or by using the **Windows Logo Key**  + **D** key combination). Click the arrow at the bottom of the **Start screen** to access **Apps**.



Figure 1 - 14 - Windows Start Screen

## Apps & Tiles

The **Start** screen will contain a number of apps, and many more will be installed as you add more applications etc. Not all of these apps can fit on one screen so you will often need use the **slider** at the bottom of the screen in order to view all the necessary Apps.

### Accessing Pining/Unpinning All Apps

You can add and remove the tiles for apps and control panels in the Start screen. **Right-click on a blank area of the Start screen**, and you will see the **Customize** icon. Click the **Customize** icon to display all the installed applications etc. Right-click any icon to bring up the menu at the bottom of the screen and you can then click the appropriate icon to **pin the App** to (or unpin from) the **Start** screen, or to the **taskbar** in the **Desktop application** (you can also open the app in a new window, run as administrator or open the file location).

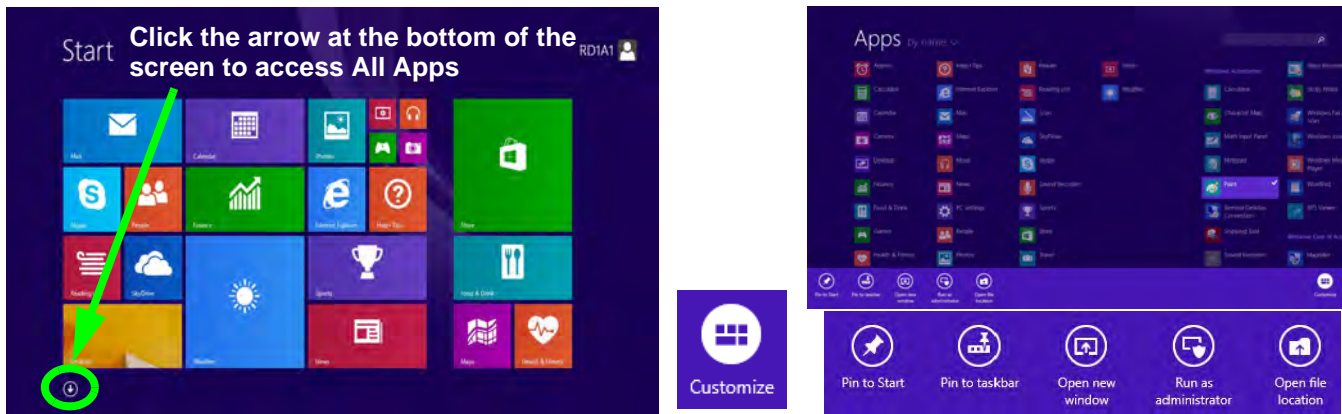



Figure 1 - 15 - Customize Apps

## Quick Start Guide

### Desktop Application

When the **Desktop** app is running (click the app in the **Start** screen or use the **Windows Logo Key**  + **D** key combination) you can use lower left hot corner to switch between the **Start** screen and the **Windows Desktop** app. To do so move your mouse to hover over the bottom left corner of the **Desktop** app and left-click.

When you move to the lower left hot corner in the **Start** screen it will take you back to your most recently used app (if one is running).

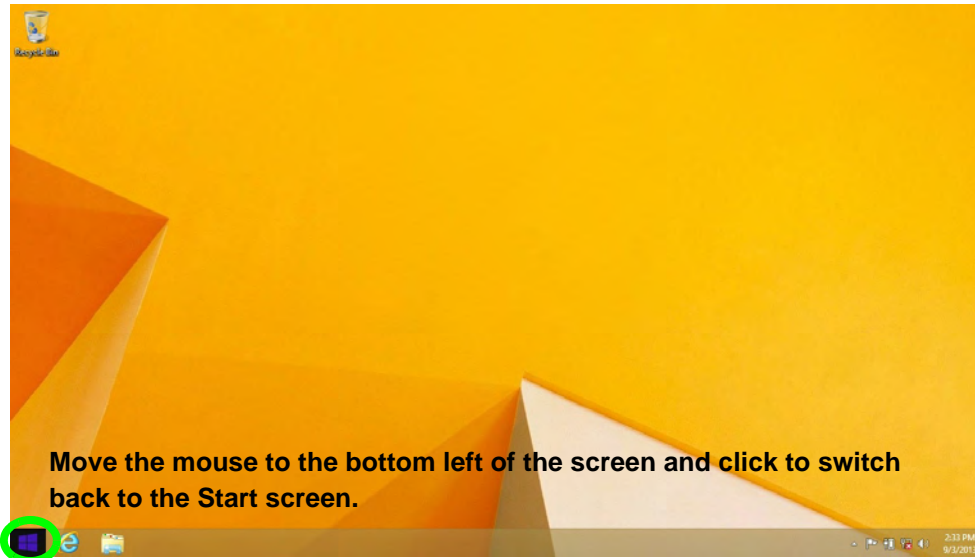

Figure 1 - 16 - Desktop



## The Charms Bar







The right side of the screen displays the **Charms Bar**. The **Charms Bar** contains the **Search**, **Share**, **Start**, **De-**  
**vices** and **Settings** menus. To access up the **Charms Bar** move the cursor to the upper or lower right corners of the screen, and then hover over one of the items in the **Charms Bar** to activate it (the bar will be black when it is active), or use the **Windows Logo Key**  + **C** key combination.

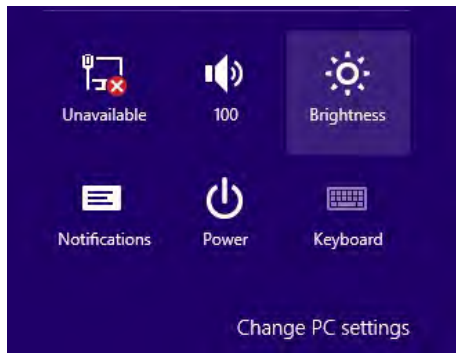



Figure 1 - 17 - Start Screen with Charms Bar

## Quick Start Guide

### Charms Bar Items

- **Search** : You can search for any file, application, Apps and control panel settings with instantaneous results.
- **Share** : This button is used to share information with people via mail or social networks.
- **Start** : Click to bring up the **Start** screen (the same function as pressing the Windows Logo Key or clicking the bottom left of the screen).
- **Devices** : Click this button to change connected peripheral device settings e.g. an external display.
- **Settings** : This button gives instant access to the computer settings, such as Network, Audio, Notifications, Power and Keyboard (click **Change PC Settings** to activate the PC Settings menu).





### Charms Bar - TouchPad Access

To quick access the **Charms Bar** using the TouchPad:

1. Place your finger **off** the TouchPad (slightly to the right of the pad resting on the computer).
2. Move your finger across to the left on to the TouchPad.
3. The Charms Bar will then pop-up.

Figure 1 - 18 - Settings Menu

## Windows 8.1 Control Panel

In many instances throughout this manual you will see an instruction to open the **Control Panel**. The Control Panel can be accessed in a number of ways in *Windows 8.1*.

- Click **Search** in the **Windows Charms Bar** (see previous page) and the search pane will pop out. Type *Control Panel* and select it from the results to the left.

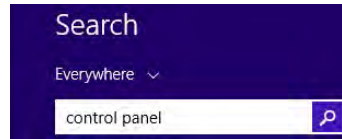

Figure 1 - 19 - Search (Control Panel)

- Click on **This PC** (in Apps, or you can to pin **This PC** to the **Start** screen), click on **Computer** in the top menu and select **Open Control Panel** from the ribbon.

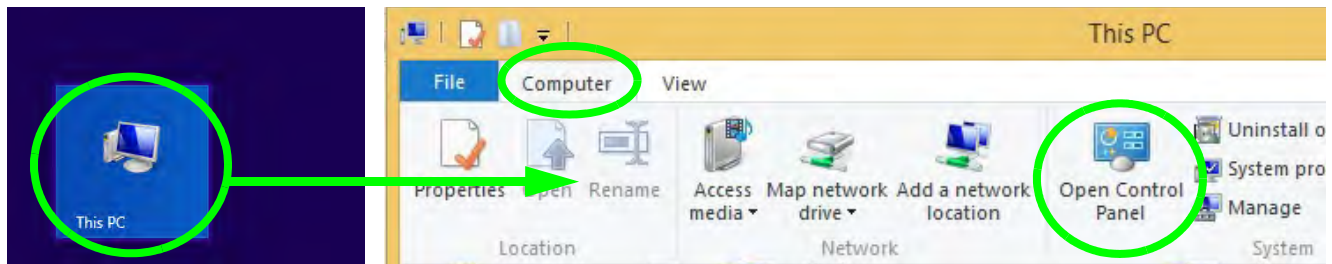

Figure 1 - 20 - Open Control Panel (Computer)

## Quick Start Guide

- When in the **Desktop** app (this does not apply to the Start screen) click on **Settings** in the **Windows Charms Bar** and select **Control Panel** from the menu.

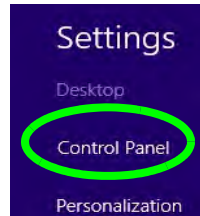

Figure 1 - 21 - Settings Charms Bar (Desktop App Only)

- Click the arrow at the bottom of the Start screen and click **Control Panel** in **Apps (Windows System)**.

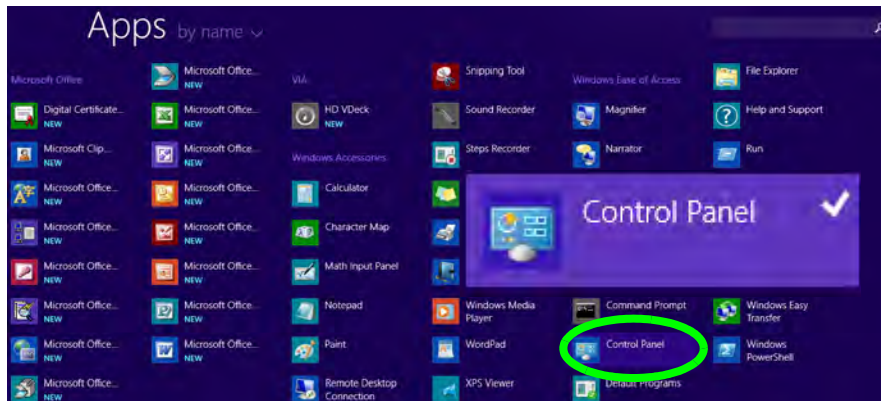



Figure 1 - 22 - All Apps - Control Panel

- Right-click the **Start** button to bring up the menu and select Control Panel (see *Figure 1 - 13 on page 1 - 23*).



### Keyboard Shortcut to Control Panel

You can also use keyboard shortcuts to access the Control Panel. Press the **Windows logo key**  and **X** to bring up the context menu, and then press **P** to bring up the Control Panel. Alternatively press the **Windows logo key**  and **R** to bring up the **Run** dialog box, and then type "**Control Panel**" and press Enter to access the Control Panel.

## Windows 8.1 Taskbar

In many instances throughout this manual you will see an instruction to access the **notification area of the taskbar (system tray)**. In *Windows 8.1* the taskbar is accessed from the **Desktop** application; if you are in the **Start** screen you will need to switch to the Desktop.

The taskbar is displayed at the bottom of the **Desktop** screen, and you can see the **notification area (system tray)** of the taskbar in the bottom right of the screen. Some of the control panels and applications referred to during the course of this manual can be accessed from here.



Figure 1 - 23 - Desktop Taskbar & Notification Area (System Tray)

You can pin/unpin apps to/from the taskbar in much the same way as you can to the **Start** screen (see *“[Accessing Pining/Unpinning All Apps” on page 1 - 25](#)”).*

# Video Features

## Microsoft Hybrid Graphics

**Microsoft Hybrid Graphics** is a seamless technology designed to get best performance from the graphics system while allowing longer battery life, without having to manually change settings. The computer will **automatically** switch between the **integrated** UMA (Unified Memory Architecture) GPU (**iGPU**) and the **discrete** GPU (**dGPU**) when required by the applications in use.

You can switch display devices, and configure display options, from the **Display** control panel (in **Appearance and Personalization**) when running the **Desktop** app (see *“Desktop Application” on page 1 - 26* and *Appendix C*). It is possible to quickly configure external displays from the **Devices** menu item in the **Charms Bar** (see *“The Charms Bar” on page 1 - 27*).

### To Configure Displays from Devices (Charms Bar):

1. Attach your display to the appropriate port, and turn it on.
2. Go the **Charms Bar**, select **Devices**.
3. Click **Project** (you may need to click **Second Screen**).
4. Click on any one of the options from the menu to select **PC screen only**, **Duplicate**, **Extend** or **Second screen only**.

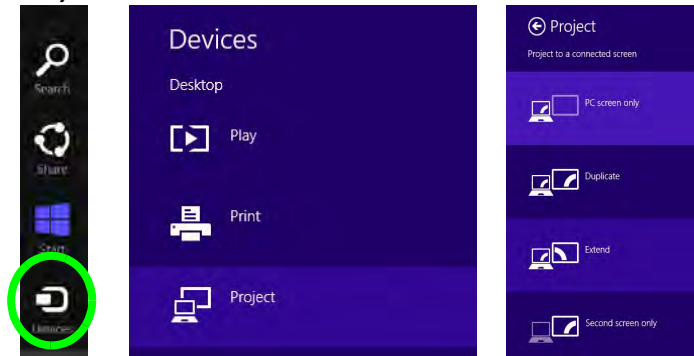
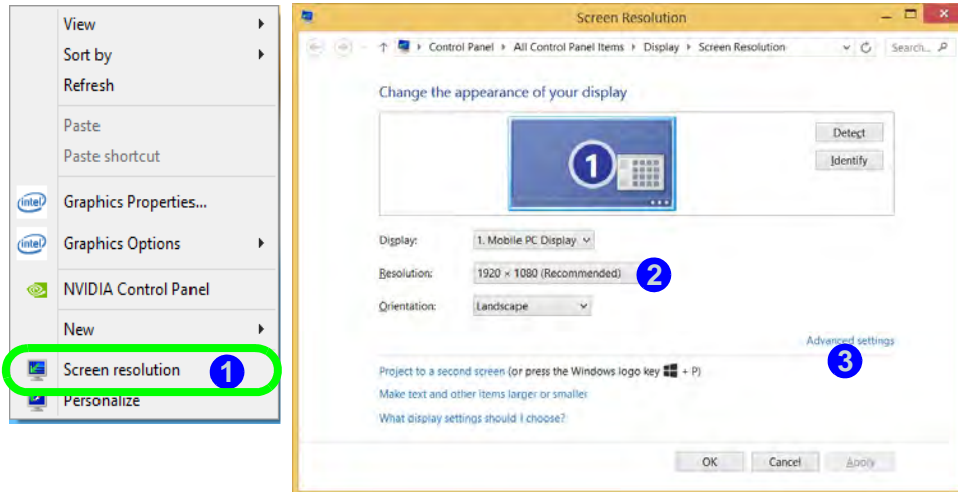

Figure 1 - 24 - Devices (Project)

## Quick Start Guide

To access **Display (Control Panel)** and **Screen Resolution** in *Windows*:

1. Go to the **Control Panel**.
2. Click **Display** (icon) - In the **Appearance and Personalization** category.
3. **Adjust resolution.**



### Right-Click Desktop App

1. You can right-click the desktop and select **Screen resolution** **1** (*Figure 1 - 25*).
2. Use the drop box to select the screen **Resolution** **2** (*Figure 1 - 25*).
3. Click **Advanced settings** **3** (*Figure 1 - 25*) to bring up the **Advanced** properties tabs.

Figure 1 - 25 - Screen Resolution



To access the *Intel(R) HD Graphics Control Panel*:

1. Click **Advanced settings** ③ (*Figure 1 - 25 on page 1 - 34*) in the **Screen Resolution** control panel in **Windows**.
  2. Click the **Intel(R)...** tab and click **Graphics Properties** (button) ④ (*Figure 1 - 26 on page 1 - 35*).
- OR**
3. Right-click the desktop and select **Graphics Properties** from the menu.
- OR**
4. Click the icon  in the notification area of the Desktop taskbar and select **Graphics Properties** from the menu.

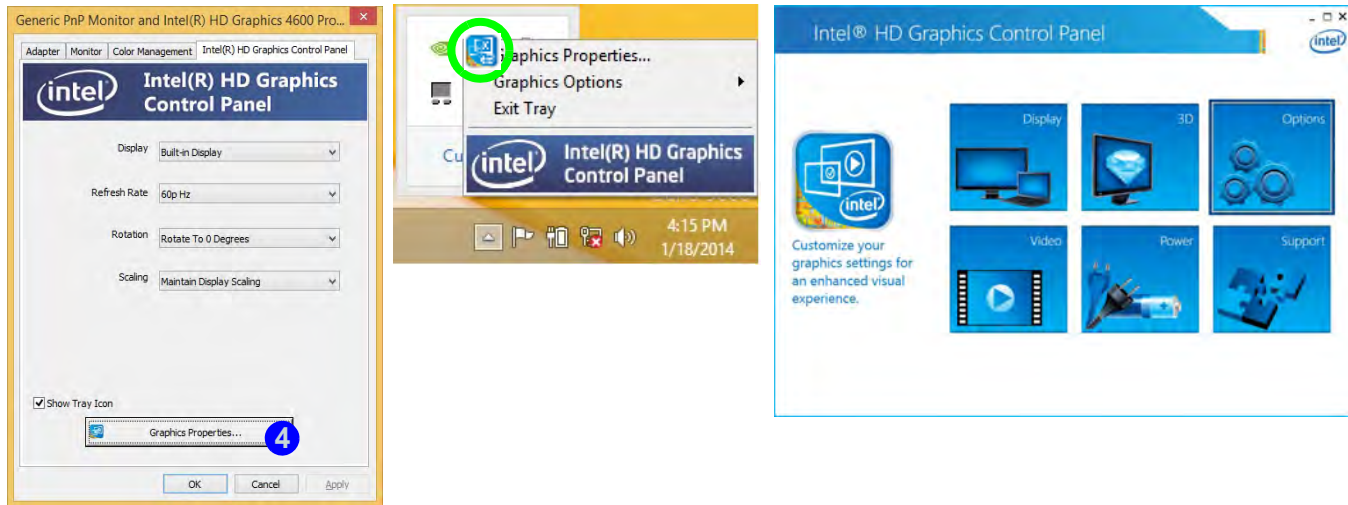

Figure 1 - 26 - Intel Graphics Control Panel

## Quick Start Guide

To access the *NVIDIA Control Panel*:

1. Right-click the desktop and select **NVIDIA Control Panel** 5 (Figure 1 - 27).
- OR
2. Double-click the icon 6 (Figure 1 - 27) in the *Windows* control panel.

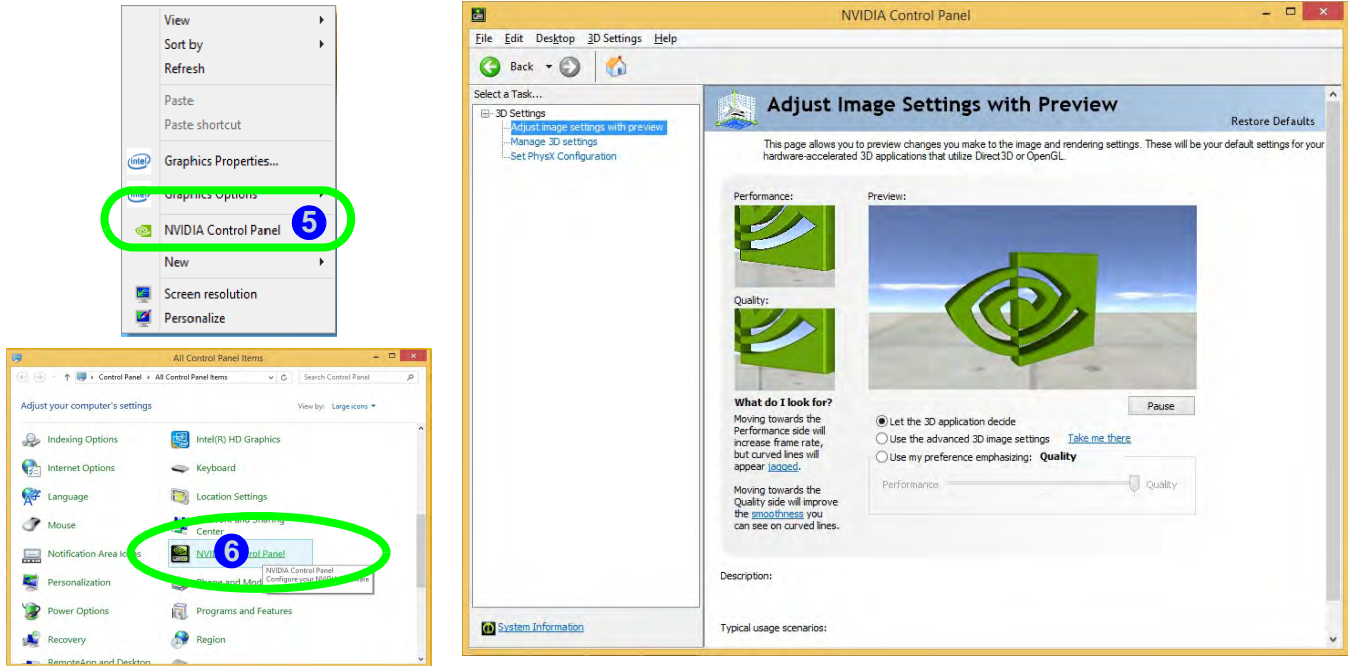

Figure 1 - 27 - NVIDIA Control Panel

## Power Options

**Power Options (Hardware and Sound)** can be accessed from the Control Panel. The **Power Menu** item in **Settings** in the **Charms Bar** in *Windows 8.1* may be used to **Shut down** or **Restart** (you can also add **Hibernate/Sleep** to the menu - see *“Adding Hibernate/Sleep to the Power Menu” on page 3 - 10*). You can also use the context menu (**Shut down or sign out**) shut the computer down/restart etc.

### Shut Down, Restart or Sleep (Charms Bar)

1. Go to the **Charms Bar** and click **Settings**.
2. Click **Power** .
3. Select **Sleep**, **Shut Down** or **Restart**.

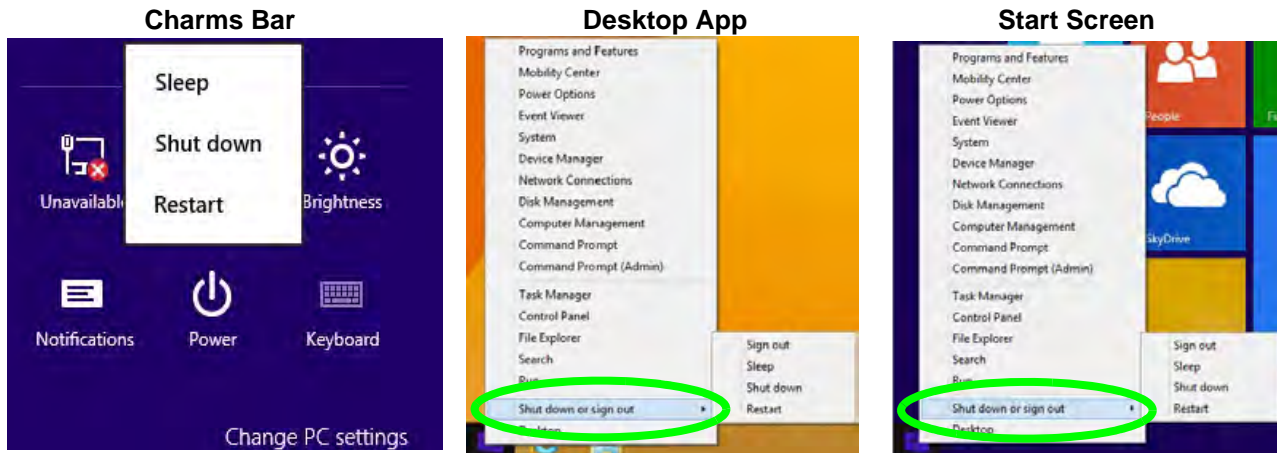

Figure 1 - 28 - Shut Down/Restart

# Running Apps

To run apps in *Windows 8.1* you will need to check that the **Screen Resolution** and **User Account Control Settings** are compatible with the system requirements.

## Screen Resolution Settings

1. Switch to the Windows Desktop (click the app or use the Windows logo key **+** **D** key combination).
2. Right-click a blank area of the Windows Desktop and select **Screen Resolution**. Adjust the **Resolution** to make sure that it is at least **1024 \* 768**, although preferably **1366 \* 768** or above (see sidebar).

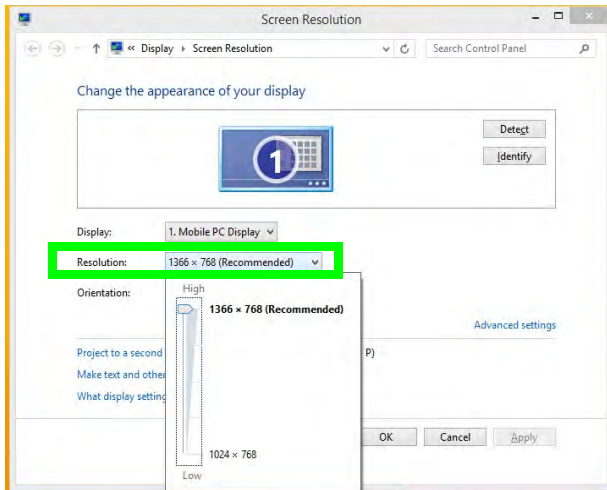

  
**Screen Resolution for Apps  
(Windows 8.1)**

The minimum resolution in which Apps will run is **1024x768**.

The minimum resolution required to support all the features of Windows 8 (including multitasking with snap) is **1366x768**.

These specs are the minimum screen resolution that supports all the features of Windows 8.1 on a useful physical size.

Figure 1 - 29 - Screen Resolution

## User Account Control Settings

If your computer meets the minimum screen resolution requirements, and still you can't run apps, then that you have to check the status of **User Account Control** (UAC). Apps may fail to open when the UAC is turned off. To check whether the UAC is on or off, follow the instructions below.

1. Open the **Control Panel**.
2. Click on **User Accounts** and then click on **Change User Account Control settings** (or click **System and Security** and click **Change User Account Control Settings** under **Action Center**).
3. If the slider is in the **Never notify** position, then the UAC is disabled.
4. To enable or turn on the UAC, move the slider to **Always notify** or **Notify me when apps try to make changes to my computer (default)** position, and then click **OK**.

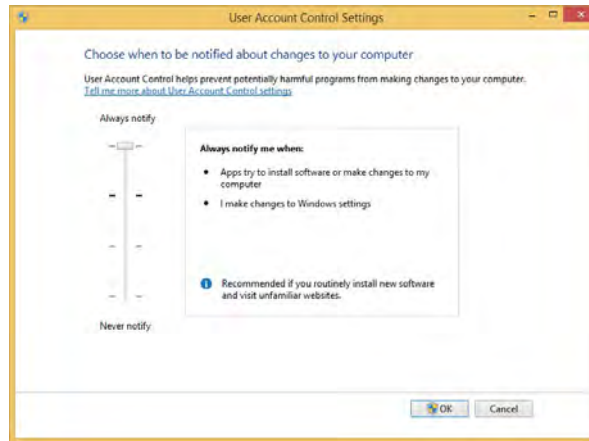

Figure 1 - 30 - User Account Control



# Chapter 2: Storage Devices, Audio & Mouse

## Overview

Read this chapter to learn more about the following main features and components of the computer:

- Hard Disk Drive
- Optical Device
- Multi-in-1 Card Reader
- Audio Features
- Touchpad and Buttons/Mouse



### Power Safety

Before attempting to access any of the internal components of your computer please ensure that the machine is not connected to the AC power, and that the machine is turned off. Also ensure that all peripheral cables, including phone lines, are disconnected from the computer.

## Hard Disk Drive

The hard disk drive(s) is(are) used to store your data in the computer. The hard disk(s) can be taken out to accommodate other 2.5" serial (SATA) hard disk drives with a height of 9.5 mm. The hard disk(s) is(are) accessible after removing the hard disk bay cover (**primary hard disk drive**) or component bay cover (**secondary hard disk drive**) from the bottom of your computer as seen below.

Further details on removing and inserting the hard disk are available in *“Upgrading the Hard Disk Drive(s)” on page 6 - 8.*



Primary HDD



Secondary HDD

*Figure 2 - 1*  
Hard Disk Location



## Optical Device

There is a bay for a 5.25" optical (CD/DVD) device (12.7mm height). The actual device will depend on the model you purchased (see *“Storage” on page D - 3*). The optical device is usually labeled **“Drive D:”** and may be used as a boot device if properly set in the **BIOS** (see *“Boot Menu” on page 5 - 14*).

### Loading Discs

To insert a CD/DVD, press the open button **1** and carefully place a CD/DVD onto the disc tray with label-side facing up (use just enough force for the disc to click onto the tray’s spindle). Gently push the CD/DVD tray in until its lock “clicks” and you are ready to start. The busy indicator **2** will light up while data is being accessed, or while an audio/video CD, or DVD, is playing. If power is unexpectedly interrupted, insert an object such as a straightened paper clip into the emergency eject hole **3** to open the tray.



*Figure 2 - 2*  
Optical Device



### Sound Volume Adjustment

How high the sound volume can be set depends on the setting of the volume control within **Windows**. Click the **Volume** icon on the taskbar to check the setting (see *“Audio Features” on page 2 - 7*).



### CD Emergency Eject

If you need to manually eject a CD (e.g. due to an unexpected power interruption) you may push the end of a straightened paper clip into the emergency eject hole. However please do NOT use a sharpened pencil or similar object that may break and become lodged in the hole.

### Disk Eject Warning

Don't try to remove a CD/DVD while the system is accessing it. This may cause the system to "crash".

## Handling CDs or DVDs

Proper handling of your CDs/DVDs will prevent them from being damaged. Please follow the advice below to make sure that the data stored on your CDs/DVDs can be accessed.

Note the following:

- Hold the CD or DVD by the edges; do not touch the surface of the disc.
- Use a clean, soft, dry cloth to remove dust or fingerprints.
- Do not write on the surface with a pen.
- Do not attach paper or other materials to the surface of the disc.
- Do not store or place the CD or DVD in high-temperature areas.
- Do not use benzene, thinner, or other cleaners to clean the CD or DVD.
- Do not bend the CD or DVD.
- Do not drop or subject the CD or DVD to shock.

## DVD Regional Codes

To change the DVD regional codes:

1. Go to the **Control Panel**
2. Double-click **Device Manager (Hardware and Sound)**, then click the **+** next to **DVD/CD-ROM drives**.
3. Double-click on the DVD-ROM device to bring up the **Properties** dialog box, and select the **DVD Region** (tab) to bring up the control panel to allow you to adjust the regional code.

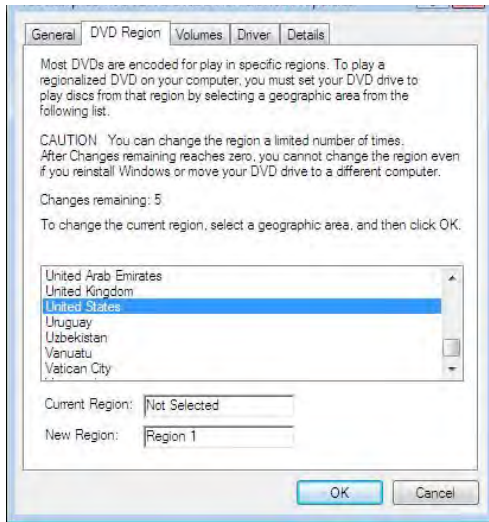

- **Region 1** - USA & Canada
- **Region 2** - Western Europe, Japan, South Africa, Middle East & Egypt
- **Region 3** - South-East Asia, Taiwan, South Korea, The Philippines, Indonesia, Hong Kong
- **Region 4** - South & Central America, Mexico, Australia, New Zealand
- **Region 5** - N Korea, Russia, Eastern Europe, India & Most of Africa
- **Region 6** - China



### DVD Region Note

DVD region detection is device dependent, not OS-dependent. You can select your module's region code 5 times. The fifth selection is permanent. This cannot be altered even if you change your operating system or you use the module in another computer.

*Figure 2 - 3*  
DVD Region Codes



### Push-Push Card Reader

The card reader features a push-in/push-out card insertion and ejection mechanism. Simply push the card to insert and eject it, however Ms Duo cards require an adapter.

## Multi-in-1 Card Reader

The card reader allows you to use some of the latest digital storage cards. Push the card into the slot and it will appear as a removable device, and can be accessed in the same way as your hard disk (s). Make sure you install the Card Reader driver (see *“Card Reader” on page 4 - 6*).

- MMC (MultiMedia Card) / RSMMMC
- SD (Secure Digital) / Mini SD / SDHC / SDXC
- MS (Memory Stick) / MS Pro / MS Duo



**Note:** Some of these cards require PC adapters that are usually supplied with the cards.

Figure 2 - 4  
Right View

1. Card Reader



## Audio Features

You can configure the audio options on your computer from the **Sound** control panel in *Windows*, from the **HD VDeck** icon on the desktop  or **VIA HD Audio Deck** control panel  .

The volume may also be adjusted by means of the **Fn + F5/F6** key combination.

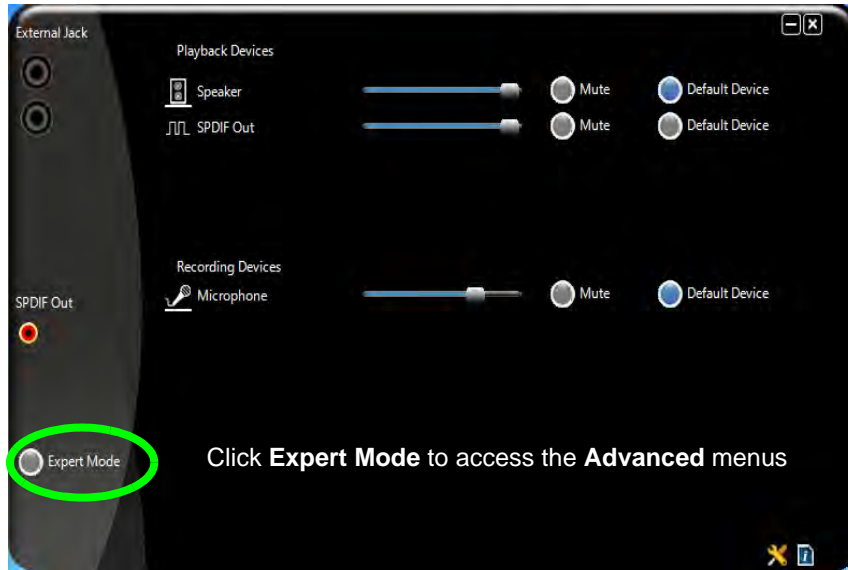

### Sound Volume Adjustment

The sound volume level is set using the volume control on the *Windows* desktop (and the **volume function keys F5/F6** on the computer). Click the volume icon in the taskbar to check the setting.

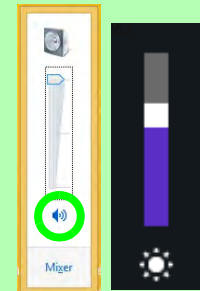

*Figure 2 - 5*  
VIA HD Audio Deck



### Syncing Left & Right Volume Balance

If you wish to adjust the left and right channel volume levels separately, you will need to adjust this from the **VIA HD Audio Deck in Expert Mode**.

Click **Speaker** in **VIA HD Audio Deck** (in Expert Mode) and click the **Sync Left and Right** volume button (see left). You can then adjust the volume sliders independently (this setting also controls the **Balance** setting in the Windows Sound control panel).

**Expert Mode** will allow you to access more advanced configuration menus for **Speaker, Microphone and Stereo Mix**.

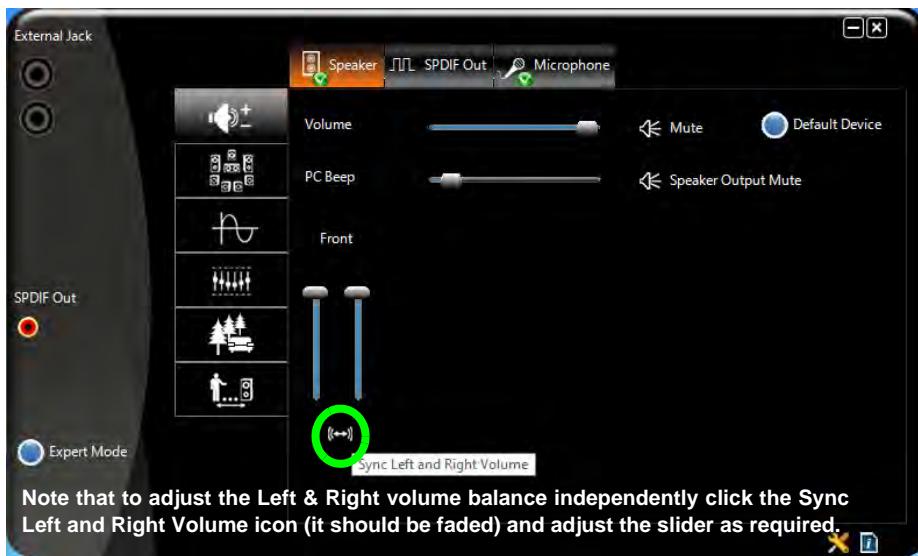

Note that to adjust the Left & Right volume balance independently click the Sync Left and Right Volume icon (it should be faded) and adjust the slider as required.



### Sound Blaster Cinema Audio

Note that you will need to install the **Sound Blaster Cinema** audio application in order to get maximum audio performance. See **"Sound Blaster Cinema EQ"** on page 6 - 67.

## Touchpad and Buttons/Mouse

The Touchpad is an alternative to the mouse; however, you can also add a mouse to your computer through one of the USB ports. The Touchpad buttons function in much the same way as a two-button mouse.

Once you have installed the Touchpad driver (see *“Touchpad” on page 4 - 6*) you can configure the functions by double-clicking the Touchpad driver icon  in the notification area of the taskbar. You may then configure the Touchpad tapping, buttons, scrolling (see sidebar), pointer motion and sensitivity options to your preferences. Use the **Fn + F1** key combination to toggle the Touchpad on/off.

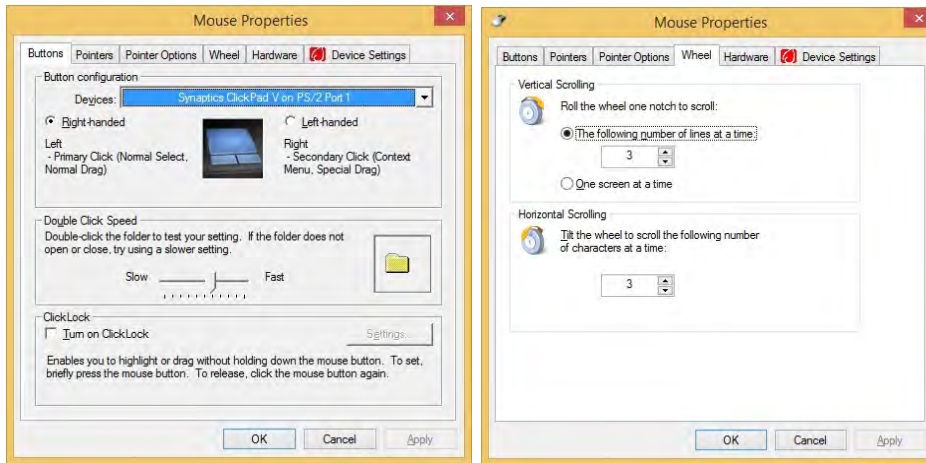

### Touchpad Scrolling

This computer model series may feature different Touchpad versions.

These Touchpads may differ in their vertical scrolling function in most scrollable windows.

Some Touchpads require sliding the finger up and down on the right of the Touchpad to scroll the window. Other versions require tapping/holding down the finger at the top right or bottom right of the Touchpad to scroll the window.

Figure 2 - 7  
Mouse Properties



### Show Video

You can get a clearer view of the gestures involved by clicking the **Show Video** option for each gesture item.

Select the gesture (**Pinch Zoom, Rotating, Three Fingers Down and Three Finger Flick**) in the **Device Settings > Settings** left tree menu and click the **Show Video** button to see the demonstration video.

For more details on any of the gestures see the **help** in the lower part of the right menu window.

## Gestures and Device Settings

The Synaptics Gestures Suite application allows you to use a specific gesture (action) on the surface of the Touchpad to perform specific actions to manipulate documents, objects and applications.

You can configure the settings from the Device Settings tab in **Mouse Properties**:

1. Click **Start**, and click **Control Panel** (or point to **Settings** and click **Control Panel**).
2. Click **Mouse (Hardware and Sound)**.
3. Click **Device Settings** (tab) and click **Settings**.
4. Use the menu tree on the left to access the user configurable settings.

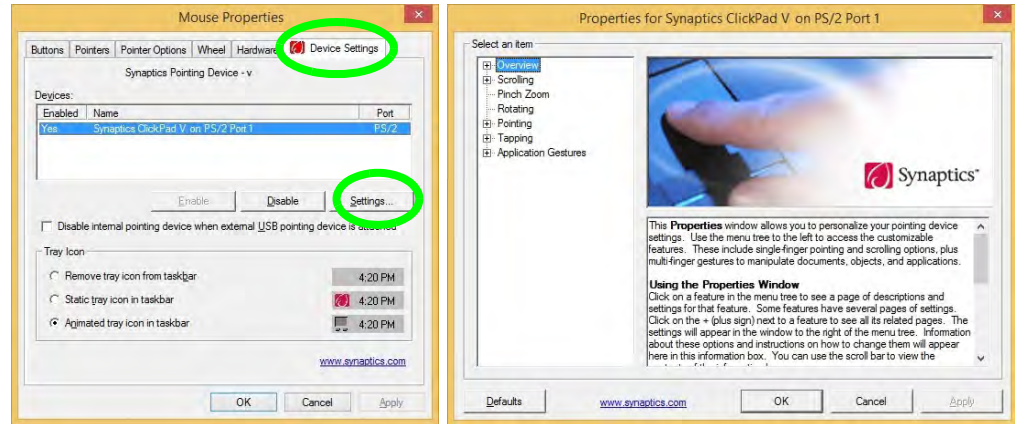

*Figure 2 - 8*  
**Mouse Properties - Device Settings**



## Disabling the Touchpad

If you need to disable the Touchpad for any reason (e.g. you may find that when using the computer's internal keyboard you accidentally trigger the Touchpad when resting your wrists or palms on it) you can do so by using **Fn + F1** key combination.

You can also set the system to automatically disable the internal Touchpad when an external USB point device (e.g. a USB mouse) is attached.

1. Go to the **Mouse Properties** control panel.
2. Click to select **Device Settings** (tab).
3. Click to place a check in the "**Disable internal pointing device when external USB pointing device is attached**" check box.
4. Click **OK** to save the setting.



*Figure 2 - 9*  
**Mouse Properties**  
**(Disable Touchpad)**



### PalmCheck

In order to improve Touchpad scrolling responsiveness when using one-finger scrolling, you can adjust the PalmCheck slider towards “Minimum” as per your preference.

However bear in mind that adjusting the slider too far towards “Minimum” can turn off PalmCheck altogether.

*Figure 2 - 10*  
**PalmCheck Slider**

### PalmCheck

The PalmCheck feature helps prevent operating the Clickpad/Touchpad by accident, by recognizing when your palm is resting on it or brushing its surface while you are typing.

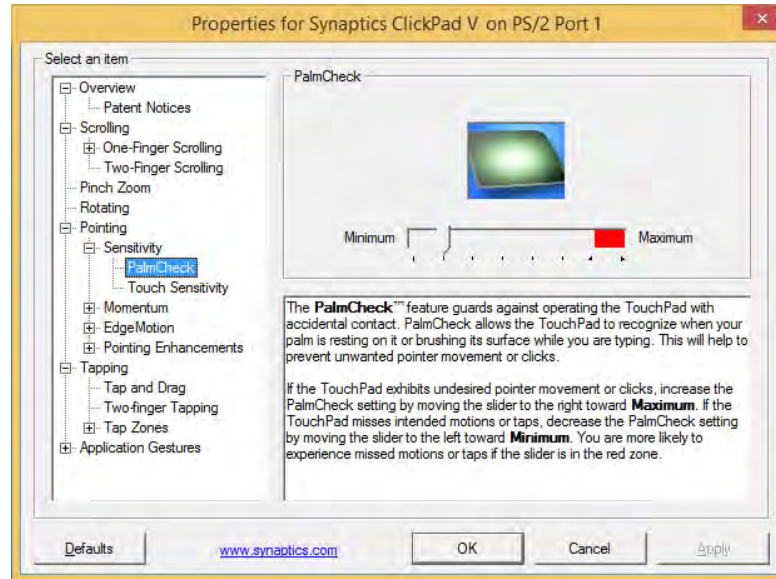

## Scrolling

The Two-Finger scrolling feature works in most scrollable windows and allows you to scroll horizontally and vertically. Place two fingers, slightly separated, on the Touchpad surface and slide both fingers in the direction required (in a straight continuous motion).



*Figure 2 - 11*  
**Scrolling Gesture**

## Zooming

The Pinch Zoom gesture can be used to perform the same function as a scroll wheel in *Windows* applications that support CTRL + scroll wheel zoom functionality. Place two fingers on the Touchpad (for best results use the tips of the fingers) and slide them apart to zoom in, or closer together to zoom out.



**Mouse Driver**

If you are using an external mouse your operating system may be able to auto-configure your mouse during its installation or only enable its basic functions. Be sure to check the device's user documentation for details.

*Figure 2 - 12*  
**Zooming Gesture**

### Rotating

Use the Pivot Rotate gesture to rotate objects (e.g. photos) in 90 degree increments. Place a finger down on the left “target” zone and keep it stationary. Place another finger near the middle of the Touchpad and slide it in a circular motion around the stationary finger (clockwise or counterclockwise) to rotate the object.

*Figure 2 - 13*  
**Rotating Gesture**



### Three Finger-Flick/Three Fingers Down (Press)

The Three Finger-Flick gesture may be used to enhance navigation with a variety of applications such as browsing the Internet or scrolling through a photo viewer. The Three Fingers Down gesture may be used to launch user-selectable applications.

*Figure 2 - 14*  
**Flick/Press**  
**Gesture**

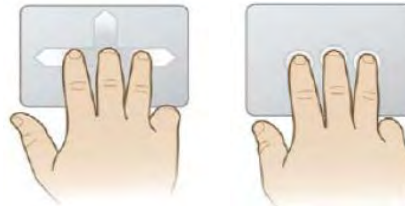

# Chapter 3: Power Management

## Overview

To conserve power, especially when using the battery, your computer power management conserves power by controlling individual components of the computer (the monitor and hard disk drive) or the whole system. This chapter covers:

- The Power Sources
- Turning On the Computer
- Power Plans
- Power-Saving States
- Configuring the Power Buttons
- Battery Information

The computer uses enhanced power saving techniques to give the operating system (OS) direct control over the power and thermal states of devices and processors. For example, this enables the OS to set devices into low-power states based on user settings and information from applications.



### OS Note

Power management functions will vary slightly depending on your operating system. For more information it is best to refer to the user's manual of your operating system.



#### Forced Off

If the system “hangs”, and the **Ctrl + Alt + Del** key combination doesn’t work, press the power button for **4 seconds**, or longer, to force the system to turn itself off.

## The Power Sources

The computer can be powered by either an AC/DC adapter or a battery pack.

### AC/DC Adapter

Use only the AC/DC adapter that comes with your computer. The wrong type of AC/DC adapter will damage the computer and its components.

1. Make sure the battery is inserted and locked in position.
2. Attach the AC/DC adapter to the DC-In jack at the rear of the computer, then plug the AC power cord into an outlet, and connect the AC power cord to the AC/DC adapter (**make sure you use the adapter when first setting up the computer**, as to safeguard the computer during shipping the battery will be locked to not power the system until first connected to the AC/DC adapter).
3. Use one hand to raise the lid/LCD to a comfortable viewing angle (**do not exceed 130 degrees**); use the other hand to support the base of the computer.
4. Press the power button on the top right of the computer **for about 2 - 3 seconds** to turn the computer “on”.

### Battery

The battery allows you to use your computer while you are on the road or when an electrical outlet is unavailable. Battery life varies depending on the applications and the configuration you're using. **To increase battery life, let the battery discharge completely before recharging** (see *“Battery FAQ” on page 3 - 19*).

We recommend that you do not remove the battery. For more information on the battery, please refer to *“Battery Information” on page 3 - 14*.

## Turning On the Computer

Now you are ready to begin using your computer. To turn it on simply press the power button on the front panel.

When the computer is on, you can use the power button as a Stand by/Hibernate/Shutdown hot-key button when it is pressed for less than **4 seconds** (pressing and holding the power button for longer than this will shut the computer down). Use **Power Options (Hardware and Sound)** in the *Windows* control panel to configure this feature.



### Power Button as Stand by or Hibernate Button

You can use the OS's "Power Options" control panel to set the power button to send the system into Stand by or Hibernate mode (see your OS's documentation, or "[Configuring the Power Buttons](#)" on page 3 - 9 for details).

## Shutting the Computer Down

Note that you should always shut your computer down by choosing the **Shut down** command as this will help prevent hard disk or system problems. Use the **Shut down or sign out** item in the **Context Menu** (right-click the lower left corner of the screen to bring up the menu).

You can also use the **Power Menu** in **Settings** in the **Windows 8.1 Charms Bar**. If you want to add Hibernate/Sleep to the Power Menu see *“Adding Hibernate/Sleep to the Power Menu” on page 3 - 10*.

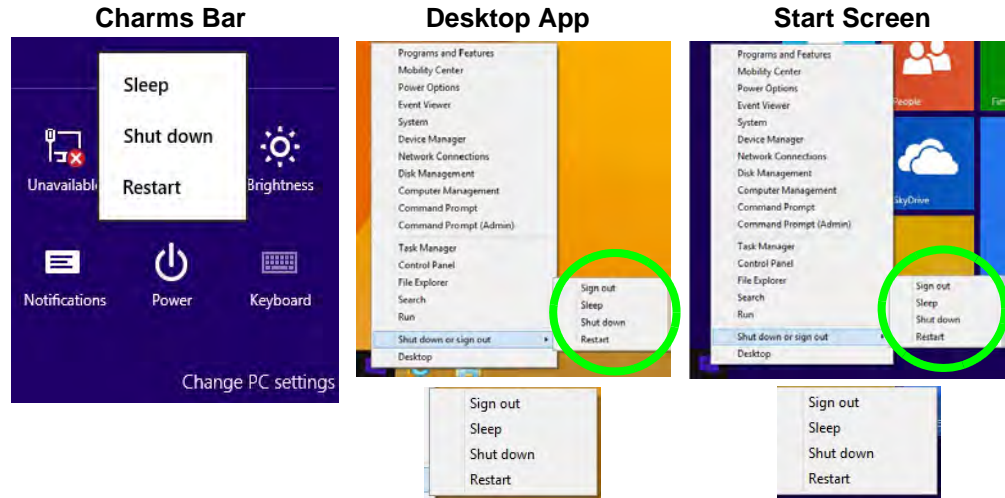

Figure 3 - 1  
Shut Down/Restart





# Power Plans

The computer can be configured to conserve power by means of **power plans**. You can use (or modify) an existing **power plan**, or create a new one.

The settings may be adjusted to set the **display** to turn off after a specified time, and to send the computer into **Sleep** after a period of inactivity.

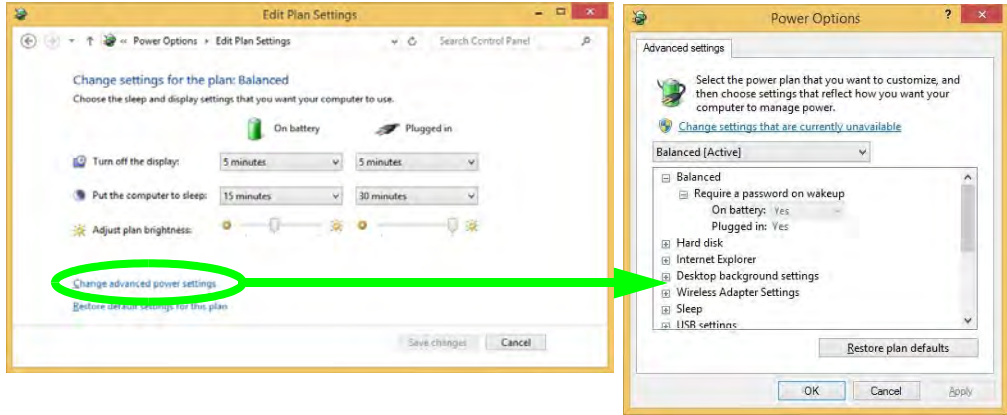
Click *Change plan settings* and then click *Change advanced power settings* to access further configuration options in **Advanced Settings**.





### Resuming Operation

See [Table 3 - 1, on page 3 - 11](#) for information on how to resume from a power-saving state.

### Password

It is recommended that you enable a password on system resume in order to protect your data.

Figure 3 - 2  
Power Plan  
Advanced Settings

## Power Management

3

Each **Windows power plan** will also adjust the processor performance of your machine in order to save power. This is worth bearing in mind if you are experiencing any reduced performance (especially under DC/battery power).

Choose **High performance** (you may need to click **Show additional plans** to view the High performance plan) for maximum performance when the computer is powered from an AC power source. Choose the **Power saver** (bear in mind that this scheme may slow down the overall performance of the computer in order to save power) for maximum power saving when the computer is battery (DC power) powered.

*Figure 3 - 3*  
**Power Plans**

Click to Show/Hide additional power plans

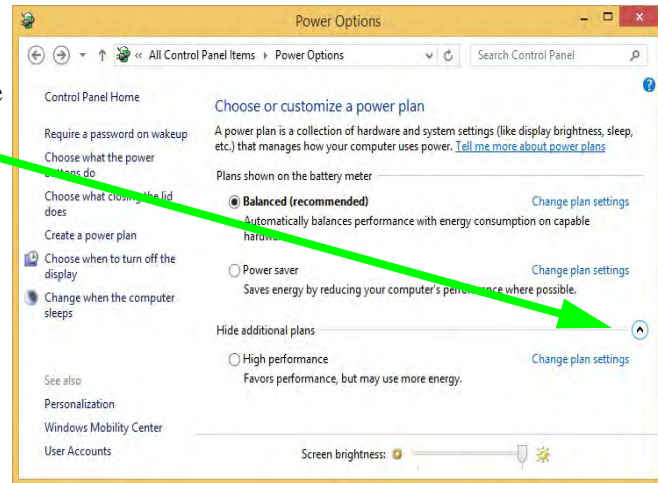

# Power-Saving States

You can use power-saving states to stop the computer’s operation and restart where you left off. *Win 8.1* uses the **Sleep**, **Hibernate** and **Shut Down** power-saving states.

## Sleep

In **Sleep** all of your work, settings and preferences are saved to memory before the system sleeps. When you are not using your computer for a certain length of time, which you specify in the operating system, it will enter **Sleep** to save power.

The PC wakes from **Sleep within seconds** and will return you to where you last left off (what was on your desktop) without reopening the application(s) and file(s) you last used.

If your mobile PC in **Sleep** is running on battery power the system will use only a minimum amount of power. After an extended period the system will save all the information to the hard disk and shut the computer down before the battery becomes depleted.

To add **Sleep** to the **Power Menu** see *“Adding Hibernate/Sleep to the Power Menu” on page 3 - 10.*



### Wake On LAN Support (Windows 8)

Wake-On-LAN is only supported from **Sleep** or **Hibernate** states in *Windows 8*.

If you require your computer to wake up from network activity in *Windows 8* then make sure that the computer is either in **Sleep** or **Hibernate**.

Wake-On-LAN is not supported from **Shut-down** states in *Windows 8*.

### Hibernate

**Hibernate** uses the least amount of power of all the power-saving states and saves all of your information on a part of the hard disk before it turns the system off. If a power failure occurs the system can restore your work from the hard disk; if a power failure occurs when work is saved only to memory, then the work will be lost. **Hibernate** will also return you to where you last left off within seconds. You should put your mobile PC into **Hibernate** if you will not use the computer for a period of time, and will not have the chance to charge the battery. To add **Hibernate** to the **Power Menu** see *“Adding Hibernate/Sleep to the Power Menu” on page 3 - 10*.

### Shut down

You should **Shut down** the computer if you plan to install new hardware (don't forget to remove the battery and follow all the safety instructions in **Chapter 6**), plan to be away from the computer for several days, or you do not need it to wake up and run a scheduled task. Returning to full operation from **Shut down** takes longer than from **Sleep** or **Hibernate**.

Figure 3 - 4  
Power Menu

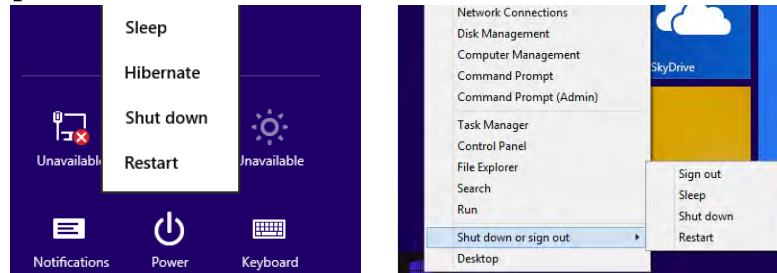

# Configuring the Power Buttons

The power/sleep button (**Fn + F4** key combo) and closed lid may be set to send the computer in to a power-saving state. Click **Choose what the power buttons do** on the left menu in **Power Options** to bring up the menu.

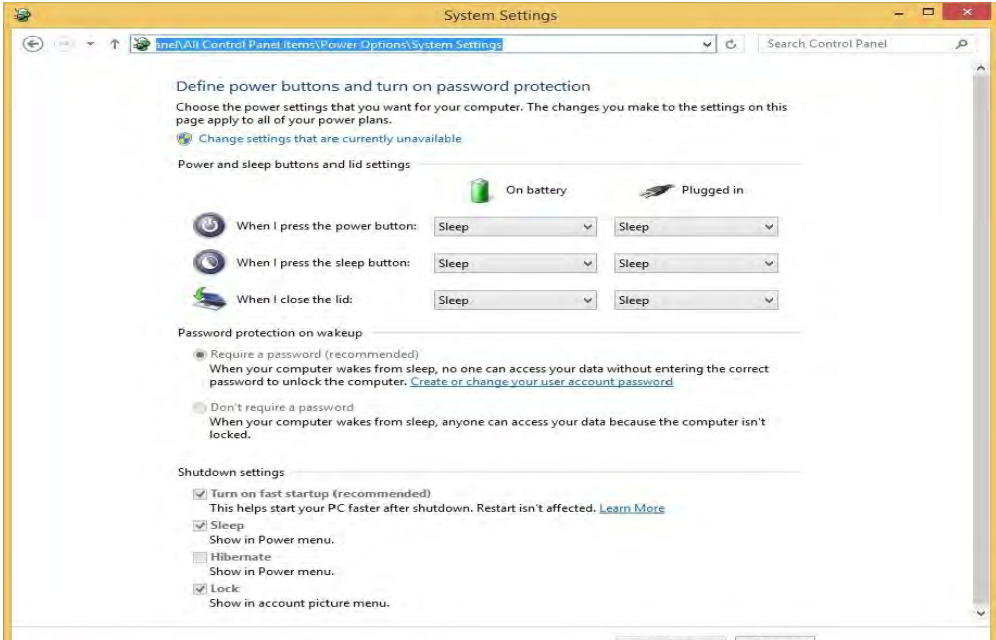



### Password Protection

It is recommended that you enable a password on wake up in order to protect your data.

However you can disable this setting from the **Power Options** menu by clicking **Require a password on wakeup** in the left menu, and selecting the options (click **Change settings that are currently unavailable**).

*Figure 3 - 5*  
**Power Options**  
**Define Power**  
**Buttons**

### Adding Hibernate/Sleep to the Power Menu

Add **Hibernate/Sleep** to the **Power Menu** as follows.

1. Go to the **Power Options (Hardware and Sound)** control panel.
2. Click **“Change settings that are currently unavailable”**  [Change settings that are currently unavailable.](#)
3. Click **Choose what the power buttons do.**
4. Click to put a check in the **Hibernate/Sleep** box under **Shutdown settings.**
5. Click **Save Changes** and close the control panel.

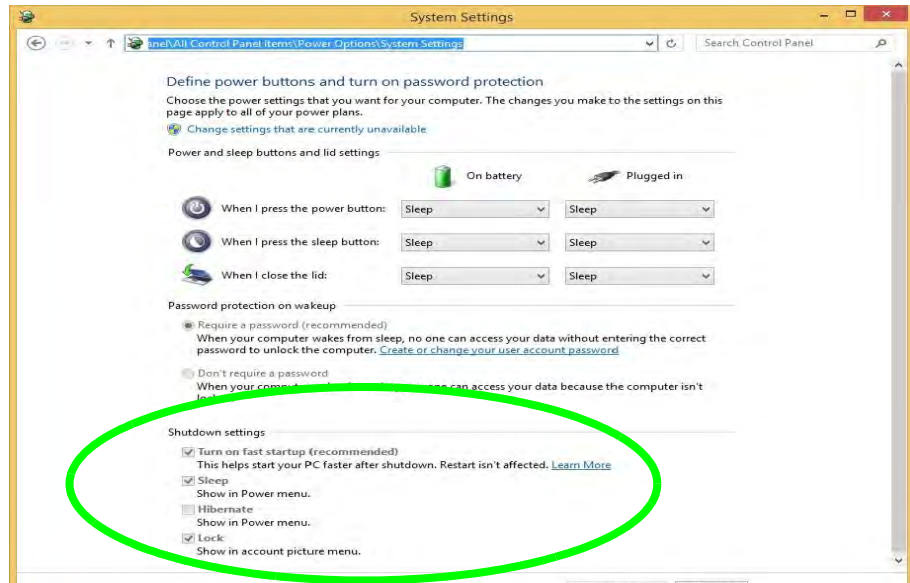

*Figure 3 - 6*  
**Power Options**  
**Define Power**  
**Buttons - Shutdown**  
**Settings**

### Resuming Operation

You can resume operation from power-saving states by pressing the power button, or in some cases pressing the sleep button (Fn + F4 key combo).



Power Status	Icon  Color	To Resume
Power Off	Off	Press the Power Button
Sleep	Blinking Green	Press the Power Button Press the Sleep Button (Fn + F4 Key Combo)
Hibernate	Off (battery) Orange (AC/DC adapter)	Press the Power Button
Display Turned Off	Green	Press a Key or Move the Mouse/Touchpad

Table 3 - 1  
Resuming  
Operation



**Power Button**

When the computer is on, you can use the power button as a Sleep/Hibernate/Shut Down hot key button when it is pressed for less than **4 seconds** (pressing and holding the power button for longer than this will force the computer to shut down).



**Closing the Lid**

If you have chosen to send the computer to **Sleep** when the lid is closed, raising the lid will wake the system up.



### Power Conservation Modes

The **Energy Star** setting will result in maximum power saving, but with the possible loss of some performance.

Setting the mode to **Balance** will give power saving matched with performance.

**Performance** will give optimum computer performance but with less power conservation.

Note that the Energy Star setting will put the display into sleep after no more than 15 minutes of user inactivity.

### Power Conservation Modes

This system supports **Energy Star** power management features that place computers (CPU, hard drive, etc.) into a low-power sleep modes after a designated period of inactivity. Adjust **Power Conservation Modes** from the **Control Center**:

1. Press the **Fn + Esc** key combination to toggle the **Control Center** on/off.
2. Click either the **Performance**, **Balanced** or **Energy Star** button.

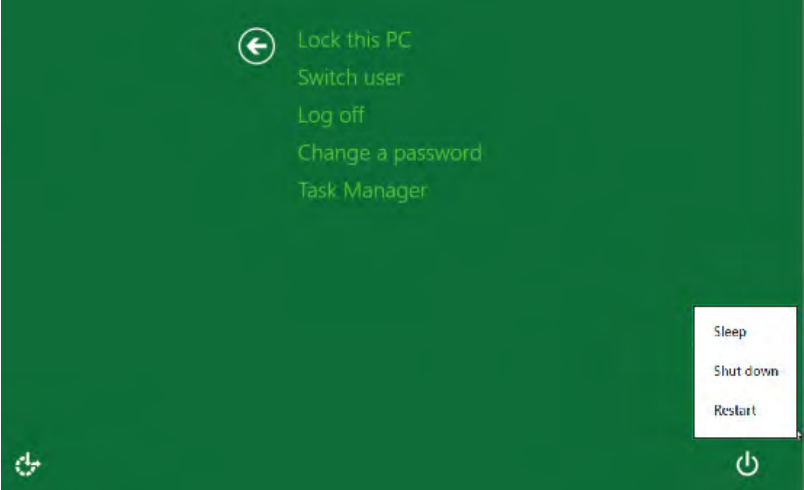

Figure 3 - 7  
Control Center



### Ctrl + Alt + Delete Key Combination

You can use the **CTRL + ALT + DEL** key combination from almost any of the *Windows 8* interfaces/Apps to bring up a full-screen displaying **Lock**, **Switch User**, **Log off**, **Change a password** and **Task Manager** options. If you click the **Power** icon in the lower right corner of the screen a power management option menu appears to display **Sleep**, **Shut down**, and **Restart**.



*Figure 3 - 8*  
**Ctrl + Alt + Delete  
Menu**

To fully control all the power options (including Hibernate mode) go to the **Power Options** control panel and configure the power button, sleep button and lid to perform the function selected.



### Low Battery Warning

When the battery is critically low, immediately connect the AC/DC adapter to the computer or save your work, otherwise, the unsaved data will be lost when the power is depleted.

*Figure 3 - 9*  
**Battery Icon (Notification Area) & Battery Advanced Settings**

## Battery Information

Follow these simple guidelines to get the best use out of your battery.

### Battery Power

Your computer's battery power is dependent upon many factors, including the programs you are running, and peripheral devices attached. You can set actions to be taken (e.g. Shut down, Hibernate etc.), and set critical and low battery levels from power plan **Change plan settings > Change advanced power settings** (see *Figure 3 - 3 on page 3 - 6*).

Click the battery icon  in the notification area to see the current battery level and charge status.

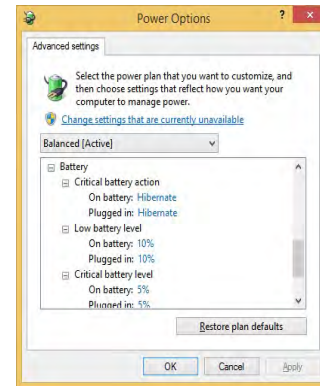

## Removing the Battery

We recommend that you do not remove the battery yourself. If you do need to remove the battery for any reason (e.g. long term storage) see below.

1. Turn the computer off, remove the AC/DC adapter and turn it over.
2. Slide the latch **1** in the direction of the arrow.
3. Slide the latch **2** in the direction of the arrow and the battery will pop up.
4. Lift the battery **3** out of the compartment.

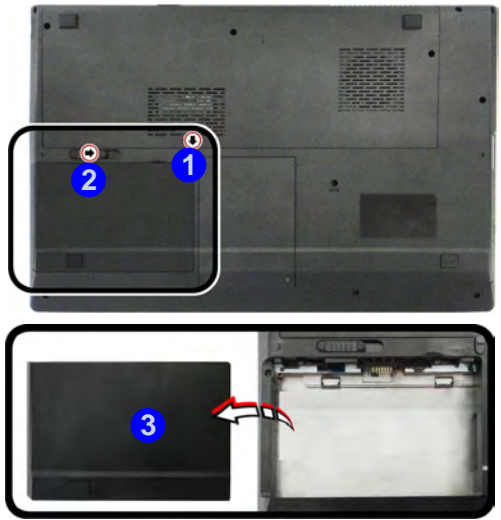

Note that though only **Model B** is pictured, the battery removal procedure is identical for both computer models.

  
**Bottom Cover Removal Warning**

Do not remove any cover(s) and /or screw(s) for the purposes of device upgrade as this may violate the terms of your warranty.

If you need to replace/remove the hard disk/RAM/optical device etc., for any reason, please contact your distributor/supplier for further information.

*Figure 3 - 10*  
**Battery Removal**



### Windows Mobility Center

The **Windows Mobility Center** control panel provides an easy point of access for information on battery status, power plans used and wireless device status etc.

## Conserving Battery Power

- Use a **power plan** that conserves power (e.g **Power saver**), however note that this may have an affect on computer performance.
- Lower the brightness level of the LCD display. The system will decrease LCD brightness slightly to save power when it is not powered by the AC/DC adapter.
- Reduce the amount of time before the display is turned off.
- Close wireless, Bluetooth, modem or communication applications when they are not being used (e.g. put the system in Airplane Mode).
- Disconnect/remove any unnecessary external devices e.g. USB devices, ExpressCards etc.

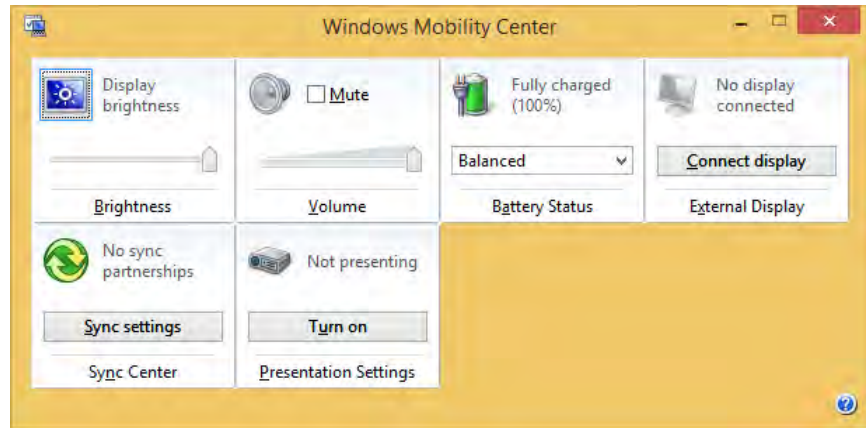

*Figure 3 - 11*  
**Windows Mobility Center**

## Battery Life

Battery life may be shortened through improper maintenance. **To optimize the life and improve its performance, fully discharge and recharge the battery at least once every 30 days.**

## New Battery

Always completely discharge, then fully charge, a new battery (see *“Battery FAQ” on page 3 - 19* for instructions on how to do this).

## Recharging the Battery with the AC/DC Adapter

The battery pack automatically recharges when the AC/DC adapter is attached and plugged into an electrical outlet. If the computer is powered on, and in use, it will take several hours to fully recharge the battery. When the computer is turned off but plugged into an electrical outlet, battery charge time is less. Refer to *“LED Indicators” on page 1 - 8* for information on the battery charge status, and to *“Battery Information” on page 3 - 14* for more information on how to maintain and properly recharge the battery pack.



### Caution

Danger of explosion if battery is incorrectly replaced.

Replace only with the same or equivalent type recommended by the manufacturer. Discard used battery according to the manufacturer's instructions.

### Proper handling of the Battery Pack

- DO NOT disassemble the battery pack under any circumstances
- DO NOT expose the battery to fire or high temperatures, it may explode
- DO NOT connect the metal terminals (+, -) to each other



### Damaged Battery Warning

Should you notice any physical defects (e.g. the battery is bent out of shape after being dropped), or any unusual smells emanating from the notebook battery, shut your computer down immediately and contact your distributor/supplier. If the battery has been dropped we do not recommend using it any further, as even if the computer continues to work with a damaged battery in place, it may cause circuit damage, which may possibly result in fire. It is recommended that you replace your computer battery every two years.

## Battery FAQ

### How do I completely discharge the battery?

Use the computer with battery power until it shuts down due to a low battery. Don't turn off the computer even if a message indicates the battery is critically low, just let the computer use up all of the battery power and shut down on its own.

1. Save and close all files and applications.
2. **Create a power plan** for discharging the battery and set all the options to **Never**.

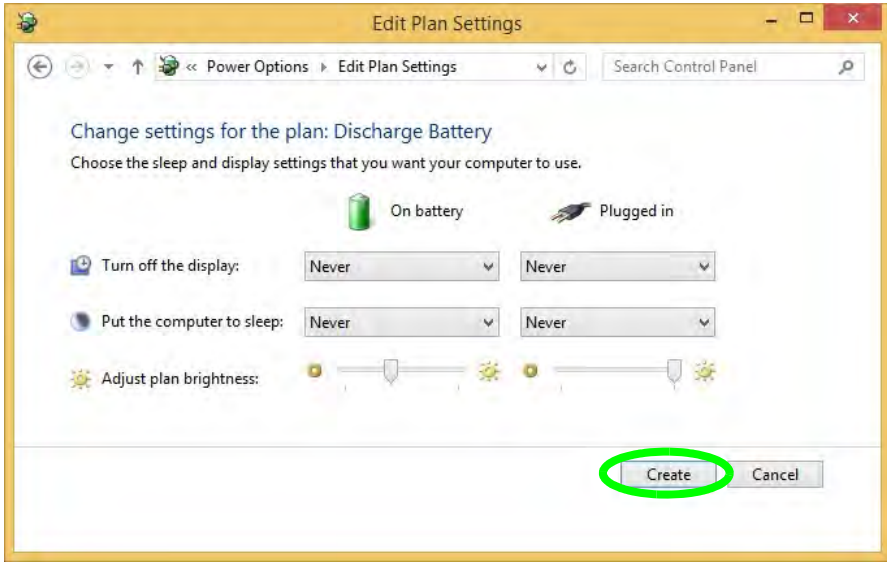
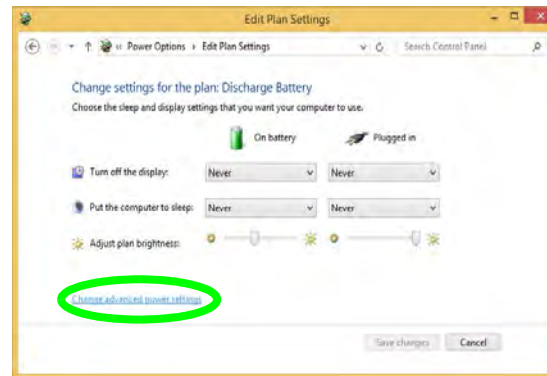
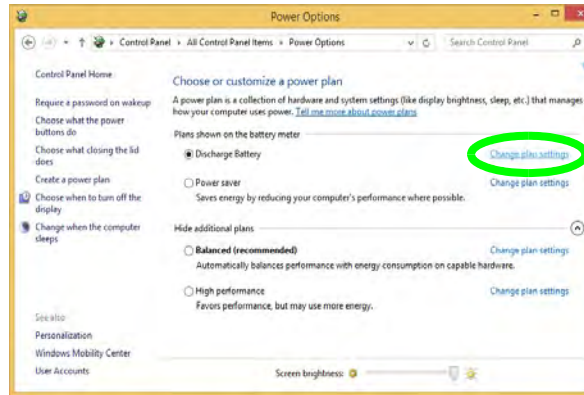

Figure 3 - 12  
Power Plan Create

## Power Management

3. Click **Change plan settings** (after creating it) and click **Change plan settings > Change advanced power settings**.

Figure 3 - 13  
Change Plan  
Settings / Change  
Advanced Power  
Settings





- 4. Scroll down to **Battery** and click **+** to expand the battery options.
- 5. Choose the options below (click **Yes** if a warning appears):

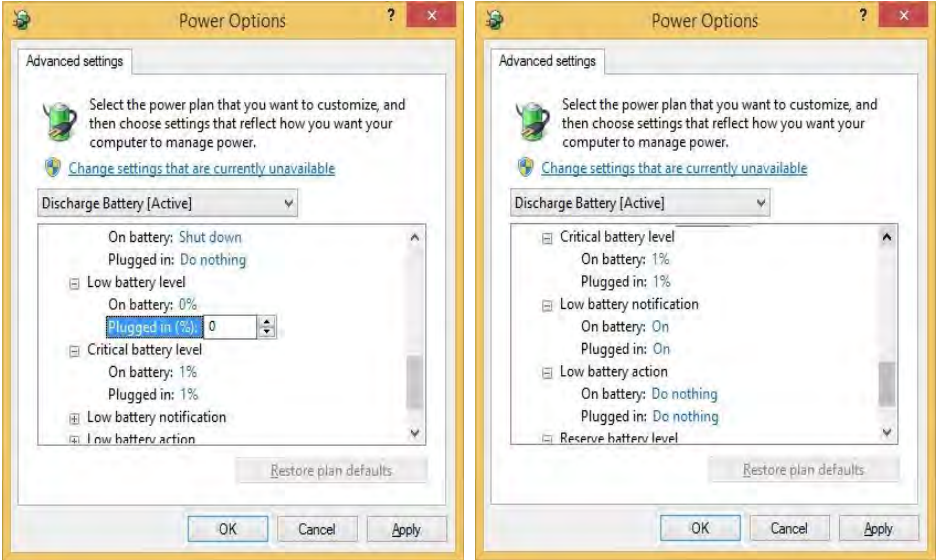

3

Figure 3 - 14  
Power Options  
Advanced Settings -  
Battery

- Low battery levels = 0%
- Critical battery Levels = 1%
- Low battery action = Do Nothing
- Critical battery action (On battery) = Shut Down
- Critical battery action (Plugged in) = Do Nothing

### **How do I fully charge the battery?**

When charging the battery, don't stop until the LED charging indicator light changes from orange to green.

### **How do I maintain the battery?**

Completely discharge and charge the battery at least once every 30 days or after about 20 partial discharges.

# Chapter 4: Drivers & Utilities

This chapter deals with installing the drivers and utilities essential to the operation or improvement of some of the computer's subsystems. The system takes advantage of some newer hardware components for which the latest versions of most available operating systems haven't built in drivers and utilities. Thus, some of the system components won't be auto-configured with an appropriate driver or utility during operating system installation. Instead, you need to manually install some system-required drivers and utilities.

## What to Install

The *Device Drivers & Utilities + User's Manual* disc contains the drivers and utilities necessary for the proper operation of the computer. *Table 4 - 1, on page 4 - 3* lists what you need to install and **it is very important that the drivers are installed in the order indicated.**

*Note that the information included on the following pages is for Windows 8.1 only.*

### Module Driver Installation

The procedures for installing drivers for the **PC Camera, WLAN and Combination Bluetooth & WLAN** modules (you should also install the **Sound Blaster Cinema, Intel Technology** drivers) are provided in *“Modules” in Chapter 6.*



### Driver Installation & Power

When installing drivers make sure your computer is powered by the AC/DC adapter connected to a working power source. Some drivers draw a significant amount of power during the installation procedure, and if the remaining battery capacity is not adequate this may cause the system to shut down and cause system problems (note that there is no safety issue involved here, and the battery will be rechargeable within 1 minute).

# Driver Installation

1. Insert the *Device Drivers & Utilities + User's Manual* disc into the computer's DVD drive.
2. Click the message "**Tap to choose what happens with this disc.**"
3. Click **Run autorun.exe**.
4. Click **Install Drivers** (button), or **Option Drivers** (button) to access the **Optional** driver menu.

5. Check the driver installation order from [Table 4 - 1, on page 4 - 3](#) (the drivers must be installed in this order) which is the same as that listed in the *Drivers Installer* menu below.
6. Click to select the driver you wish to install, (you should note down the drivers as you install them).
7. Follow the instructions for each individual driver installation procedure as listed on the following pages.



Figure 4 - 1 - Drivers Installer Screen 1



Figure 4 - 2 - Install Drivers

Win 8.1 Driver	Page #	Win 8.1 - Optional Items	Page #
<i>Chipset</i>	<i>Page 4 - 6</i>	<i>Setting Up SATA RAID or AHCI Mode</i>	<i>Page 6 - 2</i>
<i>Video (VGA)</i>	<i>Page 4 - 6</i>	<i>PC Camera Module</i> (No driver required)	<i>Page 6 - 12</i>
<i>NVIDIA Video (VGA)</i>	<i>Page 4 - 6</i>	<i>Wireless LAN Module</i>	<i>Page 6 - 21</i>
<i>LAN</i>	<i>Page 4 - 6</i>	<i>Fingerprint Reader Module</i> (Model A/C Computers Only)	<i>Page 6 - 27</i>
<i>Card Reader</i>	<i>Page 4 - 6</i>	<i>Trusted Platform Module</i>	<i>Page 6 - 31</i>
<i>Touchpad</i>	<i>Page 4 - 6</i>	<i>Bluetooth &amp; WLAN Combo Module</i>	<i>Page 6 - 45</i>
<i>Hot Key</i>	<i>Page 4 - 7</i>	<i>Intel® Rapid Storage Technology</i> (required for hard disks in AHCI mode)	<i>Page 6 - 50</i>
<i>Airplane</i>	<i>Page 4 - 7</i>	<i>Intel® Rapid Start Technology Driver</i>	<i>Page 6 - 59</i>
<i>MEI Driver</i>	<i>Page 4 - 7</i>	<i>Sound Blaster Cinema EQ</i>	<i>Page 6 - 67</i>
<i>Audio</i>	<i>Page 4 - 7</i>	<i>Wireless Display</i> (No driver required)	<i>Page 6 - 72</i>
		<i>3G Module</i> (Model A/C Computers Only - No driver required)	<i>Page 6 - 76</i>

*Table 4 - 1 - Driver Installation*

*All drivers provided are for the Windows 8.1 operating system.*

*Note that you need to install both the WLAN & Bluetooth drivers for the WLAN & Bluetooth Combo modules.*

### Manual Driver Installation

Click **Browse CD/DVD** (button) in the *Drivers Installer* application and browse to the executable file in the appropriate driver folder.

## 4

### Windows Update

After installing all the drivers make sure you enable **Windows Update** in order to get all the latest security updates etc. (all updates will include the latest **hotfixes** from Microsoft). See [“Windows Update” on page 4 - 8](#) for instructions.

### Updating/Reinstalling Individual Drivers

If you wish to update/reinstall individual drivers it may be necessary to uninstall the original driver. To do this go to the **Control Panel** in the *Windows OS* and double-click the **Programs and Features** icon (**Programs > Uninstall a program**). Click to select the driver (if it is not listed see below) and click **Uninstall**, and then follow the on screen prompts (it may be necessary to restart the computer). Reinstall the driver as outlined in this chapter.

If the driver is not listed in the **Programs and Features** menu:

1. Go to the **Control Panel**).
2. Double-click **Device Manager (Hardware and Sound > Devices and Printers > Device Manager)**.
3. Double-click the **device** you wish to update/reinstall the driver for (you may need to click “+” to expand the selection).
4. Click **Driver** (tab) and click the **Update Driver** or **Uninstall** button and follow the on screen prompts.

## User Account Control

If a **User Account Control** prompt appears as part of the driver installation procedure, click **Continue** or **Allow**, and follow the installation procedure as directed.

## Windows Security Message

If you receive a *Windows* security message as part of the driver installation process. Just click “*Install this driver software anyway*” or “*Install*” to continue the installation procedure.

You will receive this message in cases where the driver has been released after the version of *Windows* you are currently using. All the drivers provided will have already received certification for *Windows*.

## New Hardware Found

If you see the message “**New Hardware Found**” during the installation procedure (**other than when outlined in the driver install procedure**), click **Cancel** to close the window, and follow the installation procedure.



### Driver Installation General Guidelines

The driver installation procedure outlined in this Chapter (and in **Chapter 7 Options & Modules**), are accurate at the time of going to press.

Drivers are always subject to upgrade and revision so the exact procedure for certain drivers may differ slightly. As a general guide follow the default on screen instructions for each driver (e.g. **Next > Next > Finish**) unless you are an advanced user. In many cases a restart is required to install the driver.

Make sure any modules (e.g. WLAN or Bluetooth) are **ON (i.e. the system is not in Airplane Mode)** before installing the appropriate driver.

### Driver Installation Procedure

Insert the *Device Drivers & Utilities + User's Manual* disc and click **Install Drivers** (button), or **Option Drivers** (button) to access the **Optional** driver menu.

4

#### Chipset

1. Click **1.Install Chipset Driver > Yes**.
2. Click **Next > Yes > Next > Next**.
3. Click **Finish** to restart the computer.

#### Video (VGA)

1. Click **2.Install VGA Driver > Yes**.
2. Click **Next > Yes > Next > Next**.
3. Click **Finish** to restart the computer.

#### NVIDIA Video (VGA)

1. Click **3.Install NVIDIA VGA Driver > Yes**.
2. Click **AGREE AND CONTINUE** (button) to accept the terms of the license agreement.
3. Click **Next**.
4. Click **Close** to complete the installation.

**Note:** After installing the video driver go to the **Display/Display Settings** control panel to adjust the video settings to the highest resolution.

#### LAN

1. Click **4.Install LAN Driver > Yes**.
2. Click **Next > Install**.
3. Click **Finish**.

#### Card Reader

1. Click **5.Install Cardreader Driver > Yes**.
2. Click **Finish**.

#### Touchpad

1. Click **6.Install Touchpad Driver > Yes**.
2. Click **Next**.
3. Click the button to accept the license, and then click **Next**.
4. Click **Finish > Restart Now** to restart the computer.



## Hot Key

1. Click **7.Install Hotkey AP > Yes.**
2. Click **Next > Next.**
3. Click **Finish > Finish** to restart your computer.

## Airplane

*Note: Do not use Update Driver in Device Manager to install the Airplane Mode driver.*

1. Click **8.Install AirplaneMode AP > Yes.**
2. Click **Next.**
3. Click **Finish** to restart the computer.

## MEI Driver

1. Click **9.Install MEI Driver > Yes.**
2. Click **Next > Yes > Next.**
3. Click **Finish.**

## Audio

1. Click **10.Install Audio Driver > Yes.**
2. Click **Next.**
3. Click **Install > Finish.**
4. Click **Finish** to restart the computer.

After installing the audio driver the system will not return to the **Drivers Installer** screen. To install any of the optional drivers, eject the *Device Drivers & Utilities + User's Manual* disc and then reinsert it (or double-click the disc icon in My Computer), and click **Option Drivers** (button) to access the optional driver menu.

It is recommended that you install the **Sound Blaster Audio** application for maximum audio performance (see "[Sound Blaster Cinema EQ](#)" on page 6 - 67) and **Intel Rapid Storage Technology** driver (see "[Intel® Rapid Storage Technology](#)" on page 6 - 50 - required for AHCI or RAID mode).



### Windows Update

After installing all the drivers make sure you enable **Windows Update** in order to get all the latest security updates etc. (all updates will include the latest **hotfixes** from Microsoft).

To enable **Windows Update** make sure you are **connected to the internet**:

1. Go to the **Control Panel**.
2. Click **Windows Update** (System and Security/ Security).
3. Click **Check for updates** (button).
4. The computer will now check for updates (you need to be connected to the internet).
5. Click **Install now** (button) to begin checking for the updates.
6. Click **Install updates** (button) to install the updates.

## Optional Drivers

See the pages indicated in *Table 4 - 1, on page 4 - 3* for the driver installation procedures for any modules included in your purchase option.

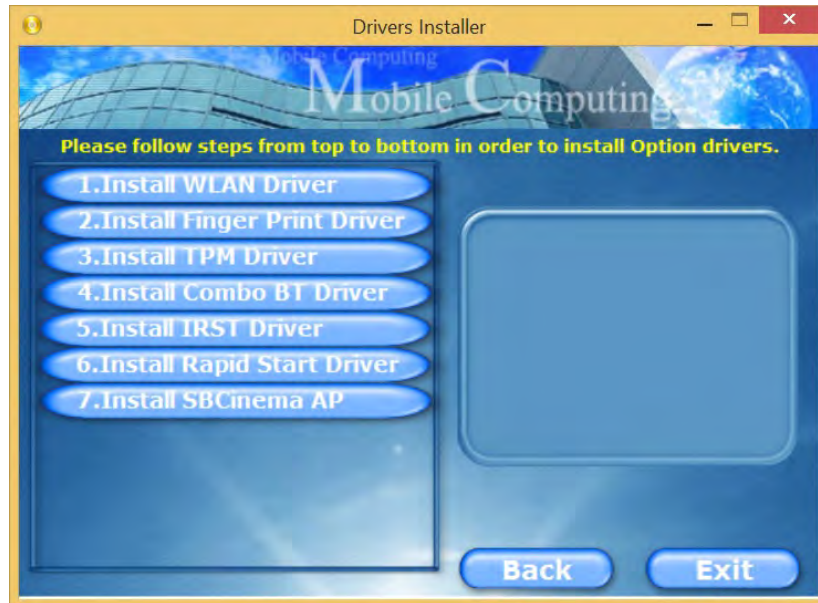

*Figure 4 - 3 - Optional Drivers Installer Screen*

*Note that you need to install both the WLAN & Bluetooth drivers for all the Bluetooth Combo modules.*



# Chapter 5: BIOS Utilities

## Overview

This chapter gives a brief introduction to the computer's built-in software:

**Diagnostics:** The **POST** (Power-On Self Test)

**Configuration:** The *Setup* utility

If your computer has never been set up, or you are making important changes to the system (e.g. hard disk setup), then you should review this chapter first and note the original settings found in *Setup*. Even if you are a beginner, keep a record of the settings you find and any changes you make. This information could be useful if your system ever needs servicing.

There is one general rule: *Don't make any changes unless you are sure of what you are doing*. Many of the settings are required by the system, and changing them could cause it to become unstable or worse. If you have any doubts, consult your service representative.



### BIOS Screens

Note that the BIOS screens pictured on these pages are intended for guidance in setting up your system's BIOS.

BIOS versions are subject to constant change and revision, therefore your computer's actual screens may appear slightly different from those pictured on these pages.

## The Power-On Self Test (POST)

If you enable the **Boot-time Diagnostic Screen** in the Setup Utility, each time you turn on the computer the system takes a few seconds to conduct a **POST**, including a quick test of the on-board RAM (memory).

As the **POST** proceeds, the computer will tell you if there is anything wrong. If there is a problem that prevents the system from booting, it will display a system summary and prompt you to run *Setup*.

If there are no problems, the *Setup* prompt will disappear and the system will load the operating system. Once that starts, you can't get into *Setup* without rebooting.

## Failing the POST

Errors can be detected during the **POST**. There are two categories, “fatal” and “non-fatal”.

### Fatal Errors

These stop the boot process and usually indicate there is something seriously wrong with your system. Take the computer to your service representative or authorized distributor/supplier as soon as possible.

### Non-Fatal Errors

This kind of error still allows you to boot. You will get a message identifying the problem (make a note of this message!) and you can then press **F7** (the **F7** on screen will be highlighted to illustrate that the system is processing the request) for boot options.

Press **F2** (give the system a few seconds to enter *Setup*; the **F2** on screen will be highlighted to illustrate that the system is processing the request) to run the **Setup** program and try to correct the problem. If you still get an error message after you change the setting, or if the “cure” seems even worse, call for help.



### BIOS Settings Warning

Incorrect settings can cause your system to malfunction. To correct mistakes, return to *Setup* and restore the *Previous Values* with <F2>, or *Optimized Defaults* with <F3>.

## The Setup Utility

The **Aptio Setup Utility** tells the system how to configure itself and manage basic features and subsystems (e.g. port configuration).

### Entering Setup

To enter *Setup*, turn on the computer and press **F2** (give the system a few seconds to enter *Setup*; the **F2** on screen will be highlighted to illustrate that the system is processing the request) during the **POST** (or press **F7** for boot options). If you get a “Keyboard Error”, (usually because you pressed **F2** too quickly) just press **F2** again.

If the computer is already on, reboot using the **Ctrl + Alt + Delete** combination and then hold down **F2** when prompted. The *Setup* main menu will appear.

To see the boot options press **F7**.



## Setup Screens

The following pages contain additional advice on portions of the *Setup*. Along the top of the screen is a menu bar with menu headings. When you select a heading, a new screen appears. Scroll through the features listed on each screen to make changes to *Setup*.

Instructions on how to navigate each screen are in the box at the bottom right side of the screen.

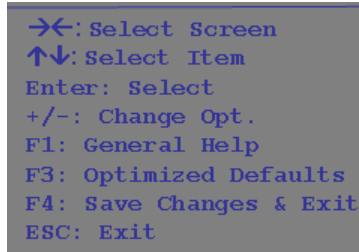

```
→←: Select Screen
↑↓: Select Item
Enter: Select
+/-: Change Opt.
F1: General Help
F3: Optimized Defaults
F4: Save Changes & Exit
ESC: Exit
```

If these tools are confusing, press **F1** to call up a **General Help** screen, and then use the arrow keys to scroll up or down the page.

The **Item Specific Help** on the upper right side of each screen explains the highlighted item and has useful messages about its options.

If you see an arrow ► next to an item, press **Enter** to go to a sub-menu on that subject. The sub-menu screen that appears has a similar layout, but the **Enter** key may execute a command.



### Setup Menus

The **Setup** menus shown in this section are for **reference** only. Your computer's menus will indicate the configuration appropriate for your model and options.

*Figure 5 - 1*  
Navigation Menu

# Main Menu

Figure 5 - 2  
Main Menu

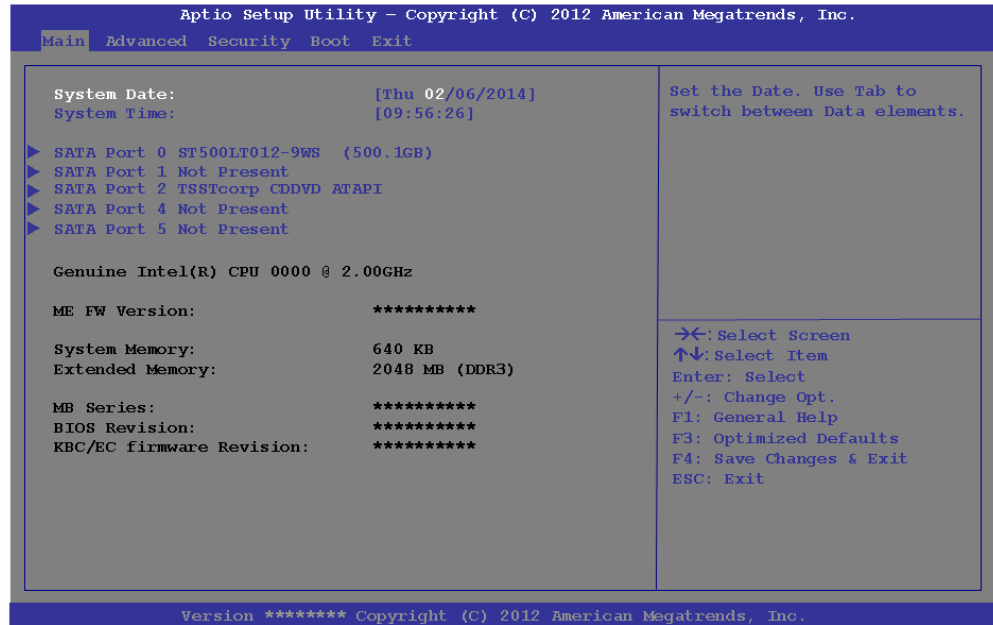

## System Time & Date (Main Menu)

The hour setting uses the 24-hour system (i.e., 00 = midnight; 13 = 1 pm). If you can change the date and time settings in your operating system, you will also change these settings. Some applications may also alter data files to reflect these changes.

### *SATA Port # (Main Menu)*

Pressing **Enter** opens the sub-menu to show the configuration of a optical Device/ HDD on the computer's SATA Ports.

### *System/Extended Memory (Main Menu)*

This item contains information on the system memory, and is not user configurable. The system will auto detect the amount of memory installed.

### *MB Series / BIOS Revision / KBC/EC Firmware Revision (Main Menu)*

This item contains information on the BIOS version and video card etc., and is not user configurable.

## Advanced Menu

Figure 5 - 3  
Advanced Menu



*Advanced Chipset Control (Advanced Menu)*

The sub-menu here allows you to change **mSATA/3G Slot Support**.

*mSATA/3G Slot Support*

*(Advanced Menu > Advanced Chipset Control)*

Select which device is installed in the mSATA/3G slot from this menu option. Select the appropriate device installed in the slot from the menu, and then save the changed BIOS settings. You will then need to **shutdown the system and remove the AC/DC adapter**. You should then plug the AC/DC adapter back in again and restart the computer to have the system recognize the changes made.

**m/SATA/3G Slot Support**

Note that 3G device will only be available as a selectable option if you have included it in your purchase configuration.

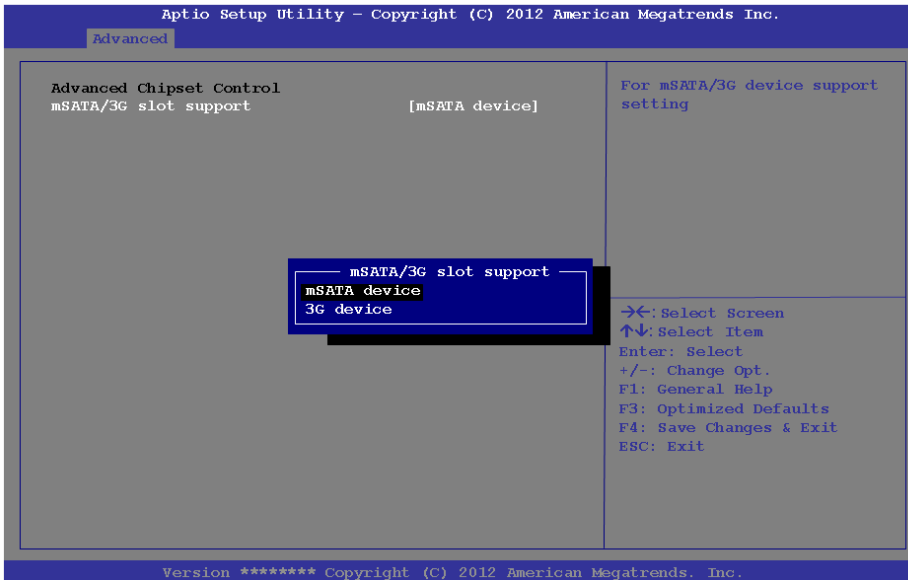

*Figure 5 - 4*  
**Advanced Chipset Control (Advanced Menu)**



### SATA Mode Selection

If you have installed the Windows operating system with either AHCI or RAID mode enabled, **DO NOT** disable the set mode (if you wish to disable the set mode you will need to reinstall the Windows OS).

#### *Intel(R) Rapid Start Technology (Advanced Menu)*

Enable/disable **Intel(R) Rapid Start Technology** from this menu. The rapid start hibernation mode can resume power within 5 to 6 seconds and can remember your computer's state with zero power.

#### *SATA Mode (Advanced Menu)*

You can configure SATA (Serial ATA) control to operate in **AHCI** (Advanced Host Controller Interface) or **RAID** (Redundant Array of Independent disks) modes from this menu. The **SATA Mode** should be set **BEFORE installing an operating system**, and after you have backed up all necessary files and data (see sidebar). See *“Setting Up SATA RAID or AHCI Mode” on page 6 - 2* for details.

Make sure you install the **Intel Rapid Storage Technology application** after setting the SATA Mode to **RAID** or **AHCI** (see *“Intel® Rapid Storage Technology” on page 6 - 50*).

#### *Boot Logo (Advanced Menu)*

Use this menu item to enable/disable the **Boot Logo** screen at system startup **if you have not enabled UEFI Boot**. If you disable the **Boot Logo** you will not see the **F2 Enter Setup** or **F7 Boot Options** prompts on the screen, however you can still press these keys, while the boot screen is displayed, to perform the Enter Setup or Boot Option functions.

When **UEFI Boot is enabled**, then the prompts to press **F2 or F7** will not appear. However you can still press **F2** to enter the setup, or **F7** to choose the preferred boot device, if you press the key immediately the system boots up.

*Power On Boot Beep (Advanced Menu)*

Use this menu item to enable/disable the beep as the computer starts up.

*Battery Low Alarm Beep (Advanced Menu)*

Use this menu item to enable/disable the battery low alarm beep.

# Security Menu



## Security Menu

The changes you make here affect the access to the **Setup** utility itself, and also access to your machine as it boots up after you turn it on. These settings do not affect your machine or network passwords which will be set in your software OS.

5

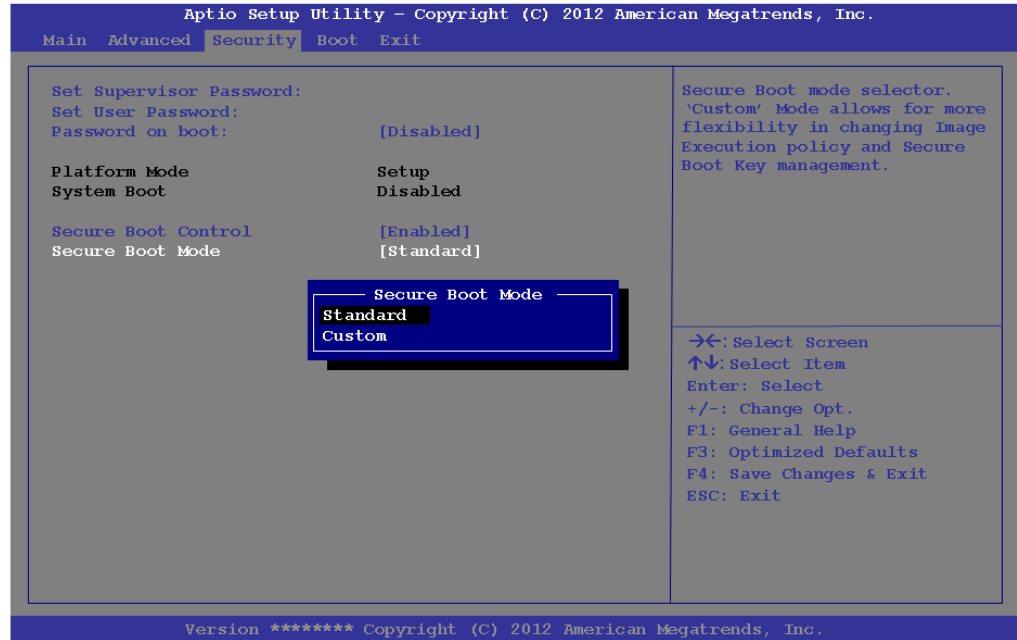

Figure 5 - 5 Security Menu

### Set Supervisor Password (Security Menu)

You can set a password for access to the **Aptio Setup Utility**. This will not affect access to the computer OS (only the **Aptio Setup Utility**).



**Note:** To clear existing passwords press **Enter** and type the existing password, then press **Enter** for the new password (without typing any password entry) and **Enter** again to confirm the password clearance.

**Note:** *You can only set the user password after you have set the supervisor password.*

#### *Password on boot: (Security Menu)*

Specify whether or not a password should be entered to boot the computer (**you may only set a password on boot if a supervisor password is enabled**). If “*Enabled*” is selected, only users who enter a correct password can boot the system (**see the warning in the sidebar**). The default setting is “*Disabled*”.

#### *Secure Boot (Security Menu)*

Secure Boot prevents unauthorized operating systems and software from loading during the startup process. **Secure Boot** is available as a menu option if you have **Windows 8** set as your operating system, and have **enabled UEFI Boot** (see “*Boot Menu*” on page 5 - 14). Enabling Secure Boot will bring up the **Secure Boot Mode** menu to enable you to configure Secure Boot as **Standard** (with a fixed secure boot policy), or **Custom** (which enables you to make changes to the **Image Execution Policy** and **Key Management** database).



#### Password Warning

If you set a boot password (Password on boot is “Enabled”), **NEVER** forget your password.

The consequences of this could be serious. If you cannot remember your boot password you must contact your vendor and you may lose all of the information on your hard disk.

## Boot Menu

Figure 5 - 6  
Boot Menu

5



### BIOS Screens

Note that the BIOS screens pictured on these pages are intended for guidance in setting up your system's BIOS.

BIOS versions are subject to constant change and revision, therefore your computer's actual screens may appear slightly different from those pictured on these pages.

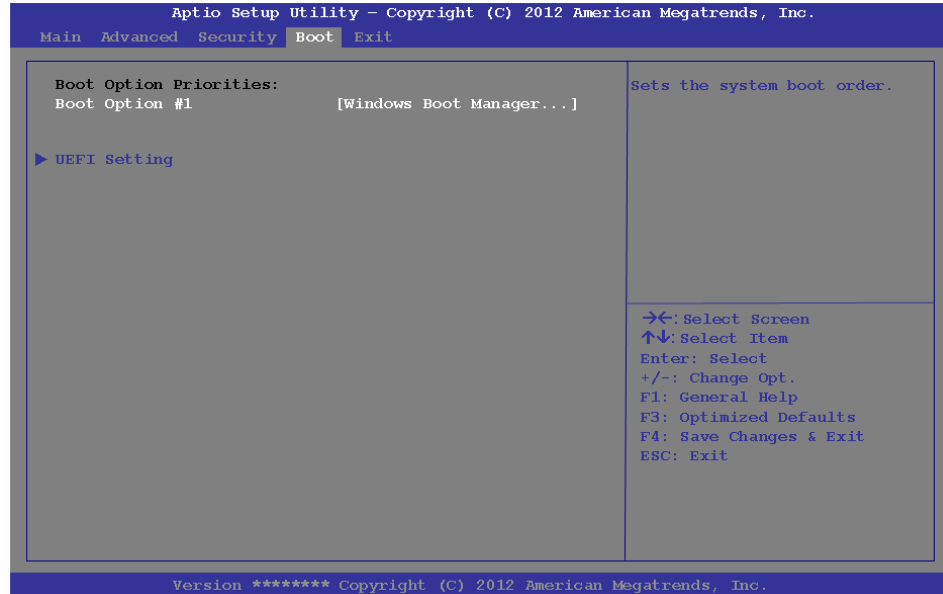

When you turn the computer on it will look for an operating system (e.g. *Windows 7*) from the devices listed in this menu, and **in this priority order**. If it cannot find the operating system on that device, it will try to load it from the next device in the order specified in the **Boot Option Priorities**. Item specific help on the right is available to help you move devices up and down the order.

### *Boot Option Priorities (Boot Menu)*

Use the arrow keys to move up and down the menu, and press enter to select a device from the menu (the selected device will be highlighted in white).

### *UEFI Boot (Boot Menu > OS Select)*

Enable/disable UEFI Boot from this menu. The Unified Extensible Firmware Interface (UEFI) specification provides a clean interface between operating systems and platform firmware at boot time. In contrast to BIOS, UEFI defines a set of standard boot and runtime services. The **Network Stack** item will be enabled as an option under UEFI Boot.

## Exit Menu

Figure 5 - 7  
Exit Menu

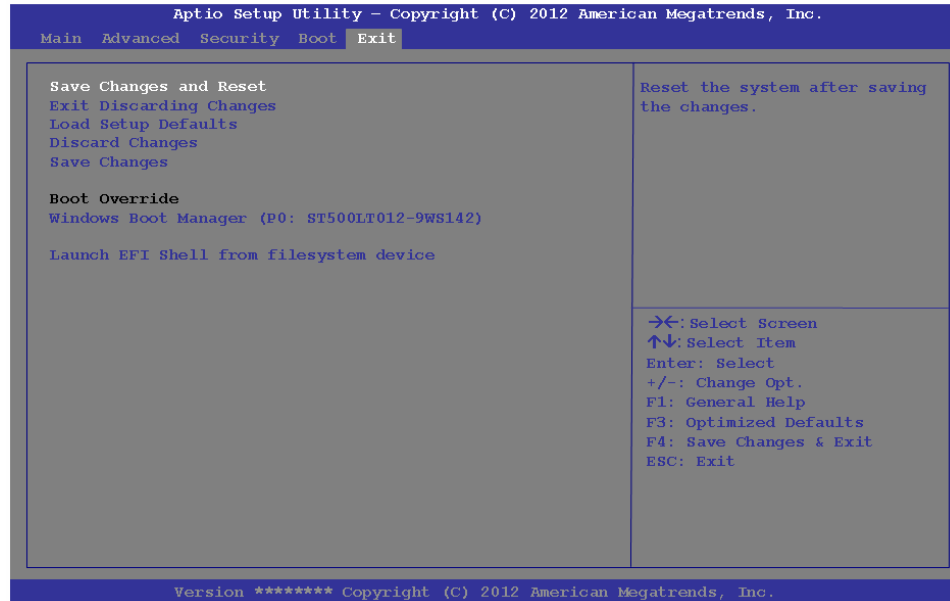

Click *Save Changes and Reset* to save all changes made. Choosing to *Discard Changes*, or *Exit Discarding Changes*, will wipe out any changes you have made to the *Setup*. You can also choose to restore the original *Setup* defaults that will return the *Setup* to its original state, and erase any previous changes you have made in a previous session.

# Chapter 6: Modules

## Overview

This chapter contains the information on the various modules (some of which are **optional**) which may come with your computer, depending on the configuration purchased. If you are unsure please contact your service representative.

The chapter includes information on the following:

- Setting Up SATA RAID or AHCI Mode
- PC Camera Module
- Wireless LAN Module
- Fingerprint Reader Module
- Trusted Platform Module
- Bluetooth & WLAN Combo Module
- Intel® Rapid Storage Technology
- Intel® Rapid Start Technology Driver
- Sound Blaster Cinema EQ
- Wireless Display
- 3G Module



### RAID Hard Disks

All hard disks/SSDs in a RAID should be identical (the same size and brand) in order to prevent unexpected system behavior.

### SATA Mode Selection

The SATA mode selection should be made **before installing your operating system**.

**DO NOT change your selected SATA mode** unless you intend to re-install your operating system. Make sure you have backed up all your data before doing so.

## Setting Up SATA RAID or AHCI Mode

### AHCI Mode

Advanced Host Controller Interface (AHCI) is an interface specification that allows the storage driver to enable advanced serial ATA features such as Native Command Queuing (for maximum hard disk efficiency and performance). AHCI mode can be supported by one or two hard disks. Make sure you install the **Intel® Rapid Storage Technology** application if you have set up your hard disk(s)/SSDs in AHCI mode (see “*Intel® Rapid Storage Technology*” on page 6 - 50)

### RAID

To configure your RAID (Redundant Array of Independent Disks) system in Striping (RAID 0), Mirroring (RAID 1) or Recovery modes (see *Table 6 - 1, on page 6 - 3*) you will require **at least two identical** (see sidebar) hard disks/SSDs. Note that you will need to install a driver from the *Device Drivers & Utilities + User's Manual disc* at OS installation (see page 6 - 4).

### Intel® Rapid Storage Technology Application

Make sure you install the **Intel® Rapid Storage Technology** application if you have set up your hard disk(s) in RAID mode (see “*Intel® Rapid Storage Technology*” on page 6 - 50).

RAID Level	Description
RAID 0	Identical drives reading and writing data in parallel to <b>increase performance</b> . RAID 0 implements a striped disk array and the data is broken into blocks and each block is written to a separate disk drive.
RAID 1	Identical drives in a mirrored configuration used to <b>protect data</b> . Should a drive that is part of a mirrored array fail, the mirrored drive (which contains identical data) will handle all the data. When a new replacement drive is installed, data to the new drive is rebuilt from the mirrored drive to restore fault tolerance.
Recovery	Two identical drives copying data between a master and a recovery disk. This provides more control over how data is copied between the master and recovery drives, fast volume updates and the ability to view the data in <i>Windows Explorer</i> .

Table 6 - 1  
RAID Levels



### Array Types

A **Mirrored Array (RAID 1)** provides full data protection, as data can simply be copied from a healthy disk to a replacement for any failed disk.

A **Striped Array (RAID 0)** is **NOT** fault-tolerant. The failure of one drive will result in the loss of all data in the array. It is designed to increase disk performance by spreading the I/O load across the channels and drives.



### SATA Mode Selection

The SATA mode selection should be made **before installing your operating system**.

**DO NOT change your selected SATA mode** unless you intend to reinstall your operating system. Make sure you have backed up all your data before doing so.

### RAID Hard Disks/SSDs

All hard disks/SSDs in a RAID should be identical (the same size and brand) in order to prevent unexpected system behavior.



### RAID Hard Disks

All hard disks/SSDs in a RAID should be identical (the same size and brand) in order to prevent unexpected system behavior.

### SATA Mode Selection

The SATA mode selection should be made **before installing your operating system**.

**DO NOT change your selected SATA mode** unless you intend to re-install your operating system. Make sure you have backed up all your data before doing so.

## SATA RAID Setup Procedure (Windows 8.1)

To configure your RAID (Redundant Array of Independent Disks) system in Striping (RAID 0) or Mirroring (RAID 1) modes (see *Table 6 - 1, on page 6 - 3*) you will require **at least two identical** (see sidebar) hard disks or **mSATA solid state drives (SSDs) installed**.

You need to setup a RAID before installing your *Windows 8.1* operating system, and you will need to prepare the following in order to do so.

1. The *Microsoft Windows 8.1 OS DVD*.
2. A hard disk or SSD installed.
3. A **second** (identical) hard disk installed or SSD installed.
4. The *Device Drivers & Utilities + User's Manual disc*.
5. A USB flash drive.
6. An operable computer (to copy files from the *Device Drivers & Utilities + User's Manual* disc to the USB flash drive).

Before setting up the system you will need to copy a driver folder to a USB flash drive or external USB hard disk. This driver folder is included on the *Device Drivers & Utilities + User's Manual disc* but you will need to go to an operable computer and copy the folder to a USB Flash drive or external USB hard disk.



1. Go to the operable computer and insert a USB Flash drive or external USB hard disk.
2. Insert the **Device Drivers & Utilities + User's Manual** disc into the CD/DVD drive of the operable computer.
3. Copy the **f6flpy-x86** or **f6flpy-x64** folder from the location below (D: denotes your DVD drive) on the **Device Drivers & Utilities + User's Manual** disc to the USB flash drive or external USB hard disk.

- **For Windows 8.1 64-bit = D:\Options\RAID\f6flpy-x64**

4. Start-up your notebook computer and press <F2> to enter the **BIOS**.
5. Go to the **Advanced** menu.
6. Select **SATA Mode** (see page **5 - 10**), press <Enter> and select "**RAID Mode**".
7. Press <F4> and <Yes> to "**Save Changes and Reset**".
8. After computer restarts press <F2> to enter the **BIOS** again.
9. Go to **Intel(R) Rapid Storage Technology** (in the **Advanced** menu) and press <Enter>.
10. Select **Create RAID Volume** and press <Enter>.

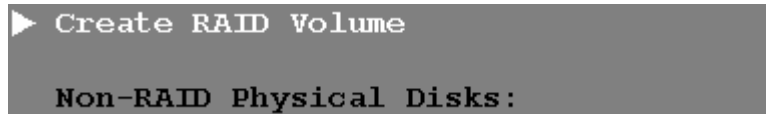

*Figure 6 - 1*  
**Create RAID Volume**  
**(Advanced > Intel(R)**  
**Rapid Storage**  
**Technology**

## Modules

11. You can now setup your RAID volume using any two installed disks.
12. Go to **Name:** and press <Enter>.
13. Type a name of your choice for your RAID volume and press <Enter>.

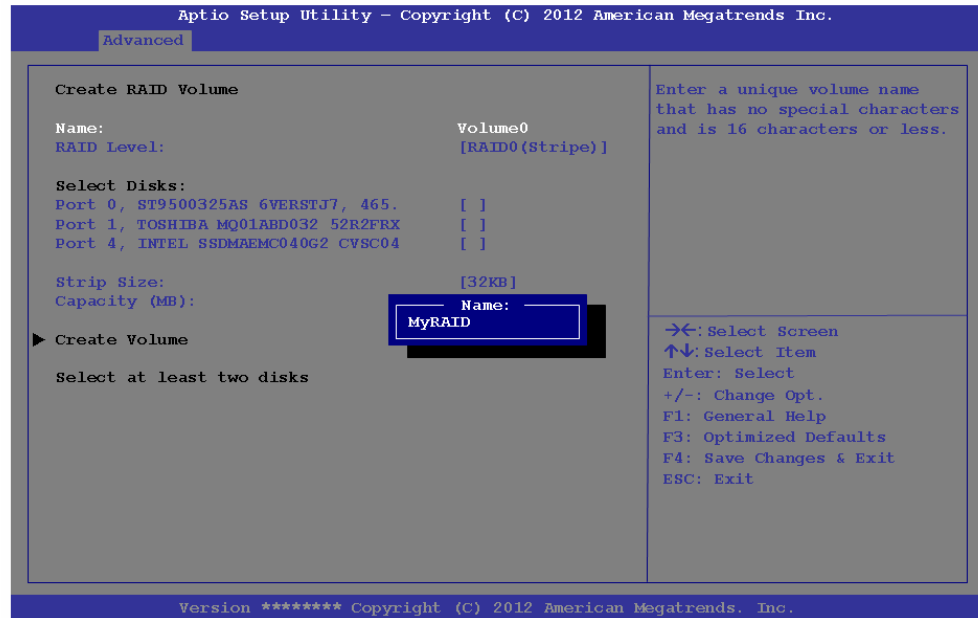

6

*Figure 6 - 2*  
**Name the RAID Volume (Advanced > Intel(R) Rapid Storage Technology)**

14. Go to **RAID Level:** and press <Enter>.
  15. Choose the RAID Level required (see *Table 6 - 1, on page 6 - 3* for details) and press <Enter>.
    - **RAID0 (Stripe)**
    - **RAID1 (Mirror)**
    - **Recovery**
  16. Go to any of the disks listed under **Select Disks:** and select a disk name and press <Enter>.
  17. Move the cursor down (use the arrow keys) onto to **X** (o select the disk required and press <Enter>.
- If you have selected a **Recovery** level RAID then you need to select one disk to be **Master disk (M)** and one disk to be the **Recovery disk (R)**



*Figure 6 - 3*  
**Select Disks**  
 (Advanced > Intel(R)  
 Rapid Storage  
 Technology)

18. You should select two identical disks to form your RAID volume.
19. If you have selected **RAID0 (Stripe)** then you can adjust the “**Strip Size**” to your requirements.
20. If you have selected **Recovery** then you can adjust the **Synchronization** to “**On Request**” or “**Continuous**”.
21. Go to **Create Volume** and press <Enter>.
22. The RAID volume will then be created and the RAID information will be displayed under **Intel(R) Rapid Storage Technology** (in the **Advanced** menu).

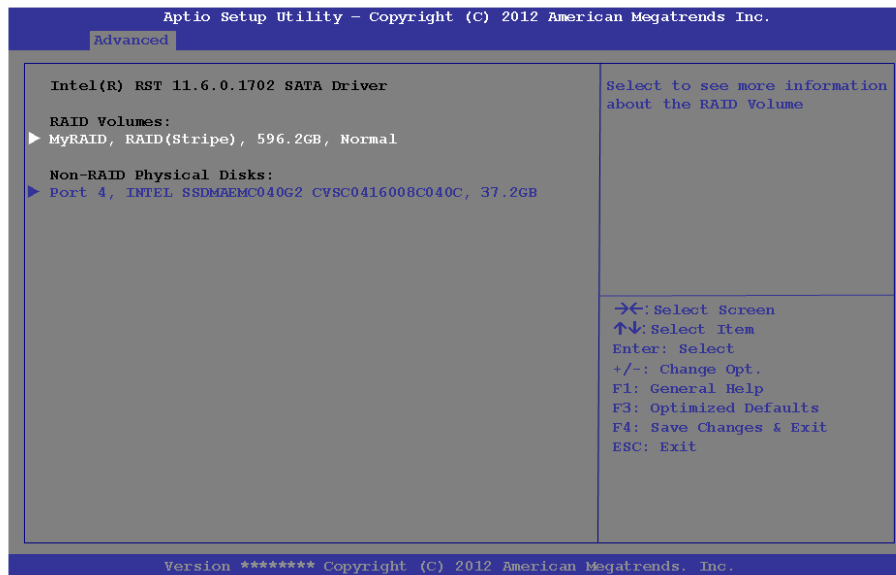

*Figure 6 - 4*  
**Created RAID Information (Advanced > Intel(R) Rapid Storage Technology)**

23. Press <Esc> to exit the menu.
24. Press <F4> and <Yes> to “**Save Changes and Reset**”, however **ensure that the two conditions in the bulleted points below are met** before doing so.
  - Make sure the *Windows 8.1* OS DVD is in the DVD drive. and as the computer starts up it will automatically boot from the *Windows 8.1* OS DVD (you will be prompted to press a key to boot from the DVD).
  - Make sure your USB Flash drive or external USB hard disk is attached to one of the USB ports on the computer.
25. Press <F7> as the computer starts up to bring up the boot device menu.
26. Select the DVD drive containing the *Windows 8.1* OS DVD and press <Enter>.
27. Press a key at system startup to begin installing *Windows* from your *Microsoft Windows 8.1* disc.
28. Click **Next > Install Now** to continue installing the operating system as normal (see your *Windows* documentation if you need help on installing the *Windows* OS).
29. A prompt will appear to ask you to **Load Driver**.
30. Click **Browse** and browse to the location you copied the files to on your USB Flash drive or external USB hard disk (X: denotes your USB Flash drive or external USB hard disk):
  - **X:\f6flpy-x64 (for Windows 8.1 64-bit)**
31. Click **Next**.
32. Follow the on-screen instructions to install the *Windows 8.1* operating system.

33. Install the **Windows** drivers from the **Device Drivers & Utilities + User's Manual** disc as per **Table 4 - 1, on page 4 - 3** (make sure you install the Intel Rapid Storage Technology driver - see overleaf).
34. Run the **Intel® Rapid Storage Technology** application to manage your RAID volume as instructed in **"Intel® Rapid Storage Technology for RAID Systems" on page 6 - 51**.

### IRST Driver Installation

1. Insert the **Device Drivers & Utilities + User's Manual** disc into the DVD drive.
2. Click **Option Drivers** (button).
3. Click **5.Install IRST Driver > Yes**.
4. Click **Next > Next**.
5. Click the check box to accept the license and click **Next**.
6. Click **Next > Next > Next**.
7. Click **Finish** to restart the computer.
8. See **"Intel® Rapid Storage Technology for RAID Systems" on page 6 - 51**.

## Deleting a RAID (Windows 8.1)

If you wish to delete an existing RAID then follow the procedure below to do so. However **backup up any necessary files and data before deleting a RAID**, as doing so will result in the loss of all data on the RAID volumes.

1. Start-up your notebook computer and press <F2> to enter the **BIOS**.
2. Go to **Intel(R) Rapid Storage Technology** (in the **Advanced** menu) and press <Enter>.
3. Go to the RAID (listed under **RAID Volumes:**) and press <Enter>.
4. Select **Delete** and press <Enter>.
5. Select **“Yes”** (note that all the data on the volumes will be lost) and press <Enter>.

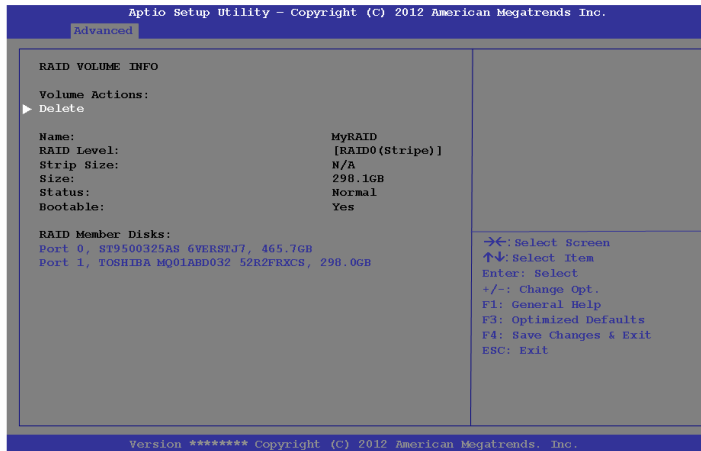

*Figure 6 - 5*  
**Delete RAID**  
**(Advanced > Intel(R)**  
**Rapid Storage**  
**Technology)**

### PC Camera Module

When the PC Camera application is run the LED indicator to the left of the camera will be illuminated in red (see ② *Figure 1 - 2 on page 1 - 7/Figure 1 - 3 on page 1 - 8/Figure 1 - 4 on page 1 - 9*). Note that you need to use the **Camera** app in *Windows 8.1* to take pictures and capture video. Use the **Fn + F10** key combination (see *“Function Keys & Visual Indicators” on page 1 - 16*) to toggle power to the PC Camera module.



## PC Camera Audio Setup

If you want to capture video & **audio** with your camera, it is necessary to setup the audio recording options in *Windows*.

1. Go to the **Control Panel**.
2. Click **Sound**  (**Hardware and Sound**) and click **Recording** (tab).
3. Right-click hold and release **Microphone** (VIA High Definition Audio) and make sure the item is not disabled.
4. Double-click **Microphone** (or select **Properties** from the right-click menu).
5. Click **Levels** (tab), and adjust the **Microphone** and **Microphone Boost** sliders to the level required.
6. Click **OK** and close the control panels.

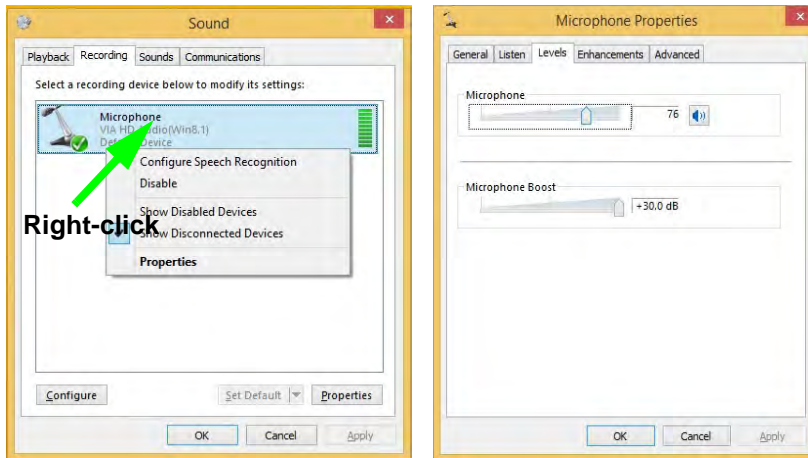
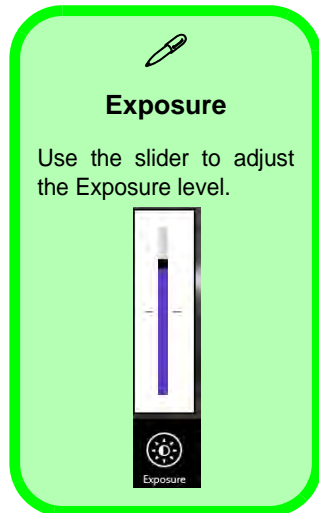

*Figure 6 - 6*  
**Audio Setup for PC  
Camera**

### Camera App



1. Run the **Camera** app from the Start screen by clicking on the **Camera** app icon .
2. The camera interface will display two buttons on the right side of the screen.

*Figure 6 - 7*  
**Camera App Buttons**

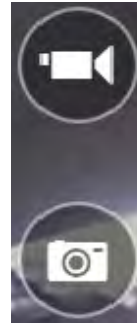

*Figure 6 - 8*  
**Camera Options**





3. The upper button  is used to record video, and the lower button  is used to take still pictures.
4. **Right-click** on the screen to bring up menu buttons at the bottom of the screen.
5. These buttons enable you to access the **camera roll** (where captured pictures and video are displayed), set the **timer** (the time period before capture begins; 3 seconds, 10 seconds or Off) and set the exposure level using the slider to obtain the best results.



## Camera Options

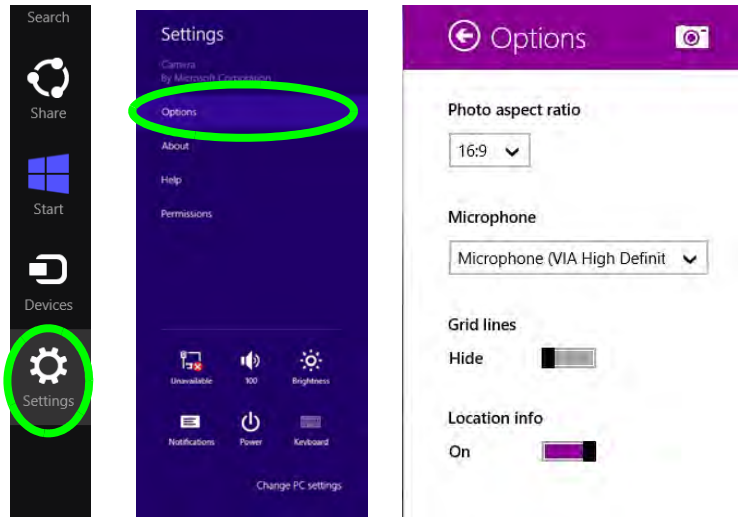

The **Camera Options** settings may be accessed as follows:

1. Run the **Camera** app from the **Start** screen by clicking on the **Camera** app icon .
2. While the camera app is running access the **Charms Bar** (e.g. click Use the **Windows** logo key  + **C** key combination).
3. Click **Settings** and then click **Options**.
4. You can adjust the **Photo Aspect Ratio**, select the **Microphone**, **Hide/Show** grid lines and turn Location Info on or off from the **Options** panel.



*Figure 6 - 9*  
**Camera Options**

### Taking Pictures/Capturing Video



1. Run the **Camera** app from the **Start** screen by clicking on the **Camera** app icon .
2. Right-click the screen and select the timer if you require a countdown before capture.
3. Click the appropriate icon to take a picture or start video capture (if video capture begins a timer will appear in the bottom corner of the screen).
4. To stop video capture click the main window again (or click the stop icon ).
5. Captured photos and videos will be saved to a **Camera Roll** folder within the **Pictures** folder.

6

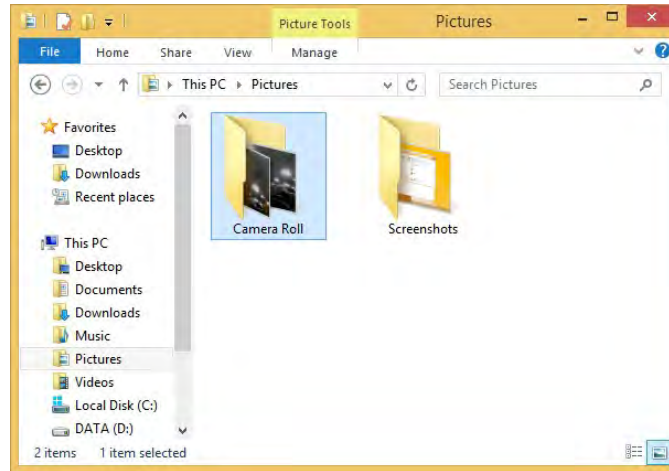
*Figure 6 - 10*  
**Pictures - Camera Roll**



## Camera Roll

1. Run the **Camera** app from the **Start** screen by clicking on the **Camera** app icon .
2. **Right-click** on the screen to bring up menu buttons at the bottom of the screen.
3. Click **Camera Roll**.
4. Click the arrows  /  (on either side of the screen) to browse through the captured photos/video, and back to the Camera app.

## Editing Photos

1. Clicking on a **captured photo** will bring up an app bar with a series of buttons.

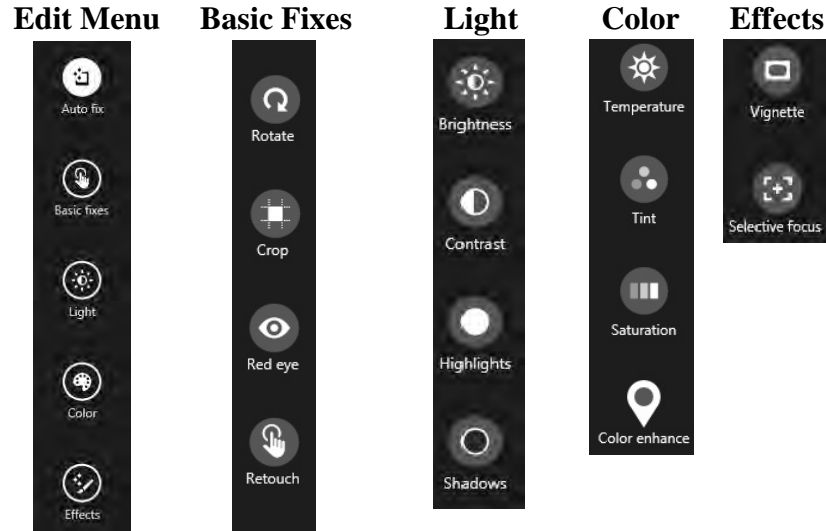

*Figure 6 - 11*  
**Edit Buttons**  
 (for Still Photos)

2. The **Camera** button will take you back to the home screen of the camera app.
3. Click **Delete** to remove any photo from the camera roll (you will be asked to click **Delete** again to confirm the deletion).
4. The **Open With** button will allow you to select a program with which to open the photo.
5. You can click **Set as Lock screen** to set the photo as the lock screen picture.
6. Clicking **Slide Show** will create a slide show of photos/video in the camera roll.
7. Click **Rotate** to rotate the picture through 90 degrees.
8. Use the handles to **Crop** any captured picture, and click **Apply** to make the changes (you can change the **Aspect** ratio by clicking the button and selecting an aspect ratio from the menu). You can **Save a copy** (create another copy of the

Figure 6 - 12  
Editing Tools

- photo with the edited changes), **Update original** (which changes the original picture permanently) or **Undo** any changes.
- Click the **Edit** button to bring up a full suite of tools to edit the photo.
- Click on the menu headings on the left, and then click on the tool on the right to edit the photo as required.



- After the editing process is completed right-click on the photo to **Save a copy** (create another copy of the photo with the edited changes), **Update original** (which changes the original picture permanently), **Undo** any changes or **Cancel** the editing.

## Editing Videos

1. Clicking on a **captured video** will bring up an app bar with a series of buttons.



*Figure 6 - 13*  
**Edit Buttons**  
 (for Video Files)

2. Click **Delete** to remove any video from the camera roll (you will be asked to click **Delete** again to confirm the deletion).
3. The **Open With** button will allow you to select a program with which to run the Video.
4. Clicking **Slide Show** will create a slide show of photos/video in the camera roll.
5. Click **Trim** to edit the video. Use the round buttons at either end of the slider to adjust the video length and click **Save a copy** to save the changes made.

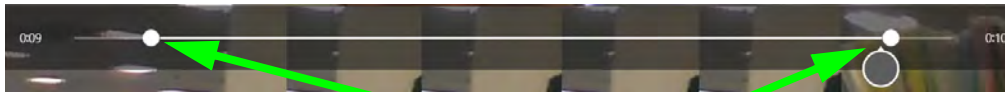

**Click to select and move the rounded buttons to edit the video.**

*Figure 6 - 14*  
**Trim Video**  
 (for Video Files)

### Video File Size

Note that capturing high resolution video files requires a substantial amount of disk space for each file. After recording video, check the video file size (right-click the file and select **Properties**) and the remaining free space on your hard disk (go to **My Computer**, right-click the hard disk, and select **Properties**). If necessary you can remove the recorded video file to a removable medium e.g. CD, DVD or USB Flash drive.

Note that the *Windows 8.1* system requires a minimum of **16GB (32-bit)** or **20GB (64-bit)** of free space on the **C: drive** system partition. In order to prevent system problems it is recommended that you move any large sized captured video file to a location other than the **C: drive**.



## Wireless LAN Module

If you have included an **Intel®** or **3rd Party WLAN** module in your purchase option make sure that the module is on (i.e. the system is not in **Airplane Mode**) before installing the driver.

Make sure you install the drivers in the order indicated in *Table 4 - 1, on page 4 - 3*.

*Note that you need to install both the WLAN & Bluetooth drivers for the WLAN & Bluetooth Combo modules, however the Qualcomm Atheros WLAN (Combo) module only requires the WLAN driver installation.*

See the appropriate driver installation instructions on the page indicated below:

- See “*3rd Party 802.11b/g/n Driver Installation*” on page 6 - 22.
- See “*Intel® WLAN Driver Installation*” on page 6 - 22.
- See “*Qualcomm Atheros WLAN Combo Driver Installation*” on page 6 - 23.



### Wireless Device Operation Aboard Aircraft

The use of any portable electronic transmission devices aboard aircraft is usually prohibited. Make sure the **WLAN & Bluetooth module(s)** are **OFF** if you are using the computer aboard aircraft by putting the system in to **Airplane Mode** (see *Table 1 - 4, on page 1 - 12/ Table 1 - 6, on page 1 - 16*).

### 3rd Party 802.11b/g/n Driver Installation

1. **Make sure the system is not in Airplane Mode**, and then insert the *Device Drivers & Utilities + User's Manual* disc into the DVD drive.
2. Click **Option Drivers** (button).
3. Click **1.Install WLAN Driver > Yes**.
4. Click **Next**.
5. Click **Finish** to restart the computer.
6. The operating system is the default setting for Wireless LAN control in *Windows* (see page [6 - 24](#)).

### Intel® WLAN Driver Installation

1. **Make sure the system is not in Airplane Mode**, and then insert the *Device Drivers & Utilities + User's Manual* disc into the DVD drive.
2. Click **Option Drivers** (button).
3. Click **1.Install WLAN Driver > Yes**.
4. Click in the check box to agree to the **End User License Agreement** and click **Install**.
5. Click **Finish**.
6. The operating system is the default setting for Wireless LAN control in *Windows* (see page [6 - 24](#)).

## Qualcomm Atheros WLAN Combo Driver Installation

1. **Make sure the system is not in Airplane Mode**, and then insert the *Device Drivers & Utilities + User's Manual* disc into the DVD drive.
2. Click **Option Drivers** (button).
3. Click **1.Install WLAN Driver > Yes**.
4. Select the language preferred and click **Next**.
5. Click **Next > Next**.
6. Click in the check box to accept to the **License Agreement** and click **Next**.
7. Click **Finish**.
8. Click **Yes** to restart the computer.
9. The operating system is the default setting for Wireless LAN control in *Windows* (see page [6 - 24](#)), and *“Bluetooth Configuration in Windows”* on [page 6 - 47](#) (note that no Bluetooth driver is required for this module).

### WLAN Configuration in Windows

You can configure a wireless connection using one of the following options, however make sure the Wireless LAN module is turned on (and not in Airplane Mode) before configuration begins.

#### Charms Bar

1. Go to the **Charms Bar**.
2. Select **Settings** and then click the **WiFi icon** (it should read **Available** under the icon and **Airplane mode** should be **Off**).
3. A list of available access points will appear.

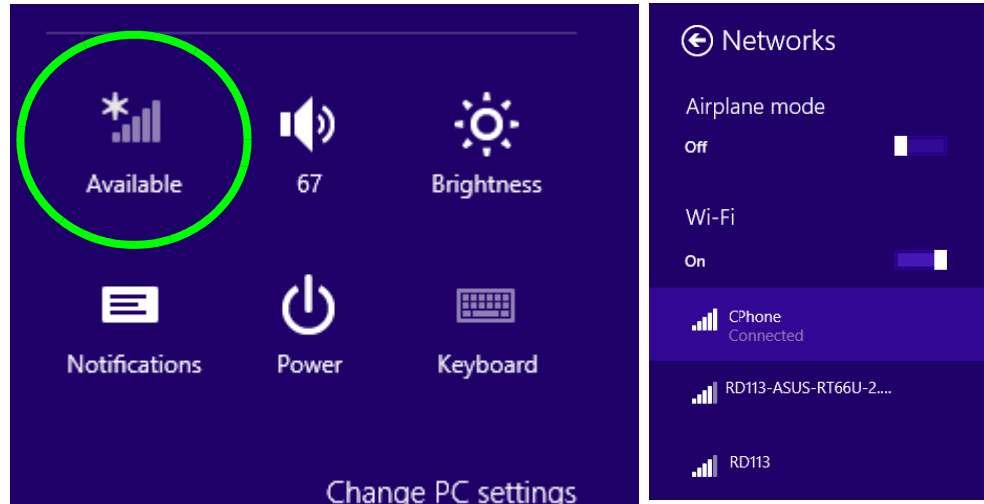

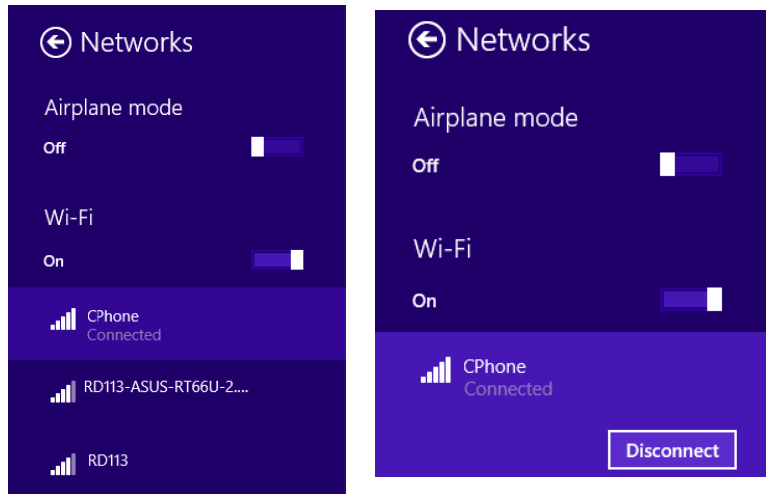

Figure 6 - 15  
WiFi Settings  
(Charms Bar) &  
Networks



4. Double-click an access point to connect to it (or click it and click **Connect**).
5. Enter a network security key (password) if required, and click **Next**.
6. You can choose to find other devices or not.
7. When you are connected to the network access point it will display **Connected** .
8. Select any connected network and click **Disconnect**  to disconnect from a connected access point.



9. You can click the **Airplane Mode** button to turn the mode (including Bluetooth) On or Off.
10. Alternatively you can click the **WiFi** button to turn just the WiFi On or Off.

*Figure 6 - 16*  
**Networks  
Connected /  
Disconnect**

### Desktop Mode

1. Switch to the Windows Desktop (click the app or use the Windows logo key  + **D** key combination).
2. Click the wireless icon  in the notification area of the taskbar.
3. A list of available access points will appear.
4. Double-click an access point to connect to it (or click it and click **Connect**).
5. Enter a network security key (password) if required, and click **Next**.
6. You can choose to find other devices or not.
7. Select any connected network and click **Disconnect** to disconnect from a connected access point.

6

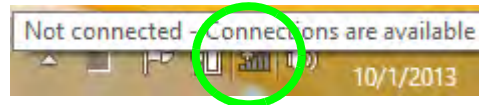

*Figure 6 - 17*  
**Windows Desktop  
Taskbar Notification  
Area WLAN  
Connection**

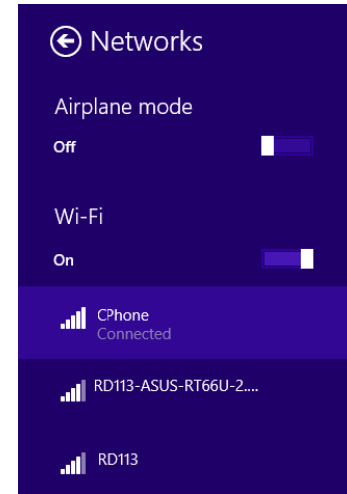
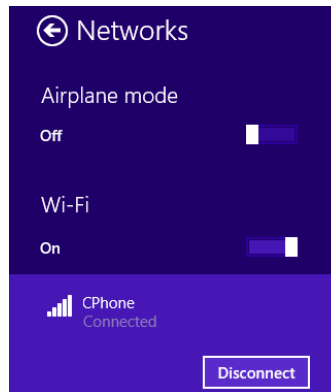

# Fingerprint Reader Module

(For Model A/C Computers Only)

The fingerprint reader module provides a high level of security for your computer. Make sure you have administrator's rights to your computer, and have a **Windows** password enabled for full security protection.

There are two different fingerprint modules supplied with this model. Install the driver from the **Device Drivers & Utilities + User's Manual** disc by following the appropriate instructions on the page overleaf.

The fingerprint reader module uses the **Sign-in options** configuration of the **Windows Account**.



## Fingerprint Reader and Power Saving States

If your computer is in a power saving state (e.g. Hibernate or Sleep) you should keep your finger clear of the fingerprint sensor.

Allow the system to fully resume before swiping your finger across the sensor.

### AuthenTec Fingerprint Reader Driver Installation

1. Insert the *Device Drivers & Utilities + User's Manual* disc into the CD/DVD drive.
2. Click **Option Drivers**.
3. Click **2.Install Finger Print Driver > Yes**.
4. Click **Next**.
5. Click **Finish** to restart the computer.
6. The fingerprint reader module uses the **Sign-in options** configuration of the **Windows Account** (see overleaf).

### BioExcess Fingerprint Reader Driver Installation

1. Insert the *Device Drivers & Utilities + User's Manual* disc into the CD/DVD drive.
2. Click **Option Drivers**.
3. Click **2.Install Finger Print Driver > Yes**.
4. Click **Next > Install**.
5. Click **Finish** to complete the installation.
6. The fingerprint reader module uses the **Sign-in options** configuration of the **Windows Account** (see overleaf).



## Fingerprint Module Configuration

1. Go to the **Charms Bar**.
2. Select **Settings** and then click **Change PC Settings**.
3. Click **Accounts** and then click **Sign-in options**.
4. You will need to add a **Windows** password (click **Add** under **Password**).
5. After you have added the password you will need to restart the computer and use your password to log on to the system.
6. Go to the **Charms Bar**.
7. Select **Settings** and then click **Change PC Settings**.
8. Click **Accounts** and then click **Sign-in options**.
9. Click **Add** under **Fingerprint**.

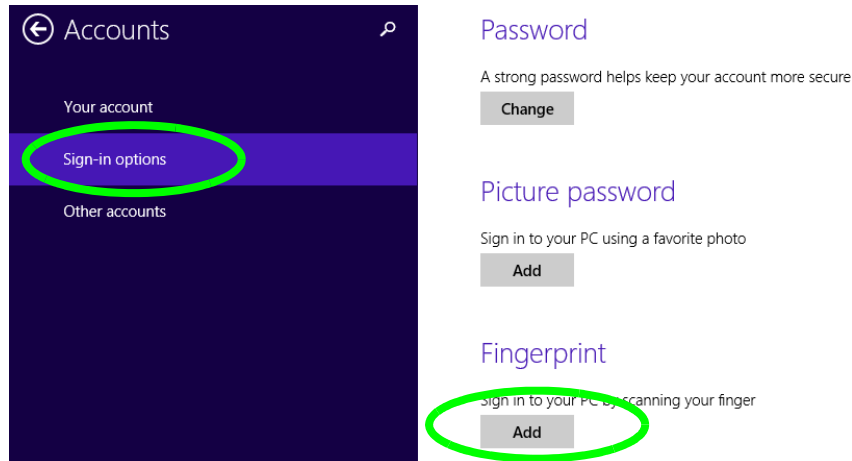

*Figure 6 - 18*  
**Accounts - Sign-in  
Options  
(Add Fingerprint)**

10. Input the **Windows password** and click **OK**.
11. You will then be instructed to **swipe the same finger** across the reader a number of times.

*Figure 6 - 19*  
**Add a Fingerprint**

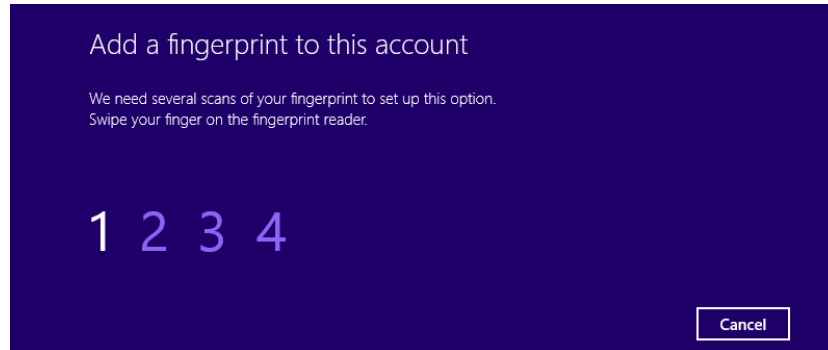

12. Click **Finish**.
13. You can choose to **Add another** finger (this is recommended) or **Remove** the current fingerprint reading.
14. You can now scan your fingerprint to log-on to the computer.

# Trusted Platform Module

## (Factory Option Only)

The **TPM security chip** allows you to create and manage digital certificates for user and platform authentication. This type of security is usually administered within large enterprises and organizations, and therefore requires implementation by a system administrator before users can access security features.

Individual users can use the TPM as an authentication with the fingerprint reader.

Make sure you have administrator's rights to your computer, and have a *Windows* password enabled for full security protection. In addition **Make sure you prepare a removable media (e.g. a USB flash drive) to store passwords etc. before beginning the TPM initialization process.**

Before setting up the TPM functions you must initialize the security platform.

## Enabling & Activating TPM

1. Restart the computer.
2. Enter the **Aptio Setup Utility** pressing **F2** during the POST/startup.
3. Use the arrow keys to select the **Security** menu.
4. Select **TPM Configuration** and press Enter to access the sub-menu.
5. Press Enter to access the **TPM Support** menu and select **Enable** to display the full **TPM configuration** menu.
6. Select **TPM State**, press Enter and select **Enabled** to change the TPM state to enabled. You will then need to press **F4** to save the changes and restart the computer.

6

*Figure 6 - 20*  
**TPM State**  
**(Enabled)**



7. As the computer restarts press **F2** to enter the BIOS again and go to the **TPM Configuration** menu.

8. Select **Pending operation**, press Enter and select the option you require (if you are initializing TPM you should select **Enable Take Ownership** and press Enter). You will then need to press **F4** to save the changes and restart the computer.

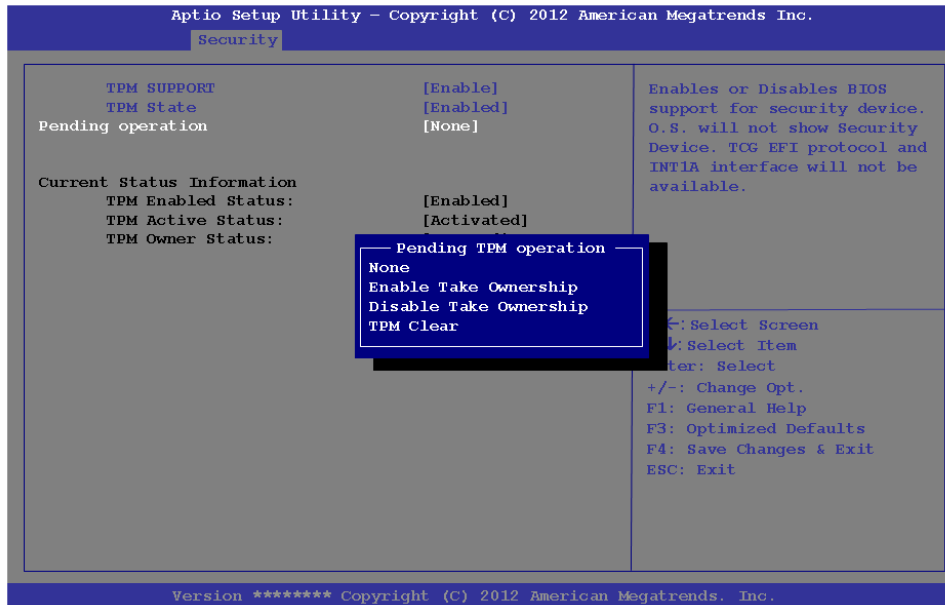



Figure 6 - 21  
Pending TPM  
operation  
(Enable Take  
Ownership)

9. You can now **install the TPM driver** (see ***“Trusted Platform Module (TPM) Driver Installation” on page 6 - 34***) and then initialize the TPM.

### Trusted Platform Module (TPM) Driver Installation

1. Make sure you have enabled and activated the TPM in the BIOS before installing the driver.
2. Insert the *Device Drivers & Utilities + User's Manual* disc into the DVD drive.
3. Click **Option Drivers** (button).
4. Click **3.Install TPM Driver > Yes**.
5. Click **Next**.
6. Click the button to accept the license and click **Next**.
7. Click **Next > Next > Install**.
8. Click **Finish > Yes** to restart the computer.

## Initializing TPM

1. Switch to the Desktop app and click the TPM icon right-click the icon  in the notification area of the taskbar, and select **Security Platform Initialization** (or click the **Security Platform State** taskbar bubble).
2. Click **User Settings** (tab) and click **Yes**, or right-click the icon  in the notification area of the taskbar, and select **Security Platform Initialization** (or click the **Security Platform State** taskbar bubble).
3. The **Quick Initialization** method will automatically be selected for you (if you need to use advanced settings provided by your network administrator then select **Advanced Initialization**).
4. You will need to use a removable media (e.g. a USB Flash Drive) to store passwords and data (keep the media in a safe place until required).
5. Select the drive you want to use from the drop-down menu and click **Next**.



*Figure 6 - 22*  
**Security Platform  
 Quick Initialization  
 Wizard**

## Modules



### Help

Right-click the icon  in the notification area of the taskbar to bring up the menu to select **Help** or **How to use the Security Platform Features**.

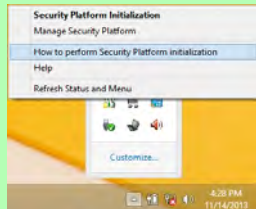



You can also click the **Help** button in any of the Infineon Security Platform Settings Tool tabs to bring up specific help topics on each tab.

Figure 6 - 23  
Settings

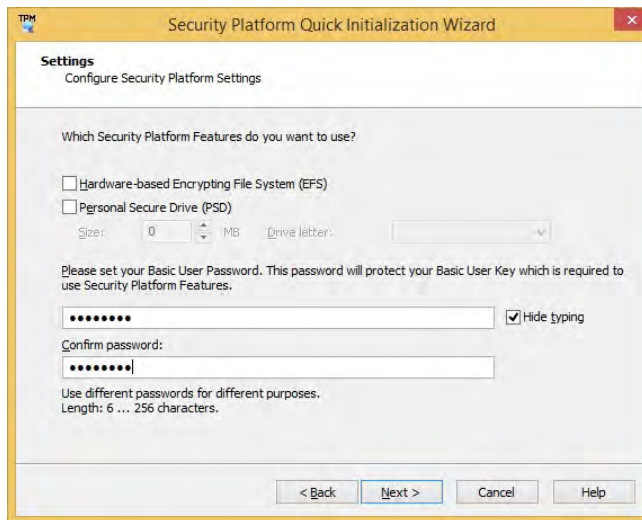
6. Choose the **Security Platform Features** you want to use by clicking the appropriate check box.
7. Enter a **Basic User Password** (and re-type to confirm it) and click **Next**.



8. Click **Next** to confirm the settings.
9. The computer will then initialize the settings.
10. Click **Finish**.
11. Click the tabs and control panels to adjust the settings.
12. Double-click the icon  in the taskbar notification area to access the **Infineon Security Platform Settings Tool**, or right-click the icon  and select a menu item.



## Infineon Security Platform Settings Tool

The Infineon Security Platform Settings Tool allows you to manage and check the TPM state, manage your password information, and to backup and restore the TPM data. As TPM is usually administered within large enterprises and organizations, your system administrator will need to assist you in managing the information here.



### Menus

Note that not all the menus pictured here will be available for access. The menu items that appear will be dependent on your configuration settings etc. (see the **Help** file for full details).

*Figure 6 - 24*  
**Infineon Security Platform Settings Tool**

### User Settings

This page allows the settings to be configured for the currently logged in Infineon Security Platform user including the ability to change the password, configure secure e-mail, file and folder encryption and Enhanced Authentication. You can also import or delete certificates protected by the security platform.

*Figure 6 - 25*  
**Infineon Security Platform Settings Tool (User Settings)**

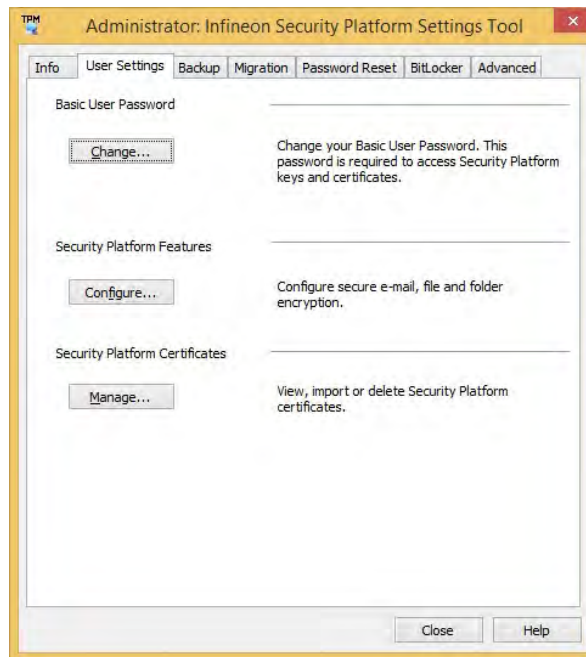

## Backup

Here you can configure backup and restore operations. Backup files contain the computer identification and user identification information which is used to match the machine name and user name with the current machine and user during restoration.

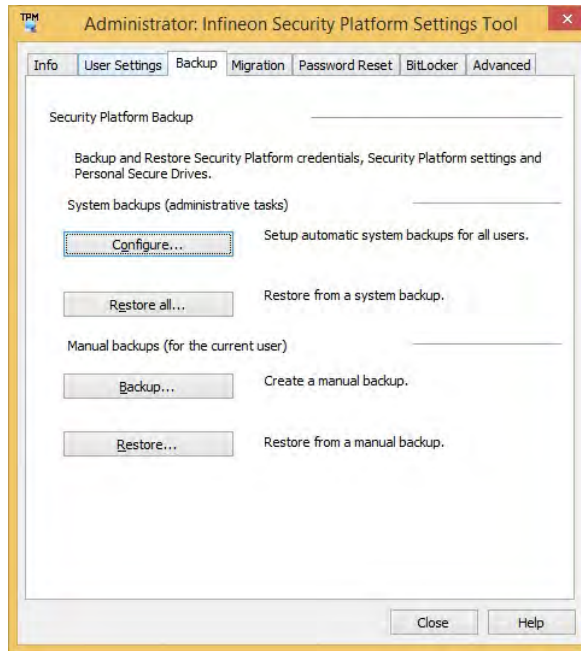

*Figure 6 - 26*  
**Infineon Security Platform Settings Tool (Backup)**

### Migration

The Migration tab is used to help securely transfer keys and certificates from one platform to another.

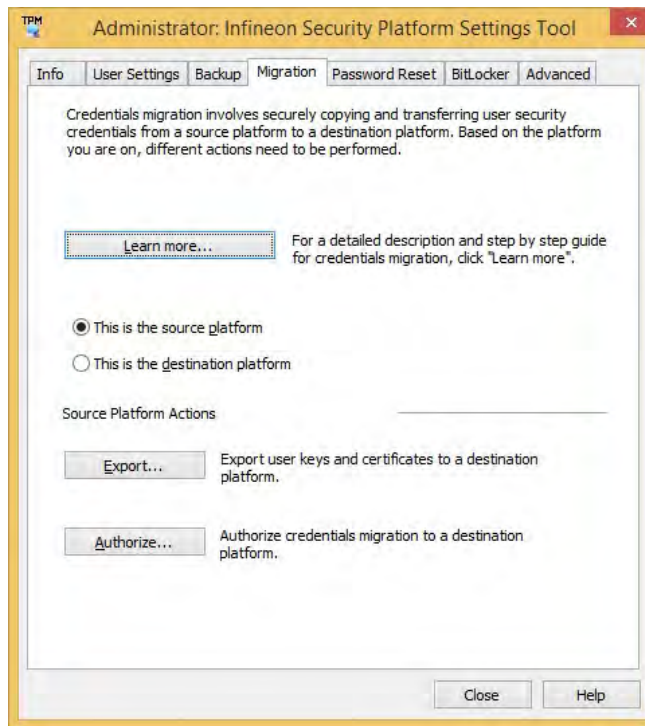

*Figure 6 - 27*  
**Infineon Security Platform Settings Tool (Migration)**

## Password Reset

Use Password Reset to reset basic user passwords when required.

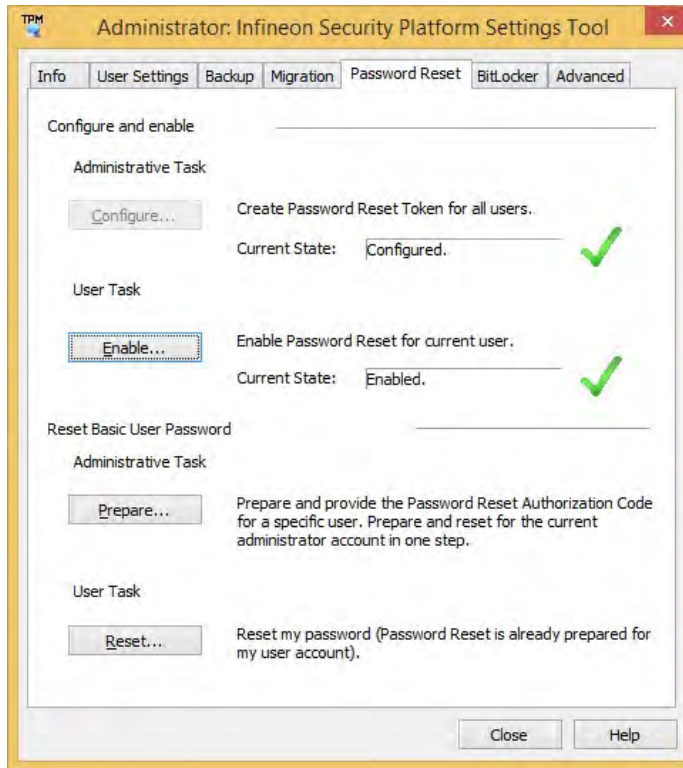
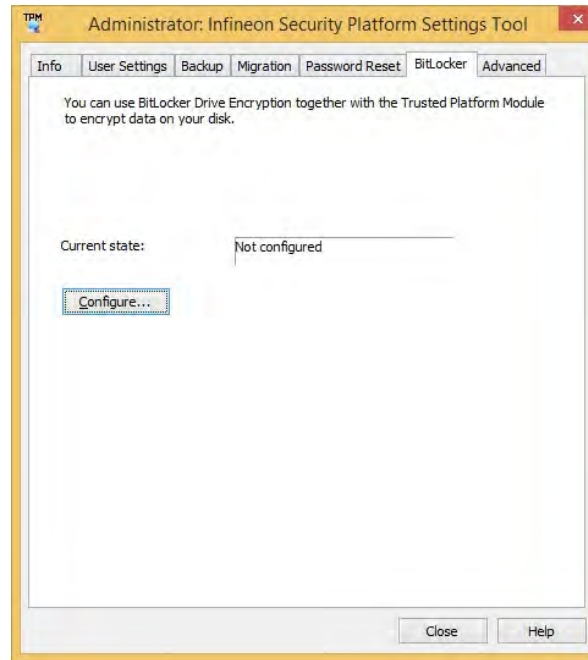

*Figure 6 - 28*  
**Infineon Security  
Platform Settings  
Tool  
(Password Reset)**

### BitLocker

BitLocker Drive Encryption can be used in conjunction with the TPM to encrypt data on the disk and is done via the **Microsoft BitLocker Control Panel Applet**. Click **Configure** and select a drive to be encrypted and then follow the Wizard to begin the encryption process.

*Figure 6 - 29*  
**Infineon Security  
Platform Settings  
Tool  
(BitLocker)**



Access the Microsoft **BitLocker Drive Encryption** control panel applet from the *Windows* control panel (**System and Security**).

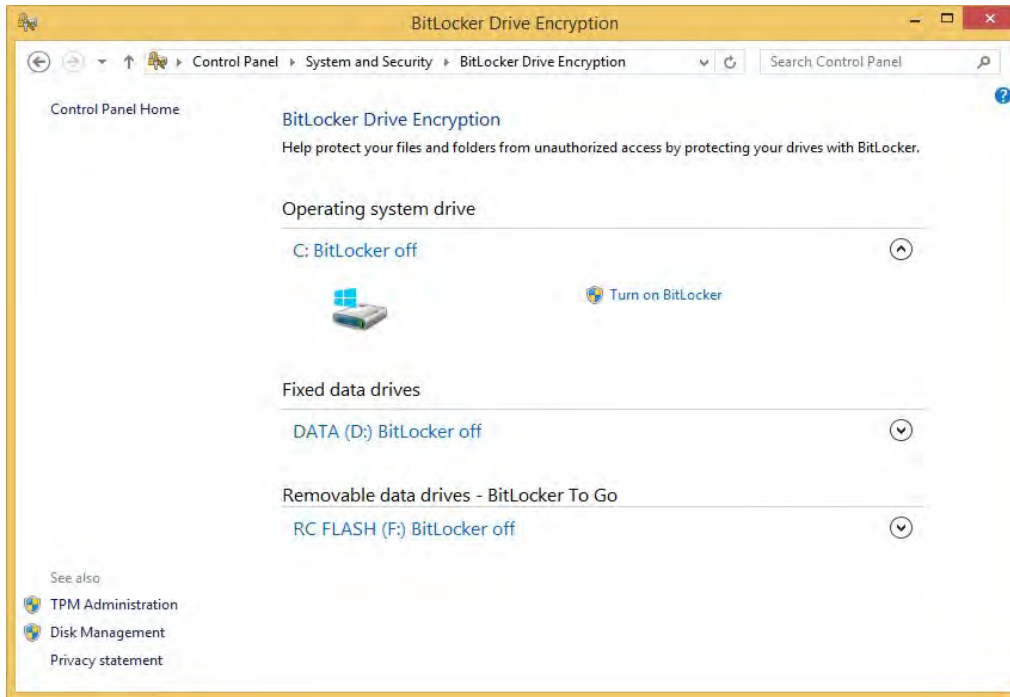
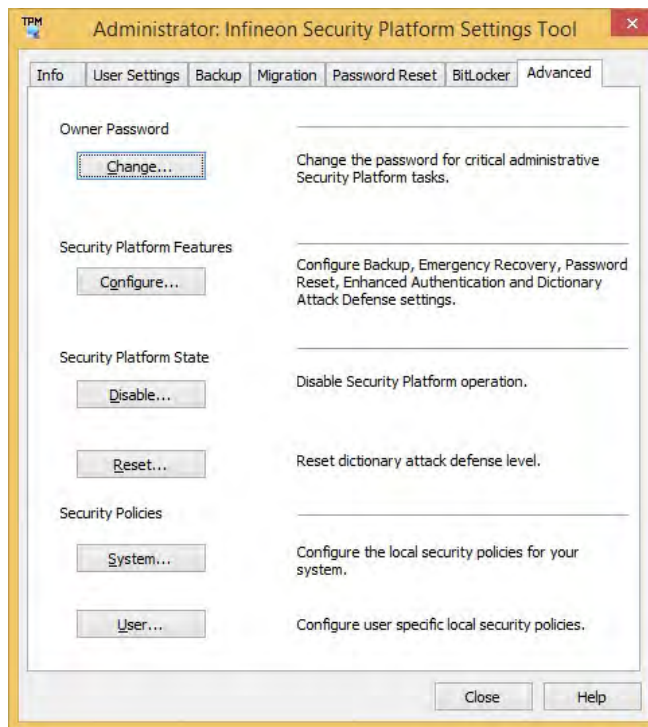

*Figure 6 - 30*  
**BitLocker Drive Encryption**

### Advanced

Configure all the Security Platform owner and policy settings from the Advanced tab. The settings that can be changed are for the local computer only.

*Figure 6 - 31*  
**Infineon Security  
Platform Settings  
Tool  
(Advanced)**





## Bluetooth & WLAN Combo Module

If your purchase option includes the **Combination Wireless LAN & Bluetooth module** (either **Intel®** or **3rd Party**) then install the driver as instructed overleaf.

Make sure that the module is on (i.e. the system is not in **Airplane Mode**) before installing the driver.



### Bluetooth Data Transfer

Note that the transfer of data between the computer and a Bluetooth enabled device is supported in one direction only (simultaneous data transfer is not supported). Therefore if you are copying a file from your computer to a Bluetooth enabled device, you will not be able to copy a file from the Bluetooth enabled device to your computer until the file transfer process from the computer has been completed.



### High Speed Bluetooth Data Transfer

The **Combination Wireless LAN & Bluetooth module** supports high speed data transfer. However to achieve such transfer speeds, **both devices must support high speed data transfer.**

**To obtain high speed data transfer make sure that both the WLAN and Bluetooth modules are powered on.**

Check your Bluetooth compatible device's documentation to confirm it supports high speed data transfer.

### 3rd Party Bluetooth (V4.0) Combo Driver Installation

1. **Make sure the system is not in Airplane Mode**, and then insert the *Device Drivers & Utilities + User's Manual* disc into the DVD drive.
2. Click **Option Drivers** (button).
3. Click **4.Install Combo BT Driver > Yes.**
4. Click **Next.**
5. Click **Finish** to restart the computer.
6. See *“Bluetooth Configuration in Windows” on page 6 - 47* for configuration instructions.



### Intel Bluetooth Combo Driver Installation

1. **Make sure the system is not in Airplane Mode**, and then insert the *Device Drivers & Utilities + User's Manual* disc into the DVD drive.
2. Click **Option Drivers** (button).
3. Click **4.Install Combo BT Driver > Yes.**
4. Click **Next.**
5. Click in the check box to accept the license and click **Next > Next.**
6. Click **Yes** to restart the computer.
7. See *“Bluetooth Configuration in Windows” on page 6 - 47* for configuration instructions.

## Bluetooth Configuration in Windows

You can configure a Bluetooth connection as below, however make sure the Bluetooth module is on (or the system is not in Airplane Mode) before configuration.

### Desktop Mode

1. Switch to the Windows Desktop (click the App or use the Windows logo key  + **D** key combination).
  2. Click the notification area of the taskbar and double-click the Bluetooth icon  (or click and select **Show Bluetooth Devices**).
  3. The **Bluetooth** item in **PC and Devices** will appear.
- OR**

### Charms Bar

1. Go to the **Charms Bar**.
2. Select **Settings** and then click **Change PC Settings**.
3. Select the **Bluetooth** item in **PC and Devices**.

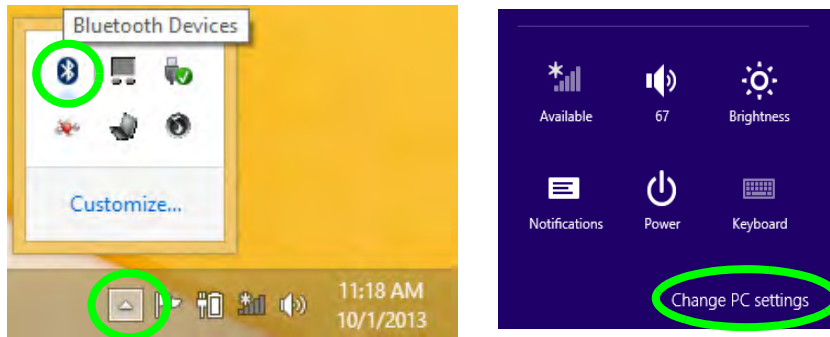

*Figure 6 - 32*  
**Bluetooth Taskbar  
Icon & Change PC  
Settings (Charms  
Bar -Settings)**

4. Make sure that Bluetooth is turned on and a list of discovered devices will appear.
5. Double-click the device you want to pair with the computer and click **Pair**.

*Figure 6 - 33*  
**PC and Devices -  
Bluetooth**

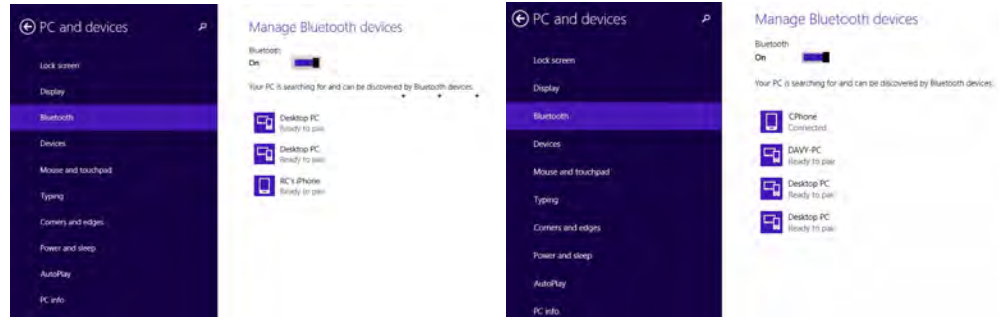

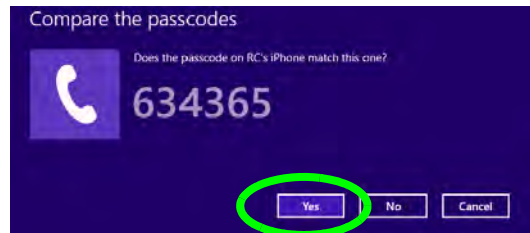

6. On first connection the computer will provide you with a pairing code to be entered onto the device.

*Figure 6 - 34*  
**Enter the Passcode**



7. Enter the code into your Bluetooth enabled device and click **Yes** on the computer to complete the pairing.
8. Select a device and click **Remove Device** to disconnect from any device.

## To Make your Computer Discoverable to Bluetooth Devices

1. Switch to the Windows Desktop (click the app or use the Windows logo key  + **D** key combination).
2. Click the notification area of the taskbar, click the Bluetooth icon  and click **Open Settings**.
3. Click **Options**, and make sure that **Allow Bluetooth devices to find this computer** check box (**Discovery**) has a check inside it.
4. Make sure that the **Alert me when a new Bluetooth device wants to connect** check box (**Connections**) has a check inside it, if you want to be notified when a Bluetooth device wants to connect.

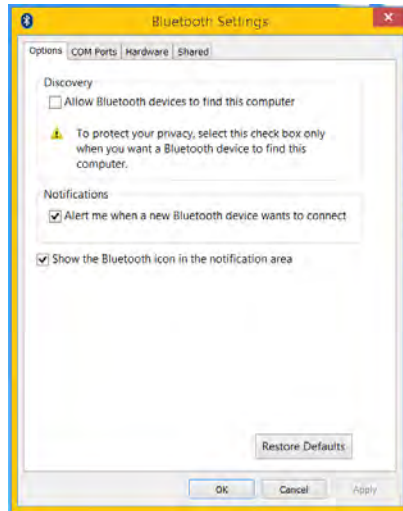

Figure 6 - 35  
Bluetooth Settings

## Intel® Rapid Storage Technology

The **Intel Rapid Storage Technology application** provides high-performance SATA and SATA RAID capabilities. Install the **Intel Rapid Storage Technology application** (after installing all necessary drivers in the correct order) to support your **RAID** (if you have two HDDs/SSDs installed) system, or SATA drive if set up in **AHCI mode**, in the BIOS (see “*SATA Mode (Advanced Menu)*” on page 5 - 10).

See “*Intel® Smart Response Technology*” on page 6 - 55 for further information on setting up Smart Response.

### IRST Driver Installation

1. Insert the *Device Drivers & Utilities + User’s Manual* disc into an attached DVD drive.
2. Click **Option Drivers** (button).
3. Click **5.Install IRST Driver > Yes**.
4. Click **Next**.
5. Click the check box to accept the license and click **Next**.
6. Click **Next > Next > Next**.
7. Click **Finish** to restart the computer.

See the following pages for more information if you have set your hard disks up in a RAID configuration.

## Intel® Rapid Storage Technology for RAID Systems

**Intel® Rapid Storage Technology** application displays status information on your RAID configuration. Run the **Intel® Rapid Storage Technology** application from the item in the **Start** menu.

When the **Intel® Rapid Storage Technology** application is launched the system will open the **Status** window. Here you can view the general health of the storage system. Various volume creation and management options are available depending on the system's status.

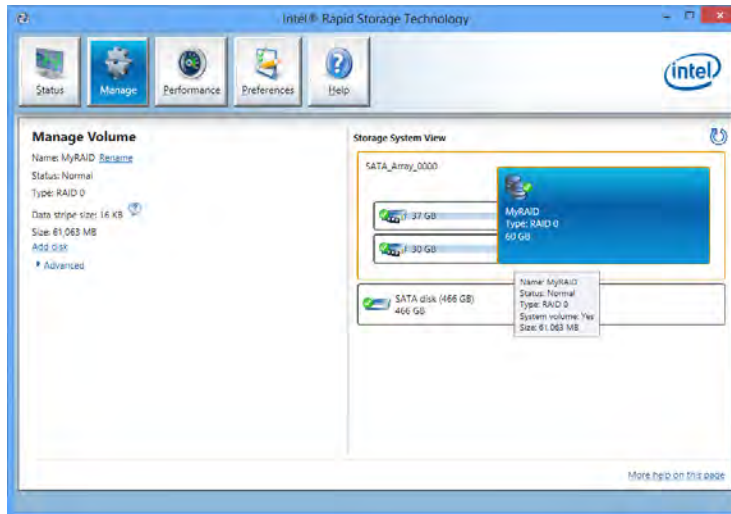

*Figure 6 - 36*  
**Intel® Rapid  
Storage Technology  
Status**



### Help

Click the **Help** (or press **F1**) menu button at the top of the **Intel® Rapid Storage Technology** application.

Click **Contents** to view the general list of subjects covered, click **Index** or **Search** for a more specific help topics on a particular item.

Click **More help on this page** at the bottom of any page for page specific help.

*Figure 6 - 37*  
**Intel® Rapid Storage Technology Help**

## Intel® Rapid Storage Technology Help

If a hard drive member of a RAID volume is reported as **“Degraded”** or **“Failed”** it may be possible to recover the volume. If the volume cannot be restored then you will need to recreate the RAID volume and restore the data from a back up. Click the **Help** menu (or press **F1**) for instructions on how to recover or recreate RAID Volumes.

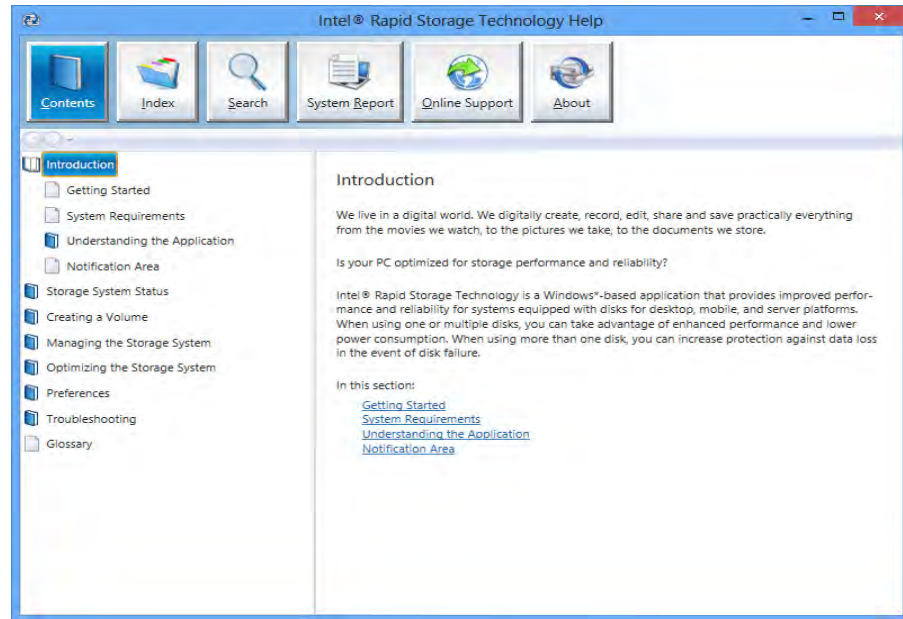



## RAID Volume Data Verification and Repair

The RAID volume data verification process identifies any inconsistencies or bad data on a RAID 0 or RAID 1 volume. The table outlines what occurs for each RAID level:

RAID Level	Verify	Verify & Repair
RAID 0	Bad blocks are identified.	N/A
RAID 1	Bad blocks are identified. Data on the mirrored drive is compared to data on the source drive.	Bad blocks are reassigned. If the data on the mirrored drive does not match the data on the source drive, the data on the mirrored drive is overwritten by the data on the source.

*Table 6 - 2*  
**RAID Level  
Verification &  
Repair Status**

## Replacing and Reverting Recovery and Master Volumes

If a master or recovery drive fails you will need to add a new identical drive and rebuild the recovery volume to the drive. You can also revert the master drive to the state of the previous volume update. For details on how to do this see the help file *“Intel® Rapid Storage Technology Help” on page 6 - 52.*

See over for details on how to verify and repair RAID volume data. Verification will identify and repair data inconsistencies on the volume.

## Verifying and Repairing RAID Volume Data

1. Run the **Intel® Rapid Storage Technology** application.
2. Click to **select the RAID** in the pane on the right side of the window.
3. Click **Manage** and click **Advanced**.
4. Click **Verify**, then click **Verify** (button) to begin the process.
5. The completion percentage will be listed under **Status** (Verifying)
6. Click **Close** to complete the process.

6

*Figure 6 - 38*  
**Intel® Rapid Storage Technology Verify**

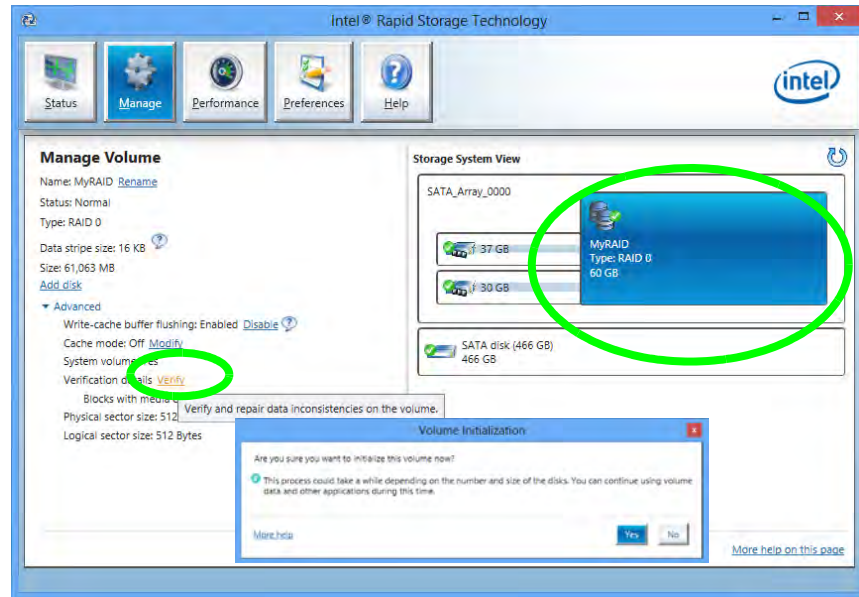



### Enabling Intel Smart Response Technology

1. Run the **Intel® Rapid Storage Technology** application.
2. Click **Enable acceleration** under **Performance > Smart Response Technology** (*note that you will at least 5MB of free unpartitioned and unallocated space on the SSD otherwise the Smart Response Technology item will not appear*).

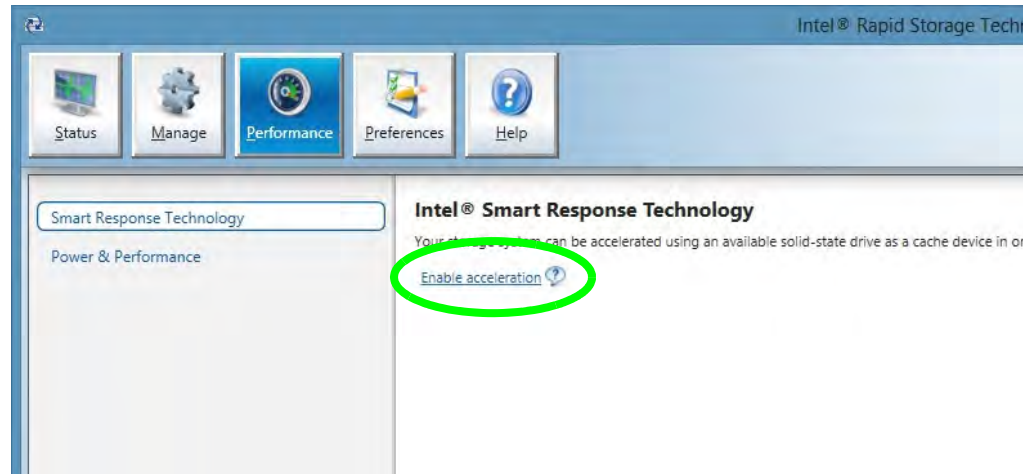

**6**  
*Figure 6 - 40*  
**Intel® Rapid Storage Technology - Performance Enable Acceleration**

3. Select the SSD to be used as a cache device.
4. Select the size from the SSD to be allocated for the cache memory (any remaining space on the SSD can be used for data storage using the simple data single-disk RAID 0 volume that is automatically created).

5. Select the HDD (or RAID volume) to be accelerated (it is highly recommended that you accelerate the system volume or system disk for maximum performance).
6. Select the acceleration mode, and then click **OK** (Enhanced mode is selected by default).

**Note:** **Enhanced mode** (default): Acceleration optimized for data protection.

**Maximized mode:** Acceleration optimized for input/output performance.

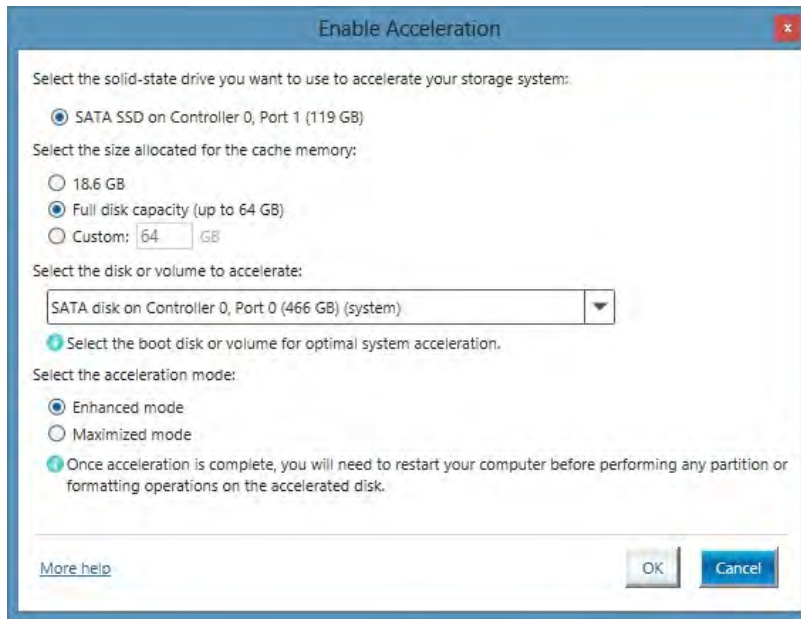

*Figure 6 - 41*  
**Enable  
Acceleration  
Options**

- The page will refresh and report the new configuration in under **Performance > Smart Response Technology**.



6  
*Figure 6 - 42*  
**Intel® Rapid Storage Technology - Performance (Smart Response Technology)**

# Intel® Rapid Start Technology Driver

**Intel(R) Rapid Start Technology** can resume power from Hibernation within 5 to 6 seconds and can remember your computer's previous state with zero power.

## System Requirements to support Intel® Rapid Start Technology:

- Rapid Start Technology should be enabled in the BIOS (see ““*Intel(R) Rapid Start Technology (Advanced Menu)*” on page 5 - 10).
- Intel Rapid Storage Technology software installed.
- A Solid State Drive (SSD) with a minimum capacity of 18.6GB.
- The Solid State Drive (not the HDD) must be configured as outlined on the following pages to support Rapid Start Technology.
- The **Windows** operating system must be installed on the system hard disk drive, and not on the Solid State Drive (SSD).



### Operating System Installation

Note that in order for **Intel(R) Rapid Start Technology** to function properly the **Windows** operating system must be installed on the system hard disk drive (e.g. the “C:” drive), and the SSD should be configured as outlined on the following pages. Rapid Start will not function if the operating system is installed on the SSD.

See overleaf for instructions on enabling **Intel® Rapid Start Technology**.

## Intel® Rapid Start Technology Configuration

1. Enable/disable Intel(R) Rapid Start Technology from the BIOS (see *“Intel(R) Rapid Start Technology (Advanced Menu)” on page 5 - 10*).
2. Go the **Windows** control panel and double-click **Administrative Tools (System and Security)**> **Computer Management** > **Storage** > **Disk Management**
3. Right-click the SSD and select **Shrink Volume** from the menu.

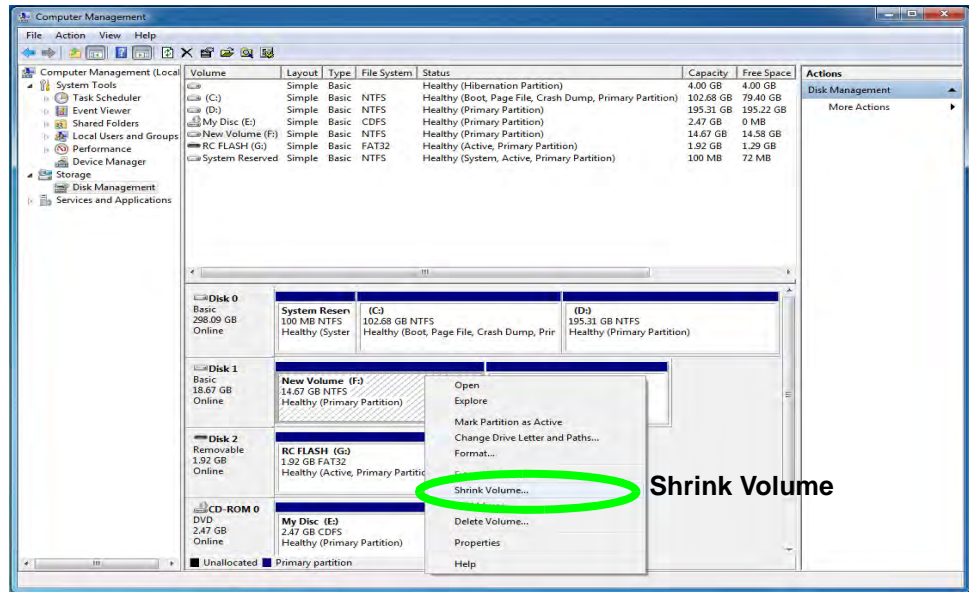
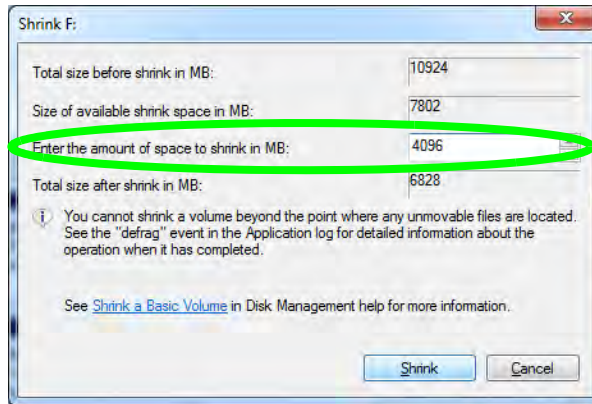

Figure 6 - 43  
Computer Management  
(Shrink SSD Volume)



4. Enter the figure, **which should be equal to amount of system memory (RAM) in your computer**, in “Enter the amount of space to shrink in MB”.



*Figure 6 - 44*  
**Shrink Volume Size**

5. Click **Shrink** (any unallocated file space may be formatted for storage use).



### Memory Size (Amount of Space to Shrink)

The figure entered in the “**Enter the amount of space to shrink in MB**” field above should be equal to the amount of system memory in your computer. In the example above the system memory is 4GB ( $1024\text{MB} * 4 = 4096\text{GB}$ ). If you are unsure of your total system memory (RAM) then go to **System** control panel (System and Security) and check **Installed memory (RAM)**. The memory size will be displayed in GB so convert by multiplying the GB figure by 1024 to get the total in MB (e.g. 8GB = 8192MB).

6. Run the Desktop app and right-click the lower left hot corner (or use the **Windows Logo Key** + X key combination) and select **Command Prompt (Admin)**.

*Figure 6 - 45*  
Search for CMD  
Prompt

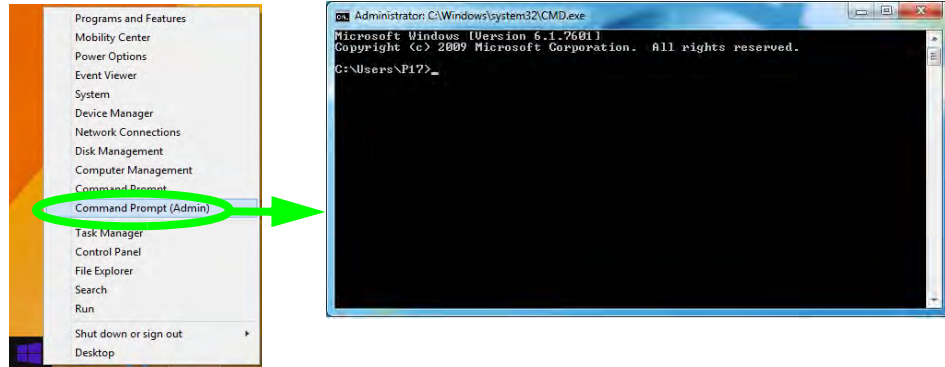

7. Type "**DISKPART**".
8. At the DISKPART command type "**list disk**".

*Figure 6 - 46*  
Diskpart - List Disk



- Type “**select disk #**” (# is disk number where you want to create the store partition, so refer to the results obtained from “**list disk**” for exact disk number).
- The message “**Disk # is now the selected disk.**” will appear.

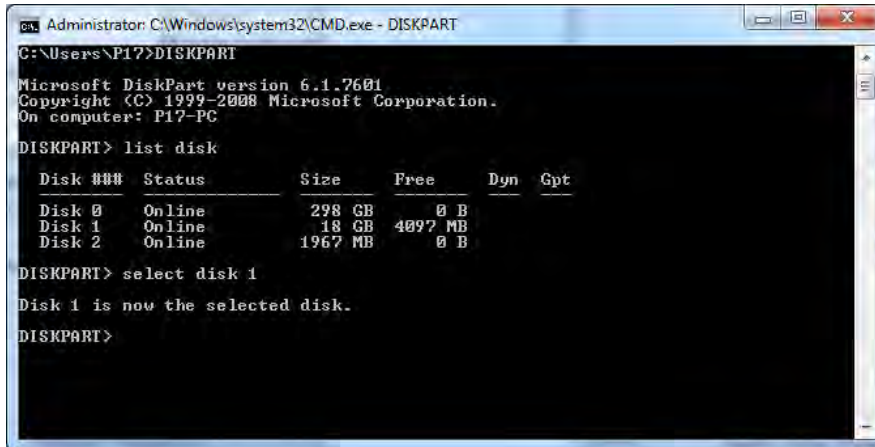

```
Administrator: C:\Windows\system32\CMD.exe - DISKPART
C:\Users\P17>DISKPART
Microsoft DiskPart version 6.1.7601
Copyright (C) 1999-2008 Microsoft Corporation.
On computer: P17-PC
DISKPART> list disk

   Disk ###  Status              Size               Free              Dyn  Gpt
   -----  -
   Disk 0    Online              298 GB              0 B
   Disk 1    Online              18 GB              4097 MB
   Disk 2    Online              1967 MB             0 B

DISKPART> select disk 1
Disk 1 is now the selected disk.
DISKPART>
```

*Figure 6 - 47*  
Diskpart - Select  
Disk #

- Type “**create partition primary**”.
- A “**DiskPart succeeded in creating the specified partition.**” message should appear.

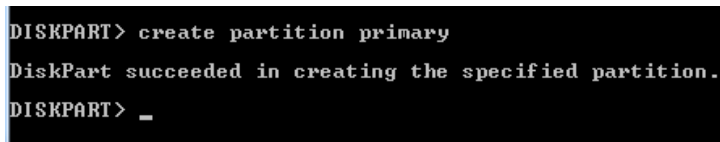

```
DISKPART> create partition primary
DiskPart succeeded in creating the specified partition.
DISKPART>
```

*Figure 6 - 48*  
Diskpart - Create  
Partition

13. Type “detail disk”.

Figure 6 - 49  
Diskpart - Detail  
Disk

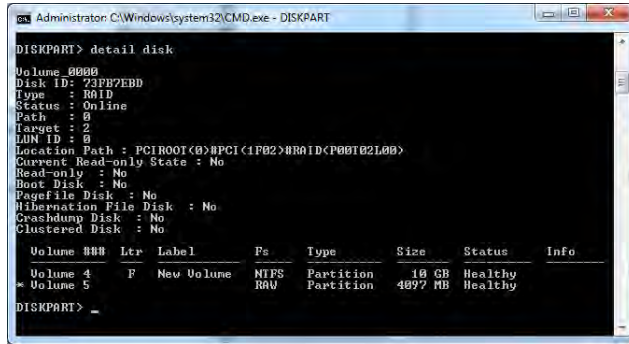

- 14. Type “select Volume #” (# is volume of your storage partition so refer to results obtained from "detail disk" for the exact volume number).
- 15. The message “Volume # is now the selected volume.” will appear.

Figure 6 - 50  
Diskpart - Select  
Volume #

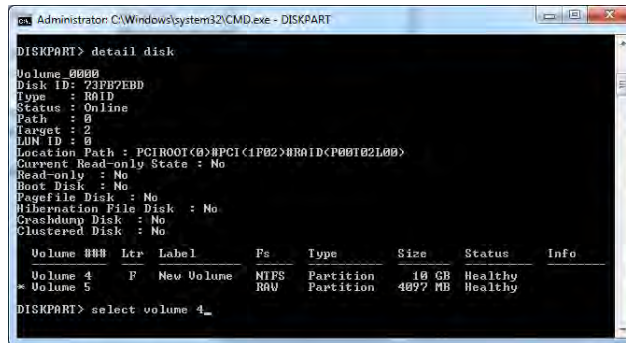

16. Type the following, depending on the format of the SSD.

- For **MBR** formatted SSDs: “**set id=84 override**” (the id must be set to 84).
- For **GPT** formatted SSDs: “**set id=D3BFE2DE-3DAF-11DF-BA40-E3A556D89593**”.

```

Administrator: C:\Windows\system32\CMD.exe - DISKPART
Status : Online
Path : 0
Target : 2
LUN ID : 0
Location Path : PCIROOT(0)#PCI(1F02)#RAID(P00T02L00)
Current Read-only State : No
Read-only : No
Boot Disk : No
Pagefile Disk : No
Hibernation File Disk : No
Crashdump Disk : No
Clustered Disk : No

  Volume ###  Ltr  Label        Fs      Type        Size     Status      Info
  -----
  Volume 4          F  New Volume  NTFS    Partition   10 GB    Healthy
  * Volume 5          RAW    Partition   4097 MB  Healthy

DISKPART> select volume 4

Volume 4 is the selected volume.

DISKPART> set id=84 override

DiskPart successfully set the partition ID.

DISKPART> _
  
```

17. The message “**DiskPart successfully set the partition ID.**” will appear.

18. Close the CMD window.

*Figure 6 - 51*  
Diskpart - Set id=

19. Go the **Windows** control panel and double-click **Administrative Tools (System and Security)**> **Computer Management** > **Storage** > **Disk Management**.
20. The disk partition should read **Healthy Hibernation Partition**.

Figure 6 - 52  
Computer Management  
(Healthy Hibernation Partition)

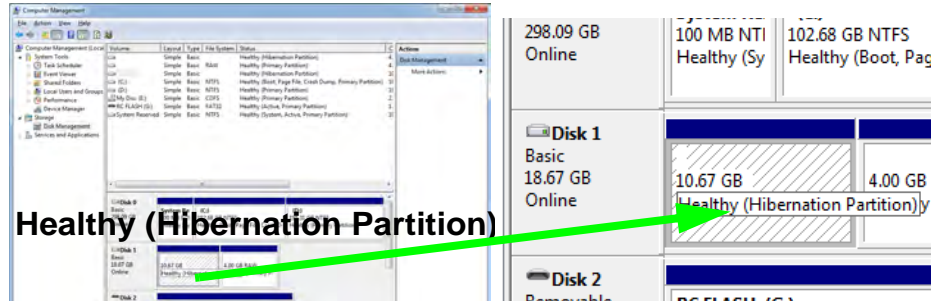

21. Restart the computer.
22. Install the driver (see below).

### Intel® Rapid Start Technology Driver Installation

1. Insert the *Device Drivers & Utilities + User's Manual* disc into the CD/DVD drive.
2. Click **Option Drivers** (button).
3. Click **6.Install Rapid Start Driver > Yes**.
4. Click **Next > Next > Yes > Next > Next**.
5. Click **Finish** to restart the computer.

## Sound Blaster Cinema EQ

Install the **Sound Blaster Cinema EQ** to allow you to configure the audio settings to your requirements for the best performance in games, music and movies.

### Sound Blaster Cinema EQ Installation

1. Insert the *Device Drivers & Utilities + User's Manual* disc into an attached DVD drive.
2. Click **Option Drivers** (button).
3. Click **7.Install SBCinema AP > Yes**.
4. Choose the setup language and click **Next**.
5. Click **Yes** to accept the license.
6. Click **Next > Full Installation** (button).
7. Click **Next > Finish** to restart the computer.



#### Creative Software AutoUpdate

Run the application from the shortcut in the Apps screen and make sure you are connected to the internet, then click **Next** and follow the on screen instructions to update the software.



### Sound Blaster Cinema & HDMI

Note that the Sound Blaster Cinema audio effects do not apply to audio generated through an HDMI connection.

## Sound Blaster Cinema Application

Run the **Sound Blaster Cinema** control panel from the notification area of the taskbar (or from the item in the Apps menu). Click on the tabs to access the any of the control panel menus.

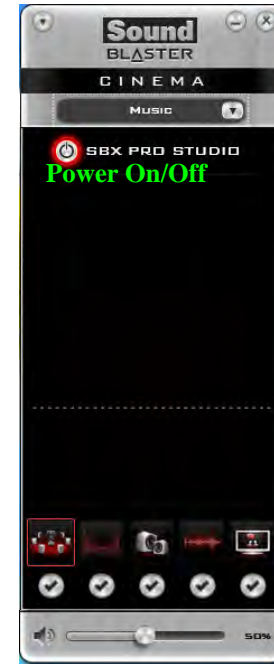
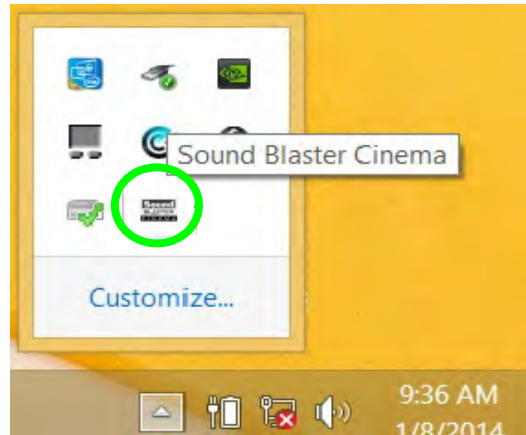

*Figure 6 - 53*  
**Sound Blaster Cinema**  
**(Taskbar Notification Area Icon & Menu)**



## Sound Blaster Cinema Settings

Sound Blaster Cinema selects the **built-in speakers** by default and this setting may cause some sound quality issues when using headphones. To **adjust the settings for headphones** do the following:

1. Run the **Sound Blaster Cinema** application.
2. Select **Settings** from the menu.
3. Select **Headphones** from the drop-down menu (you can adjust the slider for crossover frequency).
4. Click **OK** and close the application.



*Figure 6 - 54*  
Sound Blaster Cinema  
Select Headphones



**Settings**

You can use the drop down menu to use pre-sets for **Music**, **Movie** or **Games**. Alternatively you can use a **Custom** setting.

**Sound Blaster Cinema Controls**

Each control has an **On/Off** button to allow you to enable/disable the control, and most controls feature a slider to adjust the levels.

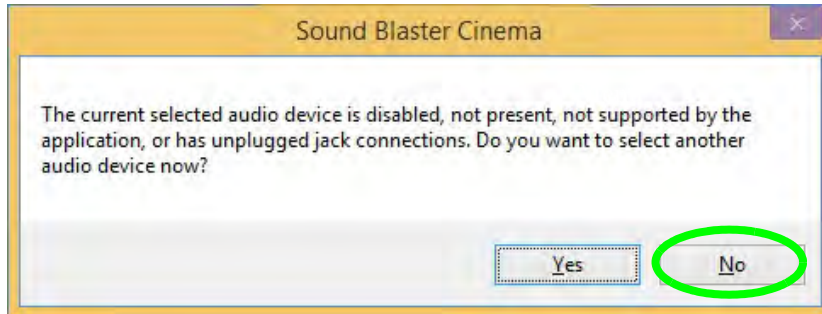

*Figure 6 - 55*  
**Sound Blaster Cinema Controls**

- **Surround:** Provides virtual sound channels to control the level of immersion.
- **Crystalizer:** Enhances audio to make it sound livelier.
- **Bass:** Enhances the bass level of the sound system.
- **Smart Volume:** Minimizes sudden volume changes to avoid the need for constant adjustment.
- **Dialog Plus:** Enhances dialogue levels for movies etc.

## Sound Blaster Cinema & HDMI

1. When you connect an HDMI display to the HDMI-Out port, the Sound Blaster Cinema controls will be disabled.
2. A warning box will pop-up and will prompt “...***Do you want to select another audio device now?***”.
3. Click **No** to continue using the HDMI audio output from your external display (do not attempt to select another audio device when connected to the external HDMI display).



*Figure 6 - 56*  
**Sound Blaster  
Cinema HDMI  
Display Warning**



### Compatible Adapters

For a list of compatible display and audio adapters check the Intel website, or your distributor/supplier.

## Wireless Display

Wireless Display uses your Wireless LAN module/WLAN Bluetooth Combo module (**you need to make sure that your video adapter/display device is compatible with your particular WLAN/Combo module**) in conjunction with a compatible video adapter/display device (purchased separately) to allow you to display the contents of the notebook display on another display (e.g. HDTV), without the need to have cables stretching across a room.

You can use the wireless display to play games, browse the internet, display videos or photo slide shows on your TV/external display without using HDMI or A/V cables.

Before configuring Wireless Display you will need to set up your compatible adapter with your display/speakers. Connect the adapter using an HDMI or A/V cable and turn on the display (or in the case of speakers connect them to the wireless speaker adapter with the cables provided with the adapter), and then set the display to the appropriate input channel (see the documentation supplied with your compatible adapter/display for full details).

**Note that no driver or application is required for wireless display in Windows 8.1.**

## Wireless Display Configuration

1. Note that no driver or application is required for wireless display in **Windows 8.1**.
2. Go the **Charms Bar**, select **Devices**.
3. Click **Project**.
4. Click **Add a wireless display**.

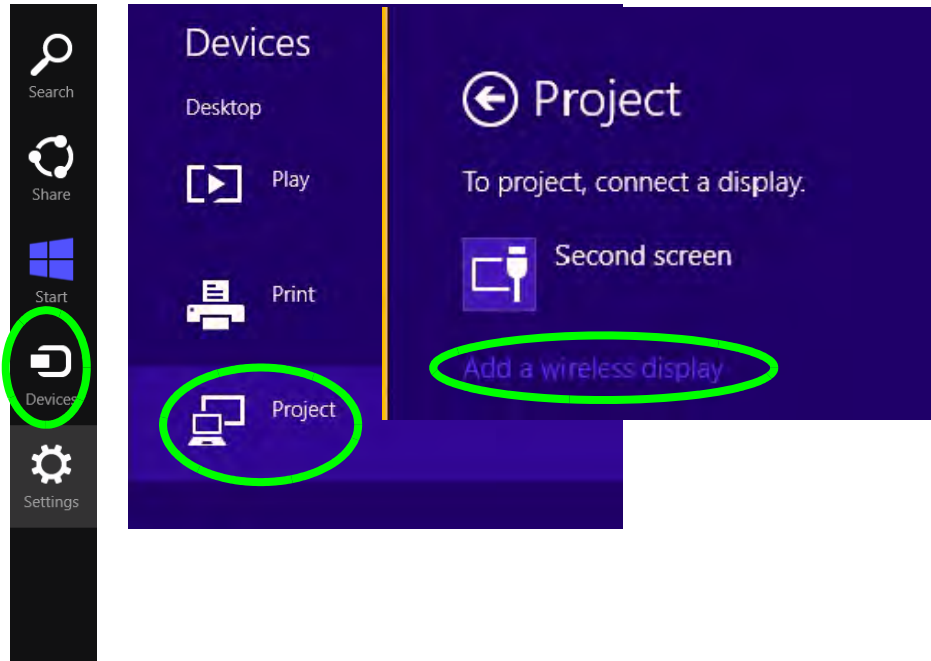

*Figure 6 - 57*  
**Add a Wireless Display**

- The system will then search for compatible display devices (**this may take up to 60 seconds** so allow time for this to complete).

*Figure 6 - 58*  
**Searching For Devices**

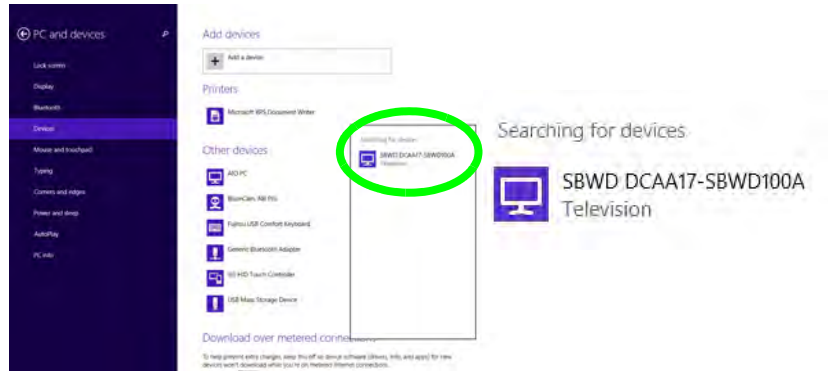

- Double-click any detected display device in the list.
- You may then need to input a pin number for the device to which you are connecting.
- Click **Next**.

*Figure 6 - 59*  
**Enter PIN**

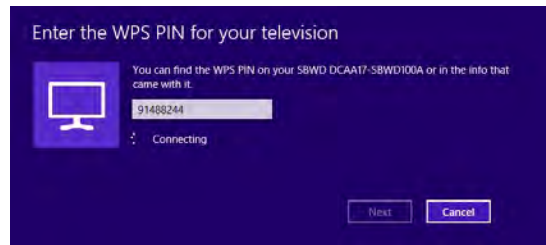

9. The display will then connect (for specific settings for your display see the documentation supplied with your compatible adapter/display for full details).
10. To disconnect from the display you can select it in **PC and Devices > Devices** and click **Remove Device > Yes**; or go to the **Project** menu (Charms Bar > Devices) and click **Disconnect**.

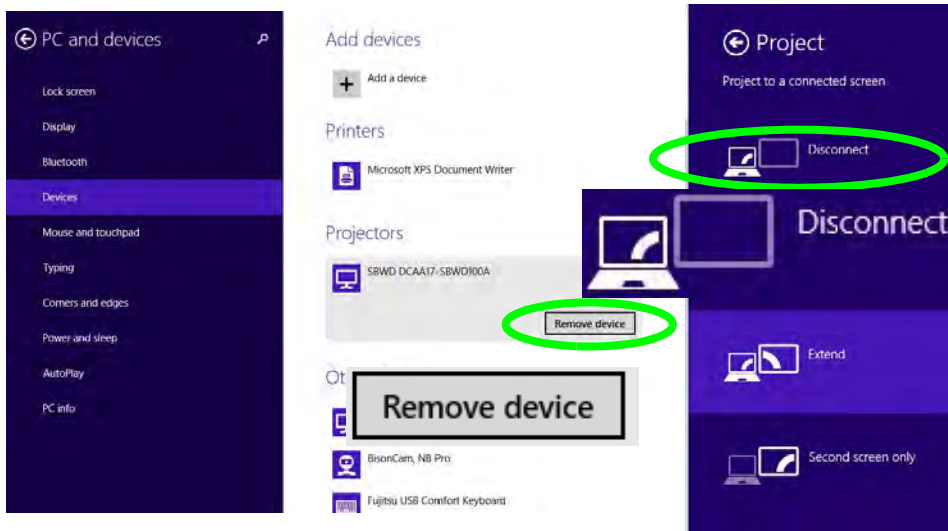

*Figure 6 - 60*  
**Remove Device/  
 Disconnect**

## 3G Module

**(For Model A/C Computers Only)**

If you have included an **optional UMTS/HSPDA+** based 3G Module (Universal Mobile Telecommunications System or High Speed Packet Access) module (see *“Communication” on page D - 4* for specification details) in your purchase option, **you do not require a driver/application installation for Windows 8.1**. Follow the instructions overleaf to install the USIM card (which will be provided by your service provider), and then **use the Charms Bar Wireless icon to access the 3G network** in the same manner as the WLAN (see page **6 - 78**).



### Important Notice

If your purchase option includes both Wireless LAN and 3G modules, then the appropriate antennas will be installed. Note that In order to comply with FCC RF exposure compliance requirements, the antenna must not be co-located or operate in conjunction with any other antenna or transmitter.

### Important Notice - 3G & Bluetooth/Wireless LAN Modules

In order to comply with FCC regulations you should NOT operate the 3G module and the Bluetooth/Wireless LAN modules at the same time as this may disrupt radio frequency, and cause interference. When the 3G module is powered on, make sure that the Bluetooth/Wireless LAN modules are powered off.



### 3G Module USIM Card Installation

Follow the instructions below to install the USIM card (which will be provided by your service provider).

1. Turn **off** the computer, and turn it over.
2. Remove the battery (see [“Removing the Battery” on page 6 - 4](#)).
3. Insert the USIM card (at the rear of the battery compartment) as illustrated below until it clicks fully into position, and replace the battery.

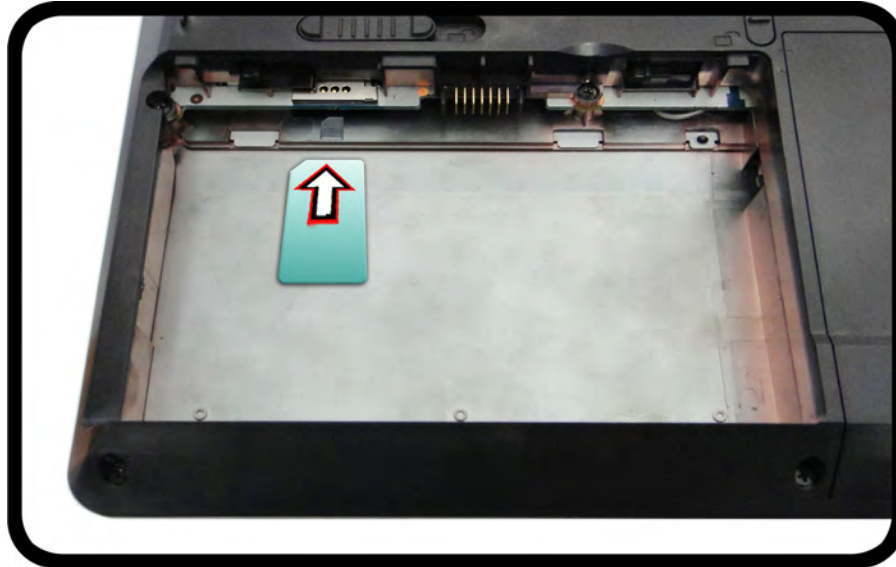

#### Power Safety Warning

Before you undertake any installation procedures, make sure that you have turned off the power, and disconnected all peripherals and cables (including telephone lines). It is advisable to also remove your battery in order to prevent accidentally turning the machine on.

#### USIM Card Orientation

Note that the USIM card's readable side (with the gold-colored contacts) should face upwards as illustrated.

*Figure 6 - 61*  
**USIM Card Insertion**

### 3G Configuration in Windows

You can configure a 3G connection as below, however make sure the system is not in Airplane Mode before configuration begins.

#### Charms Bar

1. Go to the **Charms Bar**.
2. Select **Settings** and then click the **WiFi icon** (it should read **Available** under the icon and **Airplane mode** should be **Off**).
3. A list of available access points will appear under Mobile Broadband.

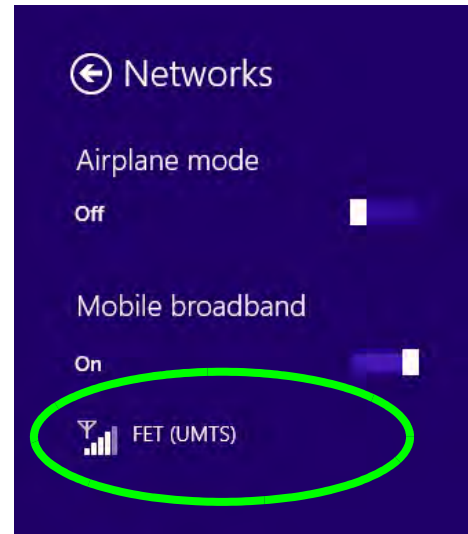
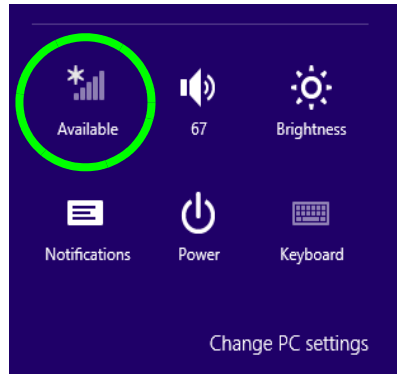
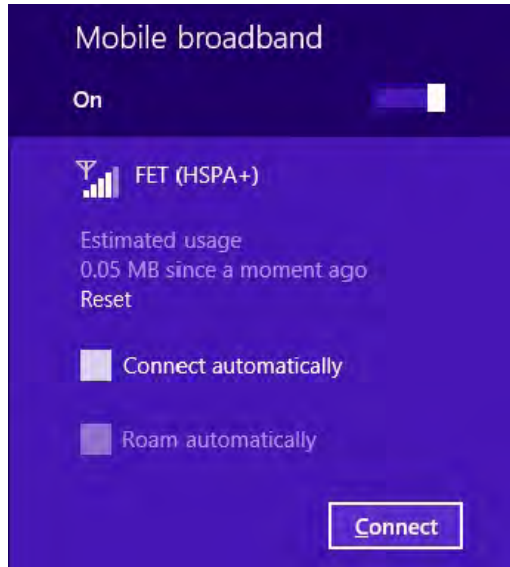

Figure 6 - 62

**Networks  
Mobile Broadband**

- Any 3G service provider (connection information is usually stored on the USIM card) will appear under Mobile Broadband.
- Double-click any connection icon under Mobile Broadband (or click and then click **Connect**).



*Figure 6 - 63*  
**Mobile Broadband**  
**(Connect)**

- The system will connect to your network.
- A **Connected** will appear alongside the 3G connection (click the connection to view the timer which indicates your connected time for the current session).

## Modules



### Wireless Device Operation Aboard Aircraft

The use of any portable electronic transmission devices aboard aircraft is usually prohibited.

Make sure the system is in **Airplane Mode** if you are using the computer aboard aircraft.

8. You can then access the internet, download e-mail etc. as per any internet connection.
9. To disconnect you can select the connection and click **Disconnect** .

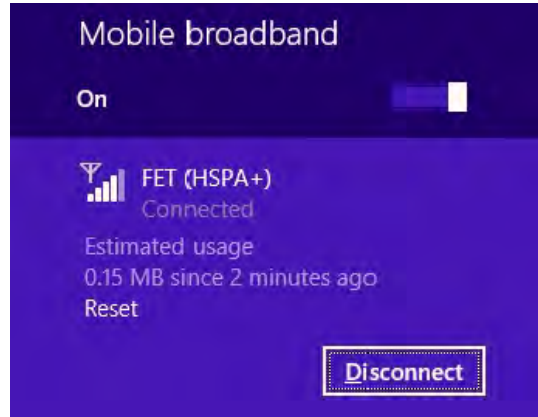

10. You need to either use **Airplane Mode**, or to **turn the Mobile Broadband module off** aboard aircraft.

*Figure 6 - 64*  
**Mobile Broadband  
(Disconnect)**

## EM820W 3G Module PIN Code & Power-Saving

Note that there may be some issues when a PIN Code is set for the EM820W 3G module (if you are unsure of your module version contact your distributor/supplier) in *Windows*, if Mobile Broadband has been turned off, and the system has resumed from a power-saving state. **To prevent any issues it is recommended that you simply do not enable a PIN for the EM820W 3G module.** The following provides instructions for disabling the PIN code; for specific instructions on resolving the issue where “Insert a SIM” appears in the connection see *“Resolving the “Insert a SIM” issue with the 3G Module (Windows 8.1)” on page 7 - 18.*

### Disabling a PIN code for a 3G Module

1. Go to the **Charms Bar**.
2. Click **Change PC Settings**.

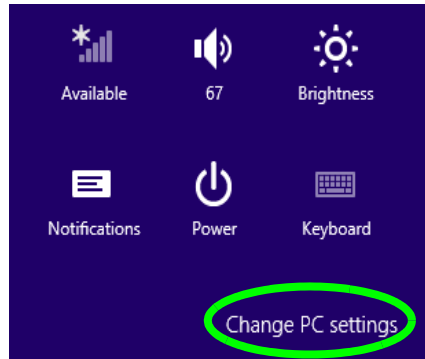

Figure 6 - 65  
Change PC Settings

3. Click **Network**.
4. Click the broadband connection under **Mobile Broadband**.
5. Scroll down to **Security** and click **Remove PIN**.
6. Enter the current PIN number and click **OK**.
7. **It is recommended that you do not Enable a PIN for the EM820W 3G module.**

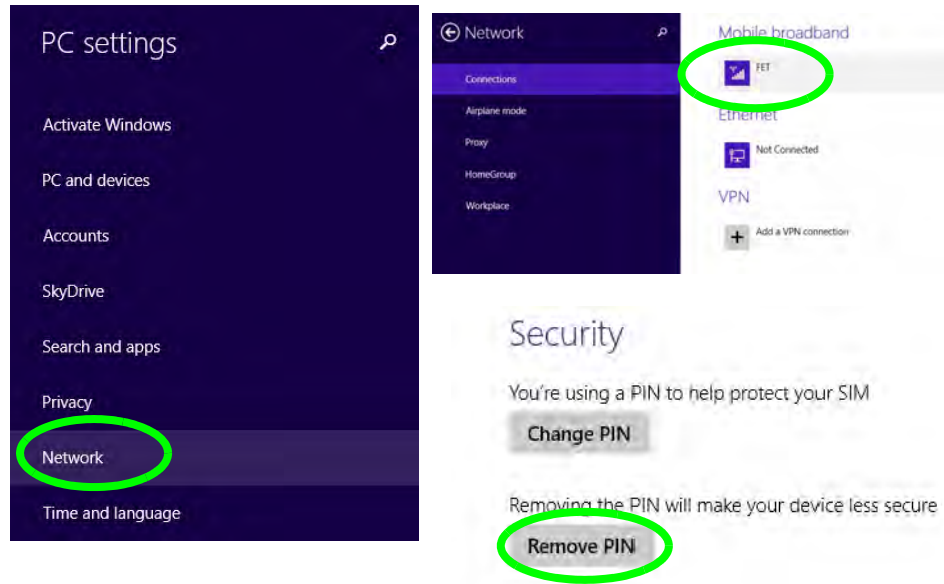

Figure 6 - 66  
Disable PIN

8. Click **Security** (tab) and click **Disable PIN**.

# Chapter 7: Troubleshooting

## Overview

Should you have any problems with your computer, before consulting your service representative, you may want to try to solve the problem yourself. This chapter lists some common problems and their possible solutions. This can't anticipate every problem, but you should check here before you panic. If you don't find the answer in these pages, make sure you have followed the instructions carefully and observed the safety precautions in the preface. If all else fails, talk to your service representative. You should also make a record of what happened and what remedies you tried.

Of course, if something goes wrong, it will happen at the most inconvenient time possible, so you should preview this section just in case. If, after you've tried everything, and the system still won't cooperate, try turning it off for a few minutes and then rebooting. You will lose any unsaved data, but it may start working again. Then call your service representative.

# Basic Hints and Tips

Many of the following may seem obvious but they are often the solution to a problem when your computer appears not to be working.

- **Power** - Is the computer actually plugged into a working electrical outlet? If plugged into a **power strip**, make sure it is actually working. Check the **LED Power Indicators** (see *“LED Indicators” on page 1 - 10*) to see the computer’s power status.
- **Connections** - Check all the **cables** to make sure that there are no **loose connections** anywhere.
- **Power Savings** - Make sure that the system is not in **Hibernate** or **Sleep** mode by pressing the keys configured in your *Power Options* (see *“Configuring the Power Buttons” on page 3 - 9*), the **Fn + F4** key combination, or power button to wake-up the system.
- **Brightness** - Check the brightness of the screen by pressing the **Fn + F8 and F9** keys to adjust the brightness (see *Table 1 - 6, on page 1 - 16*).
- **Display Choice** - Press **Fn + F7** to make sure the system is not set to “external only” display.
- **Boot Drive** - Make sure there are no **optical media and/or USB storage devices** in any connected drive.



## Backup and General Maintenance

- Always **backup** your important data, and keep copies of your OS and programs safe, but close to hand. Don't forget to note the **serial numbers** if you are storing them out of their original cases, e.g. in a CD wallet.
- Run **maintenance programs** on your hard disk and OS as often as you can. You may schedule these programs to run at times when you are not using your computer. You can use those that are provided free with your OS, or buy the more powerful dedicated programs to do so.
- Write down your passwords and keep them safe (away from your computer). This is especially important if you choose to use a **Boot** password for the SCU (see *“Security Menu” on page 5 - 12*).
- Keep copies of vital **settings files** such as network, dialup settings, mail settings etc. (even if just brief notes).



### Warranty

The CPU is not a user serviceable part. Opening this compartment, or accessing the CPU in any way, may violate your warranty.

# Viruses

- Install an **Anti-Virus** program and keep the **definitions file** (the file which tells your program which viruses to look for) up to date. New computer viruses are discovered daily, and some of them may seriously harm your computer and cause you to lose data. **Anti-Virus** programs are commercially available and the **definitions file updates** are usually downloadable directly from the internet.
- Be careful when opening e-mail from sources you don't know. **Viruses** are often triggered from within **e-mail attachments** so take care when opening any attached file. You can configure most **Anti-Virus** programs to check all **e-mail attachments**. **Note:** You should also beware of files from people you know as the virus may have infected an **address book** and been automatically forwarded without the person's knowledge.
- Keep a "**Bootable CD-ROM/DVD-ROM/USB storage device**" (this CD/DVD/USB device provides basic information which allows you to startup your computer) handy. You may refer to your OS's documentation for instructions on how to make one, and many **Anti-Virus** programs will also provide such a disk (or at least instructions on how to make one).

## Upgrading and Adding New Hardware/Software

- Do not be tempted to make changes to your **Windows Registry** unless you are very sure of what you are doing, otherwise you will risk severely damaging your system.
- Don't open your computer or undertake any repair or upgrade work if you are not comfortable with what you are doing.
- Read the **documentation**. We can assume, since you are reading this that you are looking at the computer's manual, but what about any new peripheral devices you have just purchased? Many problems are caused by the installation of new hardware and/or software. Always refer to the documentation of any new hardware and/or software, and pay particular attention to files entitled "**READ ME**" or "**READ ME FIRST**".
- When installing a new device always make sure the device is powered on, and in many cases you will need to restart the computer. Always check that all the cables are correctly connected.
- Make sure you have installed the **drivers** for any new hardware you have installed (latest **driver files** are usually available to download from vendor's websites).
- Thoroughly check any **recent changes** you made to your system as these changes may affect one or more system components, or software programs. If possible, go back and undo the change you just made and see if the problem still occurs.

## Troubleshooting

- Don't over complicate things. The less you have to deal with then the easier the source of the problem may be found; **Example** - if your computer has many devices plugged into its ports, and a number of programs running, then it will be difficult to determine the cause of a problem. Try disconnecting all of the devices and restarting the computer with all the peripheral devices unplugged. A process of elimination (adding and removing devices and restarting where necessary) will often find the source of a problem, although this may be time consuming.

## Problems and Possible Solutions



Problem	Possible Cause - Solution
<p>You turned on the <b>power</b> but it doesn't work.</p>	<p><i>Battery missing / incorrectly installed.</i> Check the battery bay, make sure the battery is present and seated properly (the design of the battery only allows it to go in one way). Make sure there's nothing interfering with the battery contacts.</p>
<p>The battery <b>LED power</b> indicator , is blinking orange.</p>	<p><i>Low Battery.</i> Plug in the DC power source. If the computer doesn't start up immediately, turn it off then on again.</p>
<p>You are <b>losing battery power</b> too quickly.</p>	<p><i>The system is using too much power.</i> If your OS has a <i>Power Options</i> scheme (see "<a href="#">Power Plans</a>" on page 3 - 5) check its settings. You may also be using a <i>peripheral device/USB device</i> that is drawing a lot of power.</p>
<p>Actual <b>battery operating time</b> is shorter than expected.</p>	<p><i>The battery has not been fully discharged before being recharged.</i> Make sure the battery is fully discharged and recharge it completely before reusing (see "<a href="#">Battery Information</a>" on page 3 - 14).</p> <p><i>Power Options have been disabled.</i> Go to the <b>Control Panel</b> in <i>Windows</i> and re-enable the options.</p> <p><i>A peripheral device/USB device is consuming a lot of power.</i> Turn off/remove the unused device to save power.</p>

## Troubleshooting

Problem	Possible Cause - Solution
The computer feels <b>too hot</b> .	<p>Make sure the computer is properly ventilated and the Vent/Fan intakes are not blocked. If this doesn't cool it down, put the system into <b>Hibernate</b> mode or turn it off for an hour. Make sure the computer isn't sitting on a thermal surface (see "<a href="#">Overheating</a>" on page 1 - 20). Make sure you're using the correct adapter.</p> <p>Make sure that your notebook is completely powered off before putting it into a travel bag (or any such container). Putting a notebook which is powered on in a travel bag may cause the Vent/Fan intakes to be blocked.</p>
Nothing appears on screen.	<p><i>The system is in a power saving mode.</i> Toggle the sleep/resume key combination, <b>Fn + F4</b> (see "<a href="#">Configuring the Power Buttons</a>" on page 3 - 9).</p> <p><i>The screen controls need to be adjusted.</i> Toggle the screen control key combinations <b>Fn + F8/F9</b>. If you're connected to an external monitor, make sure it's plugged in and turned on. You should also check the monitor's own brightness and contrast controls.</p> <p><i>The computer is set for a different display.</i> Toggle the screen display key combination, <b>Fn + F7</b>. If an external monitor is connected, turn it on.</p> <p><i>The <b>screen saver</b> is activated.</i> Press any key or touch the <b>TouchPad</b>.</p>
No image appears on the <b>external monitor</b> I have plugged in and powered on.	<p><i>You haven't installed the video driver and configured it appropriately from the <b>Control Panel</b>.</i> See <a href="#">Appendix C</a> for instructions on installing and configuring the video driver.</p>

Problem	Possible Cause - Solution
You forget the <b>boot password</b> .	<i>If you forget the password, you may have to discharge the battery of the CMOS. Contact your service representative for help.</i>
 <p><b>Password Warning</b></p> <p>If you choose to set a boot password, <b>NEVER</b> forget your password. The consequences of this could be serious. If you cannot remember your boot password you must contact your vendor and you may lose all of the information on your hard disk.</p>	
The sound cannot be heard or the <b>volume is very low</b> .	<i>The volume might be set too low. Check the volume control in the <b>Volume Control Panel</b> in the Windows notification area, or use the key combination <b>Fn + F5</b> and <b>F6</b> (see <b>“Function Keys &amp; Visual Indicators” on page 1 - 16</b>) to adjust.</i>
The CD/DVD <b>cannot be read</b> .	<i>The CD/DVD is dirty. Clean it with a CD/DVD cleaner kit.</i>
The CD/DVD <b>tray will not open</b> when there is a disc in the tray.	<i>The CD/DVD is not correctly placed in the tray. Gently try to remove the disc using the eject hole (see <b>“Loading Discs” on page 2 - 3</b>).</i>
The <b>DVD regional codes</b> can no longer be changed.	<i>The code has been changed the maximum <b>5</b> times. See <b>“DVD Regional Codes” on page 2 - 5</b>.</i>
<b>Unwelcome numbers</b> appear when typing.	<i>Num Lock is turned <b>ON</b> (see <b>“LED Indicators” on page 1 - 10</b>).</i>

## Troubleshooting

Problem	Possible Cause - Solution
 <h3>Other Keyboards</h3> <p>If your keyboard is damaged or you just want to make a change, you can use any standard USB keyboard. The system will detect and enable it automatically. However special functions/hot keys unique to the system's regular keyboard may not work.</p>	
The <b>system freezes</b> or the screen goes dark.	<i>The system's power saving features have timed-out.</i> Use the AC/DC adapter, press the sleep ( <b>Fn + F4</b> ) key combination, or press the power button if no LEDs are lit.
The system never goes into a <b>power saving mode</b> .	Power Options features are not enabled. Go to the <b>Windows</b> Power Options menu and enable the features you prefer (see <b><i>"Power-Saving States" on page 3 - 7</i></b> ). Make sure you have enabled <b>Hibernate</b> mode from the control panel.
The <b>Wireless LAN/Bluetooth</b> modules cannot be detected.	<i>The modules are off as the computer is in <b>Airplane Mode</b>.</i> Check the LED indicator  to see if it is in <b>Airplane Mode</b> (see <b><i>"LED Indicators" on page 1 - 10</i></b> ). Use the <b>Fn + F11</b> key combination to toggle <b>Airplane Mode</b> on/off (see <b><i>Table 1 - 6, on page 1 - 16</i></b> ).
The <b>PC Camera</b> module cannot be detected.	<i>The module is off.</i> Press the <b>Fn + F10</b> key combination in order to enable the module (see <b><i>"Function Keys &amp; Visual Indicators" on page 1 - 16</i></b> ). Run the camera application to view the camera picture.



Problem	Possible Cause - Solution
The <b>Wireless LAN/Bluetooth</b> modules cannot be configured.	The driver(s) for the module(s) have not been installed. Make sure you have installed the driver for the appropriate module (see the instructions for the appropriate module in <i>“Wireless LAN Module” on page 6 - 21</i> and/or <i>“Bluetooth &amp; WLAN Combo Module” on page 6 - 45</i> ).
A file cannot be copied to/from a connected <b>Bluetooth</b> device.	<i>The transfer of data between the computer and a Bluetooth enabled device is supported <b>in one direction only (simultaneous data transfer is not supported)</b>.</i> If you are copying a file from your computer to a Bluetooth enabled device, you will not be able to copy a file from the Bluetooth enabled device to your computer until the file transfer process has been completed
I cannot obtain high speed Bluetooth data transfer.	<i>To obtain high speed Bluetooth data transfer take into account the following:</i> <ul style="list-style-type: none"> <li>• To achieve high speed transfer speeds, <b>both devices must support high speed data transfer</b> (i.e both the computer and the Bluetooth compatible device you are connecting to).</li> <li>• Check your Bluetooth compatible device’s documentation to confirm it supports high speed data transfer, and for configuration information.</li> </ul>
The <b>fingerprint reader has problems scanning fingers.</b>	<i>When fingers are wet or sweaty the software application may have difficulty reading a scanned finger.</i> Make sure your fingers are clean and dry when attempting to scan them across the sensor for detection.
<b>No sound</b> can be heard through an <b>HDMI</b> connected display.	<i>You have not configured the HDMI audio output.</i> See <i>“HDMI Audio Configuration” on page C - 33.</i>

## Troubleshooting

Problem	Possible Cause - Solution
<p>The <b>Sound Blaster</b> audio controls don't work when the system is connected to an <b>external display through an HDMI cable</b>.</p>	<p><i>Note that Sound Blaster Audio will be disabled when you are connecting to an external display through an HDMI connection. See <a href="#">“Sound Blaster Audio &amp; HDMI” on page C - 35</a>.</i></p>

Problem	Possible Cause - Solution
<p>I have used <b>Update Driver</b> in <b>Device Manager (Unknown device &gt; Other Devices)</b> to try and install the <b>Airplane Mode</b> driver. <b>Windows</b> encountered a problem in attempting to update the driver, and a <b>yellow exclamation mark</b> appears in <b>Device Manager</b> against the <b>Unknown device</b>.</p>	<p><i>It is very important that the drivers are installed in the order indicated in Chapter 4 (which is the numbered installation order on the Device Drivers &amp; Utilities + User's Manual disc). This issue can occur when drivers are manually installed, and not in the correct order.</i></p> <p>If you have attempted to <b>Update Driver</b> from the <b>Device Manager</b> control panel and have encountered problems, then use the method below to correct this:</p> <p><b>To correct this problem:</b></p> <ol style="list-style-type: none"> <li>1. Go to the <b>Programs and Features (Programs)</b> control panel in <b>Windows</b>.</li> <li>2. Select any installed Airplane Mode driver item (e.g. Insyde Airplane Mode HID Mini-Driver), and click <b>Uninstall/Change</b> to uninstall the current driver.</li> <li>3. Restart the computer.</li> <li>4. Insert the <i>Device Drivers &amp; Utilities + User's Manual disc</i> and click <b>Install Drivers</b> (button).</li> <li>5. Double-click the <b>Airplane Driver</b> item in the menu.</li> <li>6. Follow the instructions to install the correct driver (you will need to restart the computer as part of the installation process).</li> </ol>

## Troubleshooting

Problem	Possible Cause - Solution
<p>I have connected a <b>Bluetooth mouse</b> but it <b>loses the Bluetooth connection</b> and no longer responds after a short period of inactivity.</p>	<p><i>This is an issue with this mouse type and the Intel Wireless 7260 WLAN and Bluetooth combo module series. To resolve this issue do the following:</i></p> <ol style="list-style-type: none"><li>1. Go to the <b>Device Manager</b> control panel in <b>Windows</b>.</li><li>2. Click the arrow alongside <b>Bluetooth</b> to expand the menu if required.</li><li>3. Double-click <b>Intel(R) Wireless Bluetooth(R) 4.0 + HS Adapter</b>.</li><li>4. Click the <b>Power Management</b> tab.</li><li>5. Make sure that the check box alongside <b>“allow the computer to turn off this device to save power”</b> doesn't have a check alongside it.</li><li>6. Click <b>OK</b> and close the control panel.</li></ol>

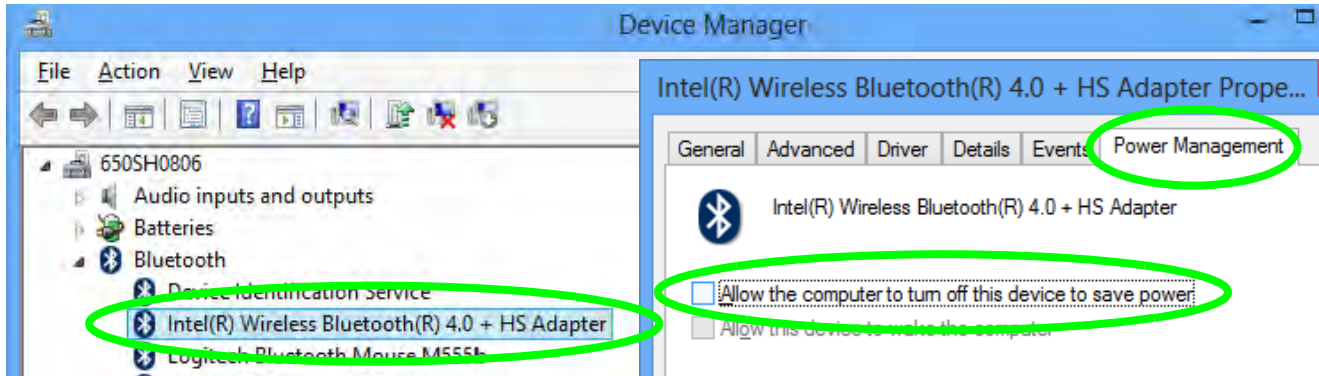

Figure 7 - 1 - Device Manager (Bluetooth)

Problem	Possible Cause - Solution
<p>When using a <b>Bluetooth headset the audio appears to be mono</b> and not stereo.</p>	<p><i>This is a common issue with Bluetooth headsets. To resolve this issue do the following (you will need to <b>repeat this procedure after every boot up, restart, or when the system resumes from hibernation</b>):</i></p> <ol style="list-style-type: none"> <li>1. Go to the <b>Devices &amp; Printers</b> control panel in <b>Windows</b>.</li> <li>2. Double-click the Bluetooth headset.</li> <li>3. Click <b>Connect</b> to complete the stereo connection.</li> </ol> <p><b>OR</b></p> <ol style="list-style-type: none"> <li>1. Go to the <b>Sound</b> control panel in <b>Windows</b>.</li> <li>2. Right-click (in the <b>Playback</b> tab) the Bluetooth Stereo Audio device (the default device is <b>Headset</b>).</li> <li>3. Click <b>Connect</b> to complete the stereo connection.</li> </ol>

# EM820W 3G Module PIN Code & Power-Saving

Note that there may be some issues when a PIN Code is set for the EM820W 3G module (if you are unsure of your module version contact your distributor/supplier) in *Windows*, if Mobile Broadband has been turned off, and the system has resumed from a power-saving state. **To prevent any issues it is recommended that you simply do not enable a PIN for the EM820W 3G module.** The following provides instructions for disabling the PIN code.

### Disabling a PIN code for a 3G Module

1. Go to the **Charms Bar**.
2. Click **Change PC Settings**.

7

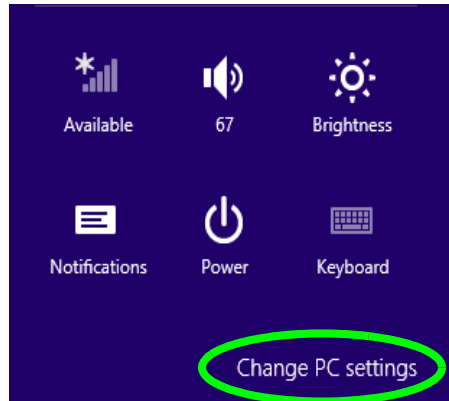

Figure 7 - 2 - Change PC Settings

3. Click **Network**.
4. Click the broadband connection under **Mobile Broadband**.
5. Scroll down to **Security** and click **Remove PIN**.
6. Enter the current PIN number and click **OK**.
7. **It is recommended that you do not Enable a PIN for the EM820W 3G module.**

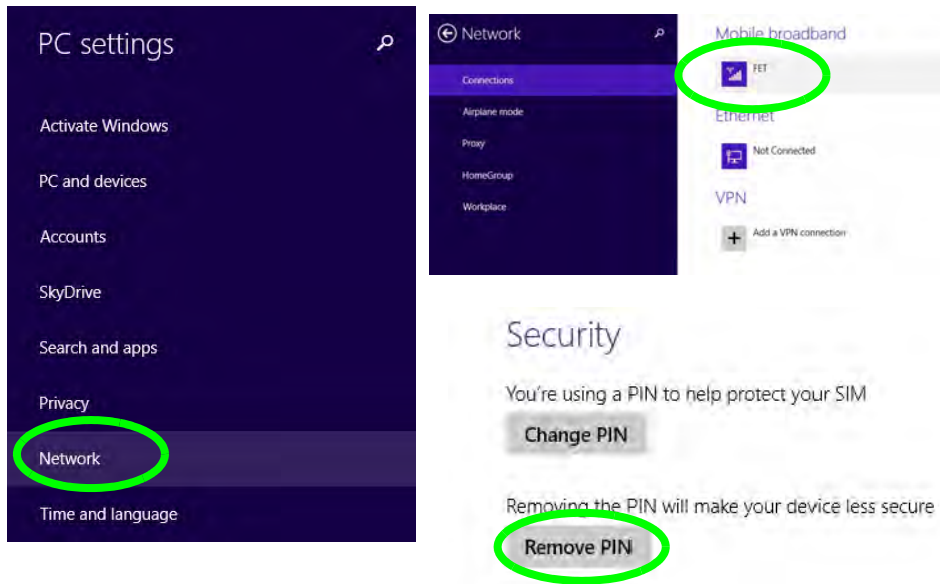

Figure 7 - 3 - Disable PIN

### Resolving the “Insert a SIM” issue with the 3G Module (Windows 8.1)

1. If a PIN was set for the EM820W 3G module, you have then switched **Mobile broadband off** (or put the system in **Airplane Mode**) in **Networks**, and the system has just resumed from a power-saving state the following error may occur.
2. On resuming from the power-saving state the standard procedure would be to go to **Networks** in the **Charms Bar** and turn on Mobile broadband.
3. Go to the **Charms Bar**.
4. Select **Settings** and you will then note that the **WiFi icon** will read **Unavailable**.
5. Standard procedure would be to click the connection and enter the PIN number to unlock the connection.
6. In this instance you will note that the **Mobile broadband** connection will read **Insert a SIM**.
7. In this case you will need to **restart the computer**.
8. After system restart you can then connect to the Mobile Broadband as normal.
9. **To fully resolve this issue it is recommended that you do not Enable a PIN for the EM820W 3G module.**







# Appendix A: Interface (Ports & Jacks)







## Overview

The following chapter will give a quick description of the ports & jacks which allow your computer to communicate with external devices, connect to the internet etc.



# Ports and Jacks

Item	Description
<p>Card Reader</p> 	<p>The card reader allows you to use the following digital storage cards:</p> <p>MMC (MultiMedia Card) / RSMMC SD (Secure Digital) / Mini SD / SDHC / SDXC MS (Memory Stick) / MS Pro / MS Duo</p> <p>Push the card into the slot and it will appear as a removable device.</p>
<p>DC-In Jack</p> 	<p>Plug the supplied AC/DC adapter into this jack to power your computer.</p>
<p>External Monitor (VGA) Port</p> 	<p>This port allows you to connect an external monitor, or Flat Panel Display, to get dual video or simultaneous display on the LCD and external monitor/FPD.</p>
<p>e-SATA / USB 3.0 Combo Port</p> 	<p>This <b>e-SATA (external Serial Advanced Technology Attachment)</b> port allows you to plug-in external Serial ATA hard drives. This port also serves as a USB 3.0 port.</p>

A

Item	Description
HDMI-Out Port 	The HDMI-Out ( <b>High-Definition Multimedia Interface</b> ) port is an audio/video connector interface for transmitting uncompressed digital streams. This allows you to connect an external monitor, TV or Flat Panel Display etc. as a display device by means of a HDMI cable. <b>Note that HDMI carries both audio and video signals</b> (see <a href="#">“HDMI Audio Configuration” on page C - 33</a> ).
Headphone-Out Jack 	<b>Headphones</b> or <b>speakers</b> may be connected through this jack. <b>Note:</b> Set your system’s volume to a reduced level before connecting to this jack.
Microphone-In Jack 	Plug an external microphone in to this jack to record on your computer.
RJ-45 LAN Jack 	This port supports LAN (Network) functions. <b>Note:</b> Broadband (e.g. ADSL) modems usually connect to the LAN port.
S/PDIF-Out Jack 	This S/PDIF ( <b>Sony/Philips Digital Interface Format</b> ) Out Port allows you to connect your DVD-capable PC to a Dolby AC-3 compatible receiver for “5.1” or ‘dts’ surround sound.
Security Lock Slot 	To prevent possible theft, a Kensington-type lock can be attached to this slot. Locks can be purchased at any computer store.

## Interface (Ports & Jacks)

Item	Description
<p data-bbox="169 227 360 247">USB 2.0/1.1 Ports</p>  <p data-bbox="193 314 336 334">USB 3.0 Port</p> 	<p data-bbox="432 227 1466 398">These USB (<b>Universal Serial Bus</b>) 2.0 compatible ports (USB 2.0 is fully USB 1.1 compliant) are for low-speed peripherals such as keyboards, mice or scanners, and for high-speed peripherals such as external HDDs, digital video cameras or high-speed scanners etc. Devices can be plugged into the computer, and unplugged from the computer, without the need to turn the system off (if the power rating of your USB device is 500mA or above, make sure you use the power supply which comes with the device).</p> <p data-bbox="432 434 1466 514">The USB 3.0 ports are denoted by their blue color (and is not operational under DOS); USB 2.0 ports are colored black. USB 3.0 will transfer data much faster than USB 2.0, and is backwards-compatible with USB 2.0.</p>

A



# Appendix B: Control Center

## Overview

The following chapter will give a quick description of the functions of the **Control Center**. The **Control Center** gives quick access to frequently used controls, power management features and enables you to quickly turn modules on/off. Click the **Control Center** icons to toggle the appropriate function, or hold the mouse button down and move the dial control where applicable. Certain functions will automatically be adjusted when a power mode is selected. The **Control Center** in *Windows 8.1* works under the **Desktop** App and not under the Start screen.



### Control Center Access

To run the Control Center press the **Fn + Esc** key combination, Control Center Launch button , or double-click the icon  in the notification area of the taskbar.

Close the Control Center by clicking the  close icon in the top right of the panel (move the cursor onto the top right corner of the panel to highlight it).

The Control Center Launch button  toggles the Control Center on/off.

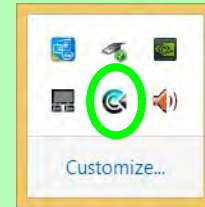

Figure B - 1 - Control Center

## Control Center

### Power Modes

You can set a **Power Mode** by clicking the appropriate icon at the top of the **Control Center**. Each power mode will affect the Power Conservation Mode, Airplane Mode, Power Plan and PC camera power etc.

You can click a **Control Center** icon to set an overall power mode and then click individual icons in the **Control Center** to power on/off the Touchpad and PC camera.







Modes		Quiet	Power Saving	Performance	Entertainment
Icon					
Power Plan		Balanced	Power Saver	High Performance	Balanced
Power Conservation Mode		Balance	Energy Star	Performance	Balance
PC Camera		ON	OFF	ON	ON
TouchPad		ON	ON	ON	ON
Airplane Mode		OFF	ON	OFF	OFF

Table B - 1- Power Modes

### Control Center Menus

The Control Center contains 3 menu headings (**System Program**, **Device** and **Gaming**) under the Power Modes. Click the menu headings and then click any of the buttons outlined on the following pages.



Figure B - 2 - Control Center Menus

B

## Control Center

### Power Status (System Program)

The **Power Status** icon will show whether you are currently powered by the battery, or by the AC/DC adapter plugged in to a working power outlet. The power status bar will show the current battery charge state.

### Brightness (System Program)

The **Brightness** icon will show the current screen brightness level. You can use the slider to adjust the screen brightness or the **Fn + F8/F9** key combinations, or use the **Fn+ F2** key combination to turn off the LED backlight (press any key to turn it on again).

### Volume (System Program)

The **Volume** icon will show the current volume level. You can use the slider to adjust the Volume or the **Fn + F5/F6** key combinations, or use the **Fn+ F3** key combination to mute the volume.

### Power Conservation (System Program)

This system supports **Energy Star** power management features that place computers (CPU, hard drive, etc.) into a low-power sleep modes after a designated period of inactivity (see *[“Power Conservation Modes” on page 3 - 12](#)*). Click either the **Performance**, **Balanced** or **Energy Star** button.

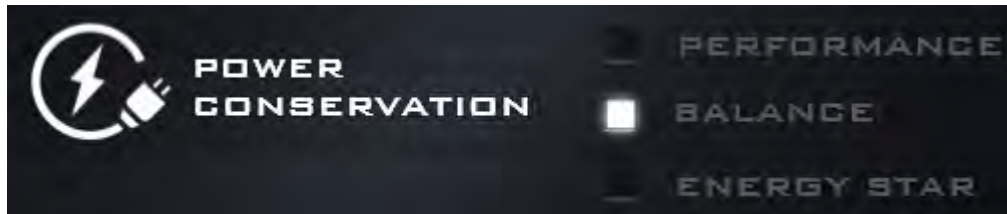



**Sleep Button (System Program)**

Click either the **Hibernate** or **Sleep** buttons to have the computer enter the selected power-saving mode when the **Fn + F4** key combination is pressed (see *“Power-Saving States” on page 3 - 7*).

**Display Switch (System Program)**

Click the **Display Switch** button to access the menu (or use the  + **P** key combination) and select the appropriate attached display mode.

**Time Zone (System Program)**

Clicking the **Time Zone** button will access the **Date and Time Windows** control panel.

**Desktop Background (System Program)**

Clicking the **Desktop Background** button will allow you to change the desktop background picture.

**TouchPad/PC Camera (Device)**

Click either of these buttons to toggle the TouchPad or camera module's power status. The icon will appear dimmed when it is off. Note that the power status of the camera module is also effected by the **Power Mode** selected (see *Table B - 1, on page B - 2*).

**Backlight Keyboard (Device)**

Click the button to adjust the keyboard backlight brightness.

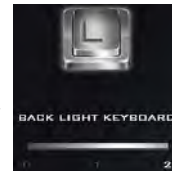

## Control Center

### Left Windows Key (Gaming)



Click **Disable** to disable the Windows Key on the left side of the keyboard. This may be useful if you are using the keyboard for gaming and wish to avoid accidentally triggering menus with the Windows Key.

### Fan Speed (Gaming)

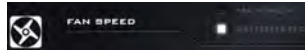

The fan speed will adjust itself automatically to control the heat of the CPU. However you can adjust the setting to maximum if you prefer.

### Headphone (Gaming)



The headphones may be set for different effects using this menu.

### Caps Lock/Scroll Lock/ Number Lock/Airplane Mode

Click the button to toggle the appropriate lock mode and Airplane Mode.



# Appendix C: Video Driver Controls

The basic settings for configuring the LCD are outlined in *“Video Features” on page 1 - 33*.

## Video Driver Installation

Make sure you install the drivers in the order indicated in *Table 4 - 1, on page 4 - 3*. Insert the *Device Drivers & Utilities + User’s Manual* disc and click *Install Drivers* (button).

### Video (VGA)

1. Click **2.Install VGA Driver > Yes**.
2. Click **Next > Yes > Next > Next**.
3. Click **Finish** to restart the computer.

### NVIDIA Video (VGA)

1. Click **3.Install NVIDIA VGA Driver > Yes**.
2. Click **AGREE AND CONTINUE** (button) to accept the terms of the license agreement.
3. Click **Next**.
4. Click **Close** to complete the installation.



### Video Card Options

Note that card types, specifications and drivers are subject to continual updates and changes. Check with your distributor/supplier for the latest details on video cards supported (see *“Video Adapter Options” on page D - 3*).



### iGPU or dGPU

Note the NVIDIA control panel refers to **High-performance NVIDIA processor** (which is the discrete GPU) and **Integrated graphics** (which is the integrated GPU).

## Microsoft Hybrid Graphics

Most notebook computers come with either a **discrete** or **integrated** graphics solution.

**Discrete** graphics solutions feature a dedicated Graphics Processing Unit (GPU) which are capable of playing games, watching HD video or running GPU-based applications. However computers with discrete graphics solutions tend to be heavy in power consumption, and slightly larger in size in order to incorporate the dedicated discrete GPU.

**Integrated** graphics solutions usually feature memory sharing technology to help save power consumption and allow for longer battery life. However computers with integrated graphics solutions will not usually run games, HD video or GPU-based applications without severe limitations.

**Microsoft Hybrid Graphics** is a seamless technology designed to get best performance from the graphics system while allowing longer battery life, without having to manually change settings. Thus when an application is run that requires extra performance or quality, then the system will run the discrete GPU (dGPU); when the system does not require such enhanced performance it will let the integrated (iGPU) handle it.

### How the Technology Works

When the system is powered up and is displaying just the desktop, the dGPU will be powered off. In this case the system is running in the same way as a system without a discrete graphics solution. However when an application that requires use of the dGPU is run (e.g, a game or HD Video), the dGPU is powered on and takes over the processing duties. If the program is closed, then the dGPU will be powered back down again until required.



#### Customization Options

Although **Microsoft Hybrid Graphics** is completely seamless to the user, NVIDIA also allow customization options within the control panel (see [“Customization Options” on page C - 28](#)).

# Intel® Dynamic Video Memory Technology

Intel® DVMT automatically and dynamically allocates as much (up to **1748MB**) system memory (RAM) as needed to the integrated video system (**the video driver must be installed**). DVMT returns whatever memory is no longer needed to the operating system.

# Intel® HD Graphics Control Panel

Advanced video configuration options are provided by the **Intel® HD Control Panel**. To access the control panel see below and overleaf:

1. Click the **Intel® HD Graphics Control Panel** icon in the **Apps** screen.

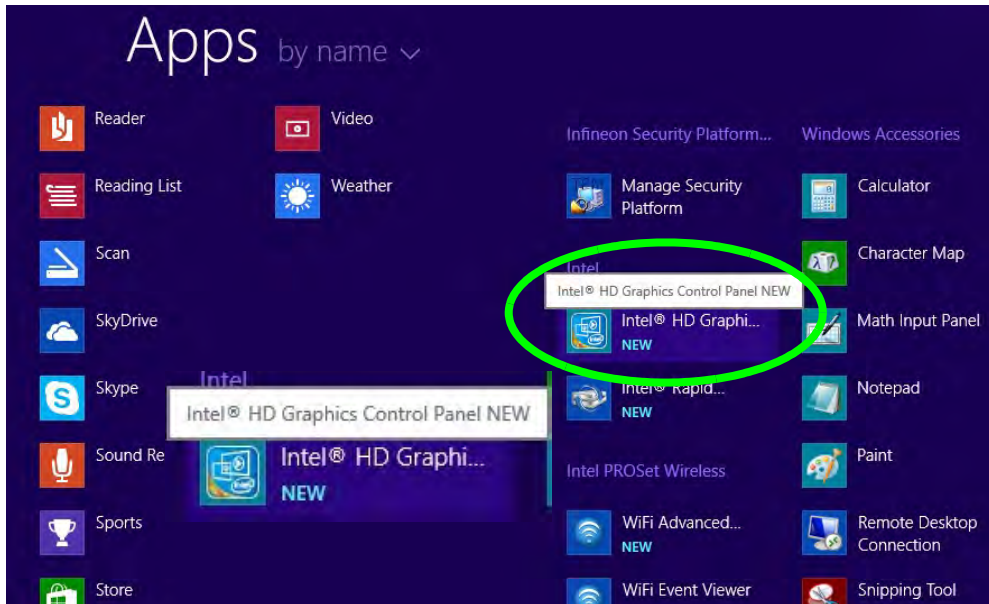

(see over)

*Figure C - 1*  
**Apps Screen**  
**Intel® HD Graphics**  
**Control Panel**

## Video Driver Controls

OR

2. Right-click the **Desktop** and select **Graphics Properties** from the menu.

OR

3. Click **Advanced settings** in the **Screen Resolution** control panel in **Windows**.

4. Click the **Intel(R) HD Graphics Control Panel** tab and click **Graphics Properties** (button).

5. Double-click the **Intel(R) HD Graphics** control panel in the **Windows Control Panel**.

*Figure C - 2*  
**Intel® HD Graphics  
Control Panel**

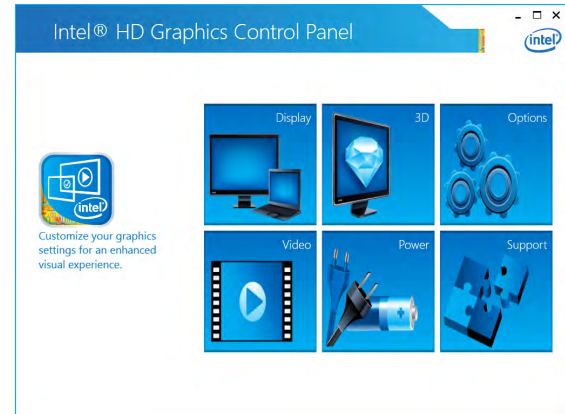
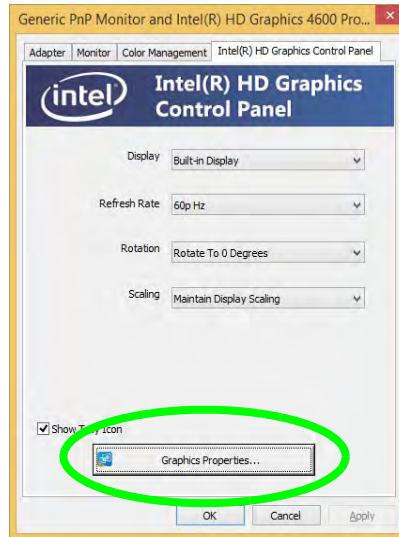



You may make changes to any of the graphics properties by clicking the appropriate menu panel and adjusting the settings on the right.

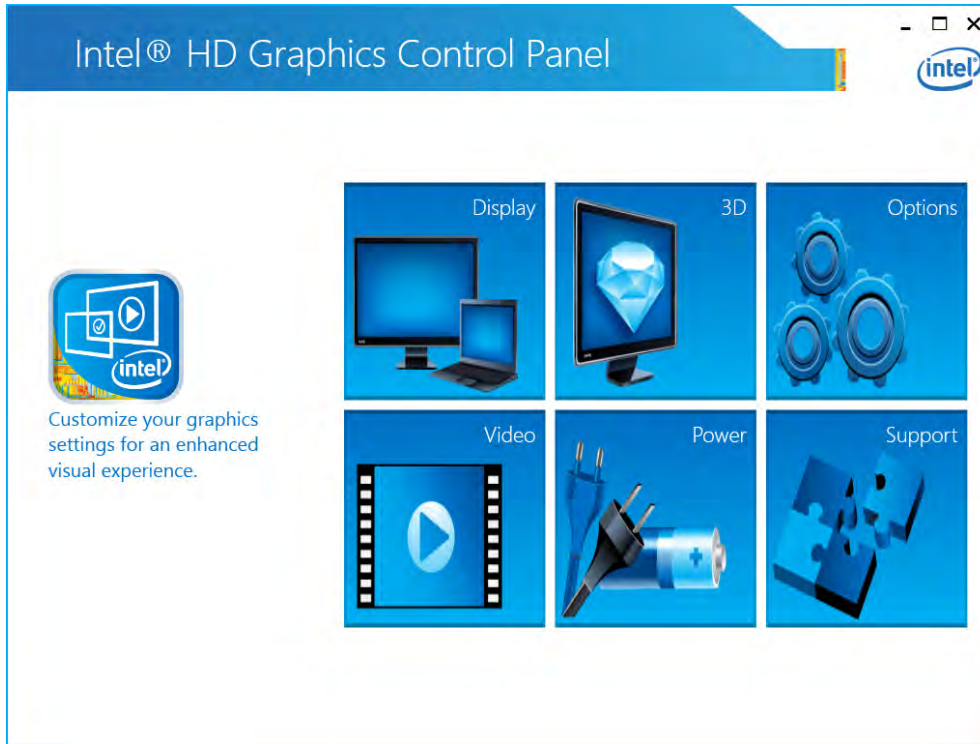
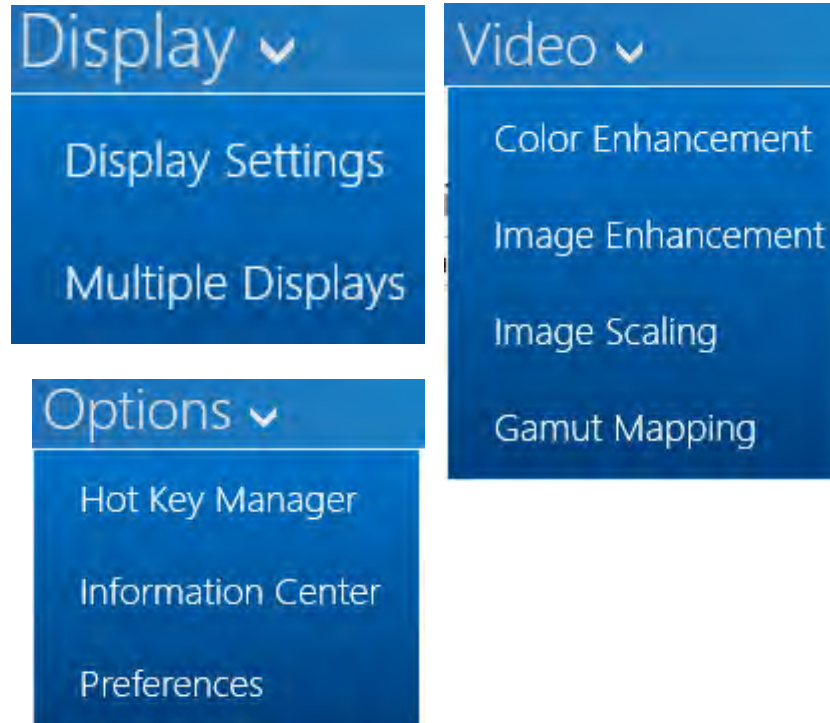

*Figure C - 3*  
**Intel® HD Graphics  
Control Panel**

## Video Driver Controls

### Sub-Menus

Some of the menu panels will also have sub-menus (in the top left corner of the menu alongside the icon ) to display further configuration options.



*Figure C - 4*  
**Intel® HD Graphics  
Control Panel  
Sub-Menus**

## Display

Click either **Display Settings** or **Color** to make display adjustments, including configuration for any attached external displays.

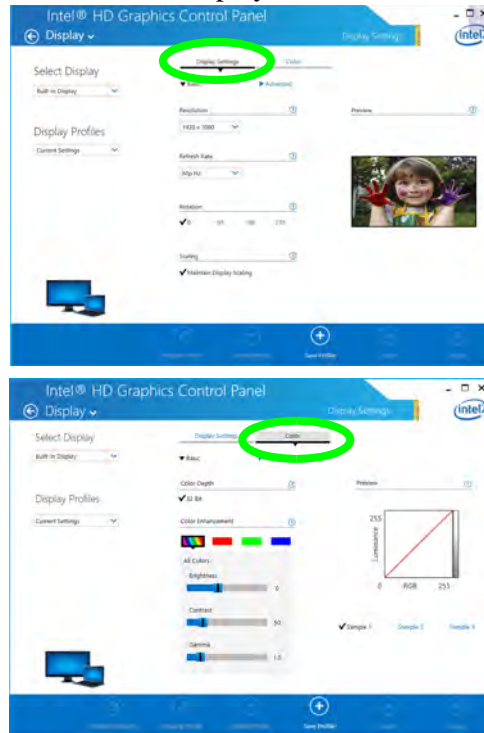

### Multiple Display

At least one other display must be attached in order to view multiple display selection options.

*Figure C - 5*  
Intel® HD Graphics  
Control Panel  
Display Settings

## Video Driver Controls



### Multiple Display

At least one other display must be attached in order to view multiple display selection options.

*Figure C - 6*  
**Intel® HD Graphics Control Panel**  
**Display Settings -**  
**Multiple Displays**

Click the **Display** menu at the top of the screen to display the sub-menus. The **Multiple Displays** menu allows you to configure the display mode of any attached displays (see *“Attaching Other Displays” on page C - 20*).

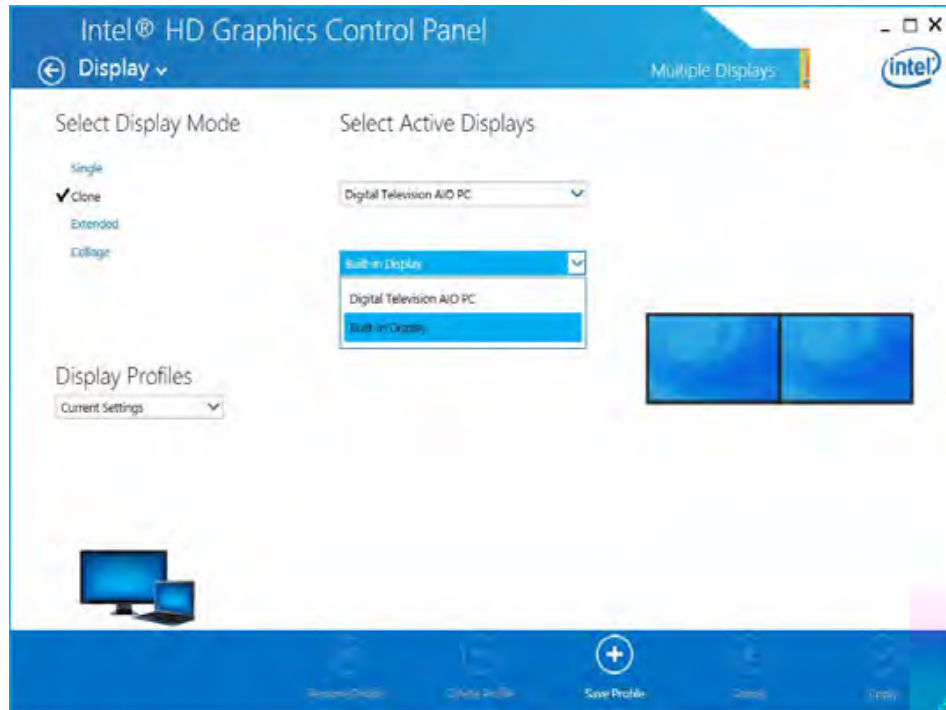

### 3D

This menu allows you to choose how 3D images are displayed. **Quality** displays the most detail, **Balanced** provides better computer performance with good quality and **Custom** allows you to configure the **Anisotropic Filtering** and **Vertical Sync** features to your preferences. Click **Apply** to save changes.

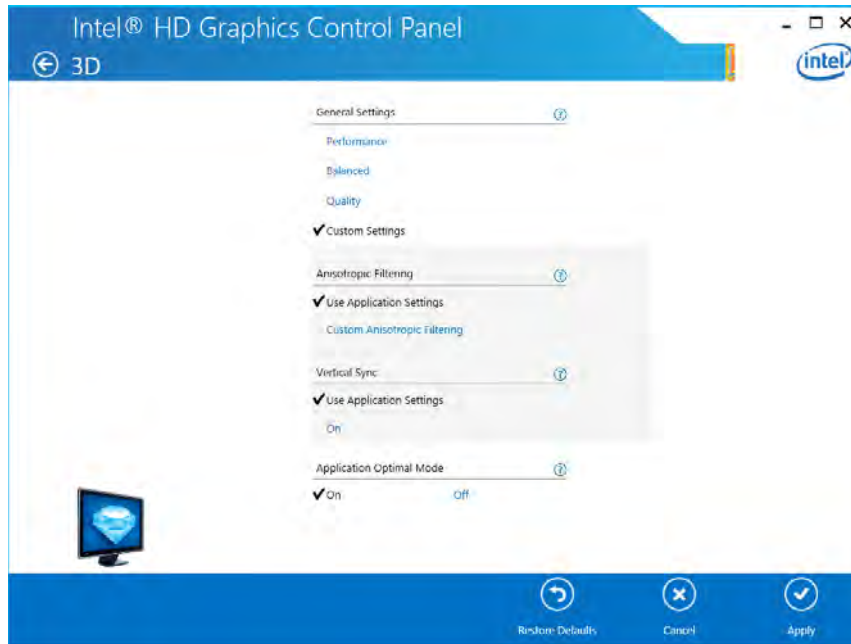

*Figure C - 7*  
Intel® HD Graphics  
Control Panel 3D

### Options

**Options** allows you to **Customize Hot Keys** (for opening the application, rotating the display, scaling etc.,) to your preferences. Click **Apply** to save changes.

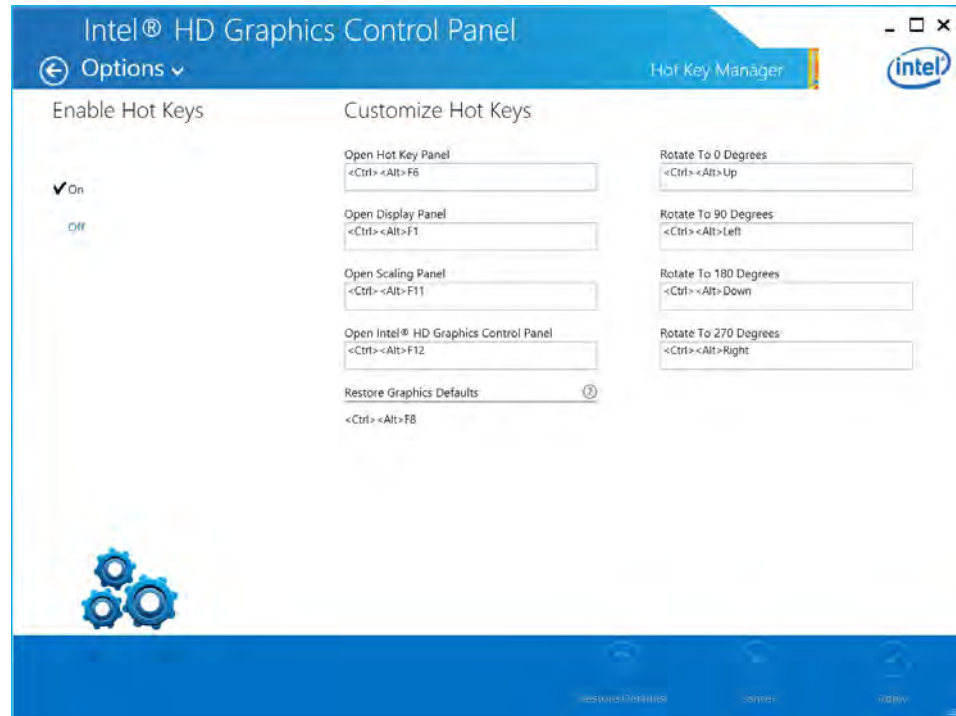

*Figure C - 8*  
**Intel® HD Graphics  
Control Panel  
Options**

Click the **Options** menu at the top of the screen to display the sub-menus. The **Information Center** provides details on **System Information**, the **Built-In Display** and any **attached displays**.

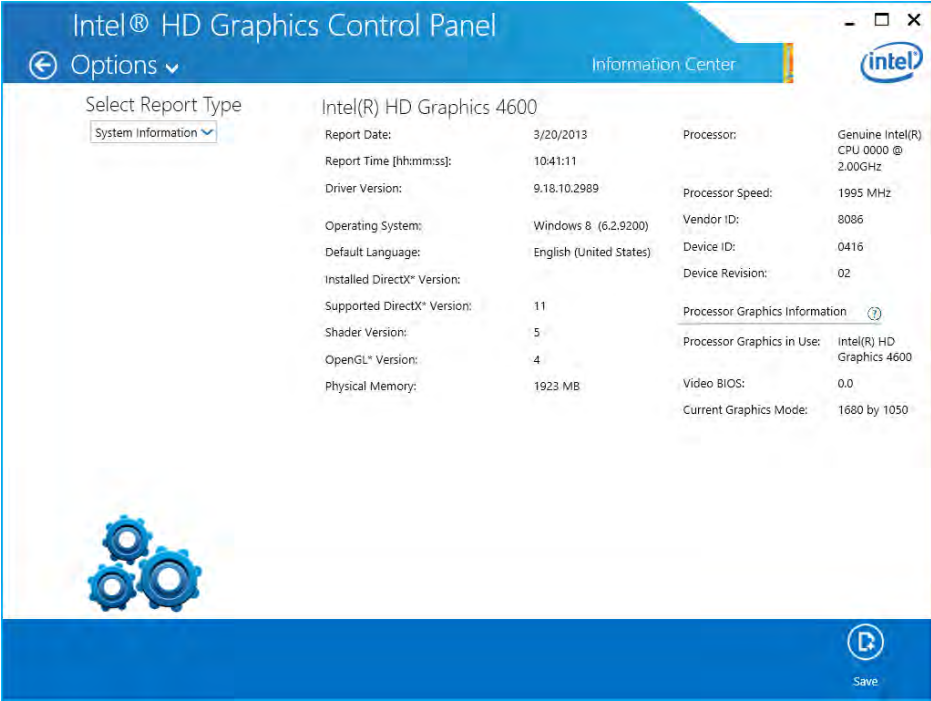



### Preferences

Go to the **Preferences** sub-menu in Options to configure the preferences for the Intel® HD Graphics Control Panel.

Make sure you turn Tray Icon On to display the Intel® HD Graphics Control Panel icon in the notification area of the taskbar (as below).

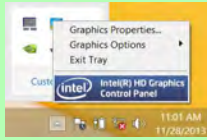

*Figure C - 9*  
**Intel® HD Graphics Control Panel Options - Information Center**

## Video Driver Controls

### Video

The **Video Profiles** menu allows you to brighten or darken movies, or to switch to vivid colors. Click **Basic** or **Advanced** to adjust the video settings based on the **Application Settings** or **Driver Settings**. The **Preview** image will display a sample image using the current settings. You can **Save Profile** and name the Profile to recall the settings at any time. Click **Apply** to save changes.

*Figure C - 10*  
**Intel® HD Graphics Control Panel Video (Basic - Application Settings)**

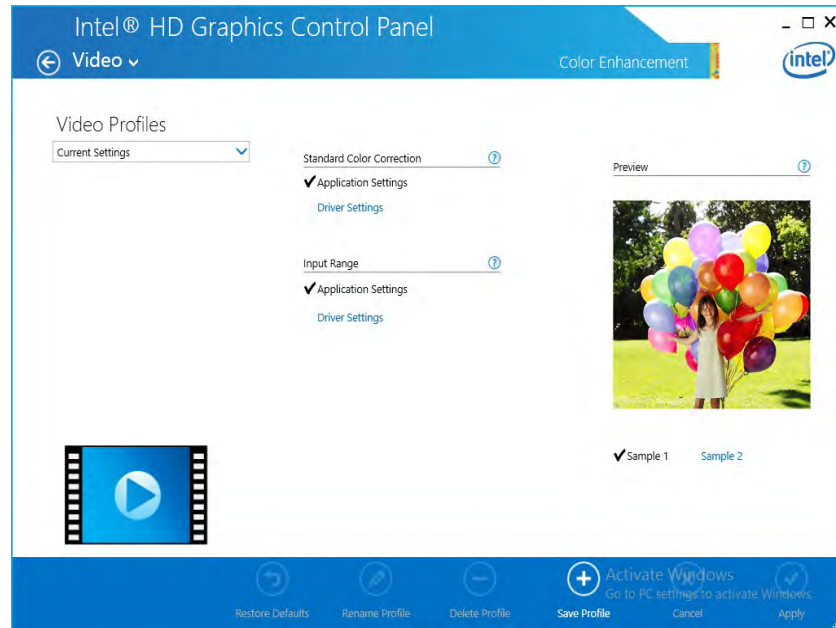



Click the **Video** menu at the top of the screen to display the sub-menus. The **Image Enhancement** menu allows you to adjust the **Sharpness** and **Skin Tone Enhancement**. Click **Apply** to save changes.

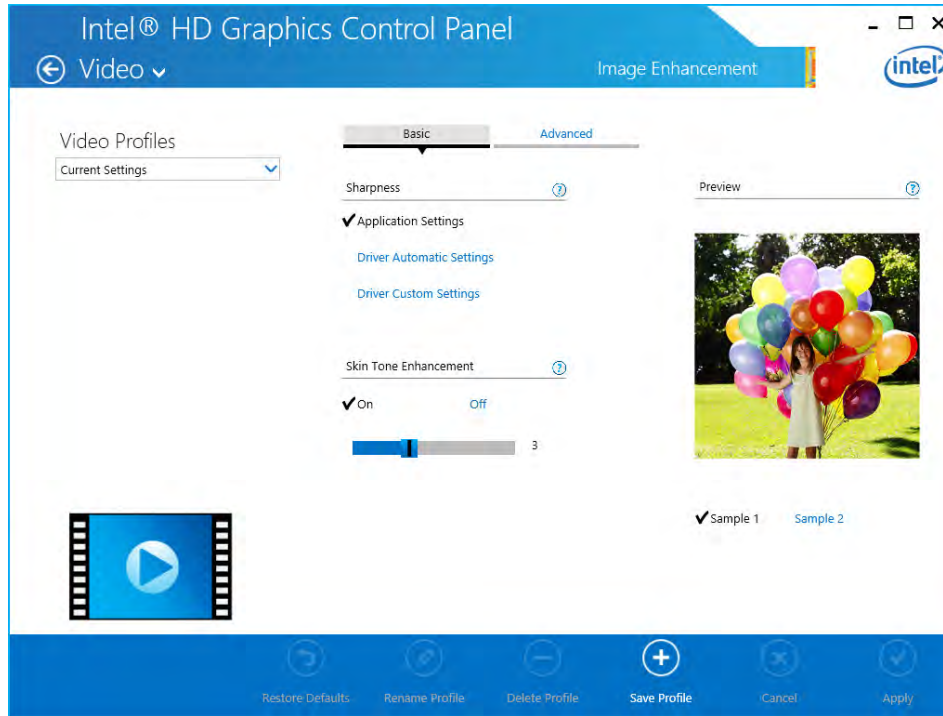
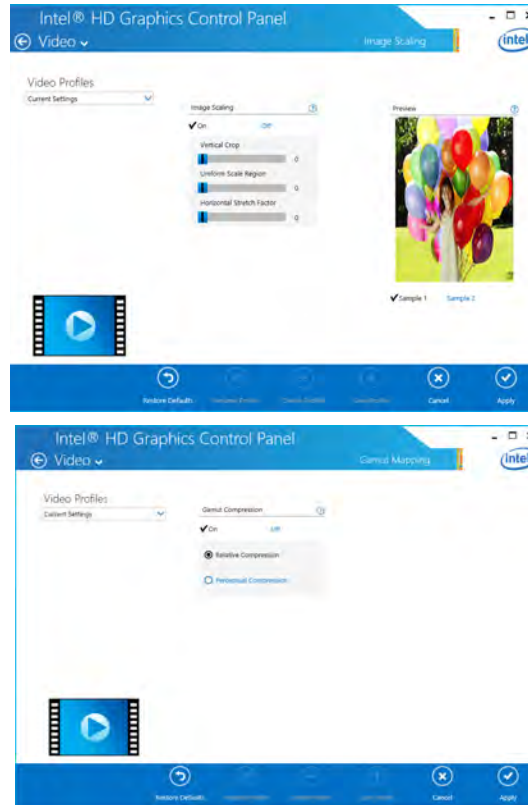

*Figure C - 11*  
**Intel® HD Graphics  
Control Panel Video  
Image  
Enhancement Basic**

## Video Driver Controls

The **Image Scaling** and **Gamut Mapping** menus allow you to adjust these items.

*Figure C - 12*  
**Intel® HD Graphics  
Control Panel Video  
Image Scaling &  
Gamut Mapping**



## Power

Choose a Power Plan for when the computer is **Plugged in** or **On battery**. When turned on, the **Display Power Saving Technology** (which adjusts the backlight intensity) battery settings may be adjusted by means of the slider towards **Maximum Quality** or **Maximum Battery**. Click on **Apply** to save changes.

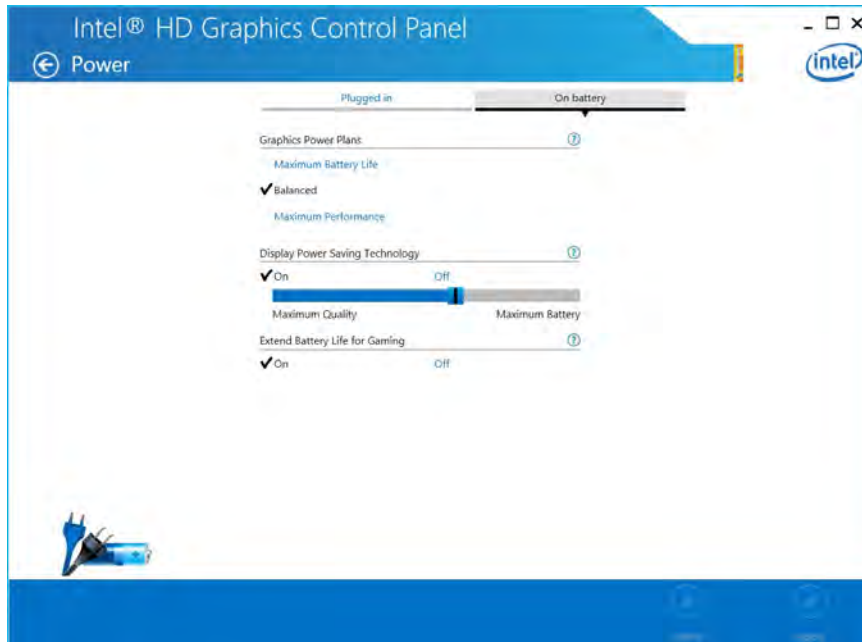

*Figure C - 13*  
**Intel® HD Graphics  
Control Panel Power  
(Battery Settings)**

### Support

Click **Support** and select an item from the menus to bring up the help and support topics. You will need to be connected to the Internet to access the key resource links.

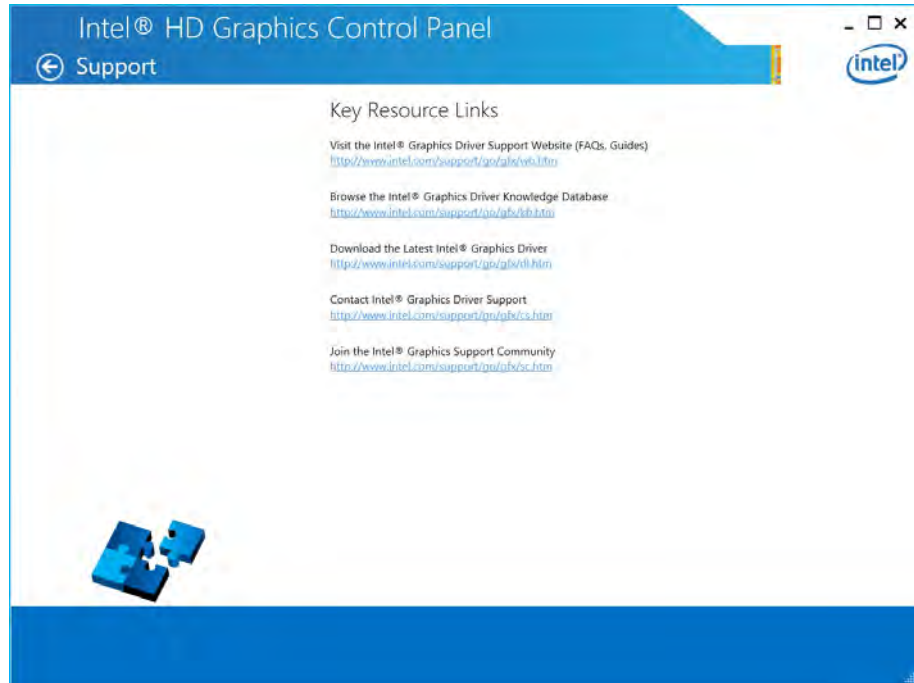

*Figure C - 14*  
**Intel® HD Graphics  
Control Panel  
Support**

## Display Devices & Options

Note that you can use external displays connected to the HDMI-Out port and/or external monitor port. See your display device manual to see which formats are supported.



### Attaching Displays

When you first attach an external display you may find that the desktop does not occupy the full screen area. Use either the display's auto adjust/configure controls, or the Intel(R) HD Graphics Control Panel to configure the full screen display.

Display Mode	Description
Single Display	One of the connected displays is used as the display device ( <b>PC screen only</b> or <b>Second screen only</b> ).
Clone/Duplicate	Both connected displays output the same view and may be configured independently
Extended / Extend	Both connected displays are treated as separate devices, and act as a virtual desktop
Collage	A number of connected displays are combined into a single unified higher resolution for larger screen sizes

*Table C - 1*  
**Display Modes**



### Multiple Display

At least one other display must be attached in order to view **Multiple Display** selection options.

## Attaching Other Displays

### To Clone Displays:

1. Attach your external display to the display port/mini display port/HDMI-Out port, and turn it on.
2. Go to the **Intel(R) HD Graphics Control Panel** control panel and click **Display > Multiple Displays** (sub-menu).
3. Click **Clone** from the **Select Multiple Display Mode** menu.
4. Click **Apply**, and **OK** to confirm the settings change.
5. You can select the **displays to be used** from the **Select Active Displays** menu.



*Figure C - 15*  
**Display > Multiple Displays (Clone)**

**To Enable Extended Mode:**

1. Attach your external display to the display port/mini display port/HDMI-Out port, and turn it on.
2. Go to the **Intel(R) HD Graphics Control Panel** control panel and click **Display > Multiple Displays** (sub-menu).
3. Click **Extended** from the **Select Multiple Display Mode** menu.
4. Click **Apply**, and **OK** to confirm the settings change.



Click the appropriate monitor icon and drag it to match the physical arrangement you wish to use (e.g. the secondary display may be extended left/right/above/below the primary display).

Click **Display Settings** to make any adjustments required.



### Display Settings Extended Desktop

You can have different Colors, Screen Area and Monitor Refresh Rates for each display device **provided your monitor can support them**.

You can drag the monitor icons to match the physical layout of your displays. Icons and programs may also be dragged between the displays.

*Figure C - 16*  
**Display > Multiple Displays (Extended)**

## Video Driver Controls



### Collage Mode

Collage mode is used to combine a number of displays into a single unified higher resolution for larger screen sizes,.

### To Enable Collage Mode:

1. Attach your external displays to the external monitor port and HDMI-Out port, and turn them on.
2. Go to the **Intel(R) HD Graphics Control Panel** control panel and click **Display > Multiple Displays** (sub-menu).
3. Click **Collage** from the **Select Multiple Display Mode** menu.
4. Click **Enable Collage** and click **On**.
5. Click **Vertical** or **Horizontal** to arrange and displays as required.
6. Click **Apply**, and **OK** to confirm the settings change.

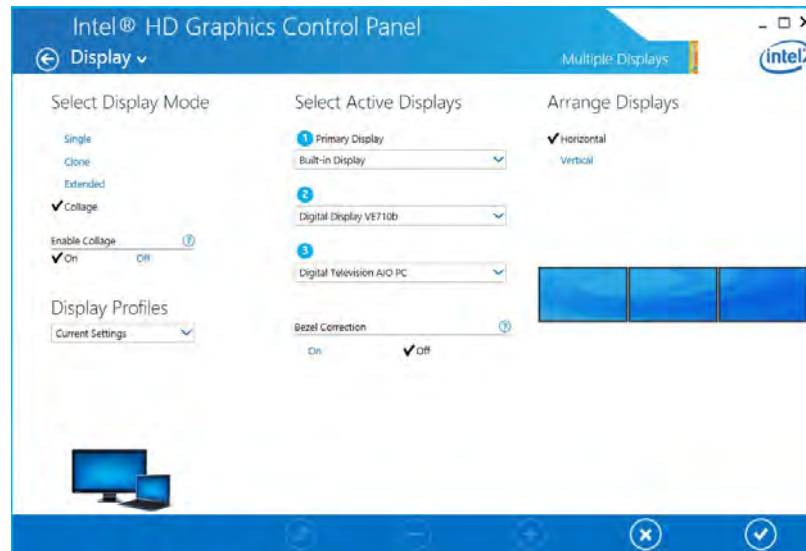

Figure C - 17

### Display > Multiple Displays (Collage)



## Attaching Other Displays - Devices (Charms Bar)

You can configure attached displays from **Devices** (in the **Charms Bar**).

1. Attach your external display to the external monitor port/HDMI-Out port, and turn it on.
2. Go the **Charms Bar**, select **Devices**.
3. Click **Project** (you may need to click **Second Screen**).
4. Click on any one of the options from the menu to select **PC screen only**, **Duplicate**, **Extend** or **Second screen only**.

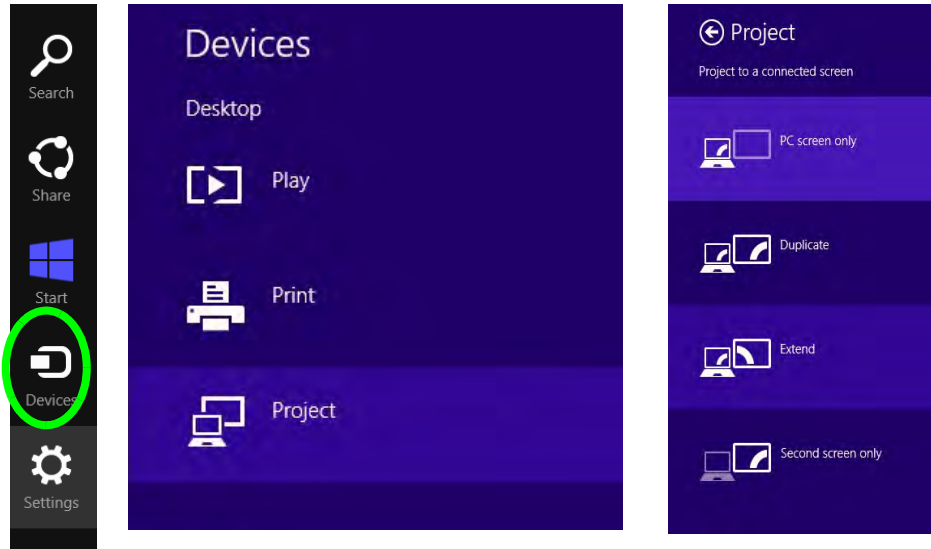

### Windows Logo Key + P Key Combination

You can use the **Windows Logo Key + P** key combination to quickly bring up the **Second Screen** menu.

You can also use the **Display Switch** button in the **Control Center** to access the menu and select the appropriate attached display mode.

You can also use the **Fn + F7** key combination to quickly access the **Second Screen** menu in **Windows**.

*Figure C - 18*  
**Second Screen**  
**(Devices)**

### Configuring an External Display In Windows

1. Attach your external display to the external monitor port/HDMI-Out port, and turn it on.
2. Go to the **Screen resolution** control panel (see page 1 - 27) in the Desktop app.
3. Click the **Detect** button.
4. The computer will then detect any attached displays.

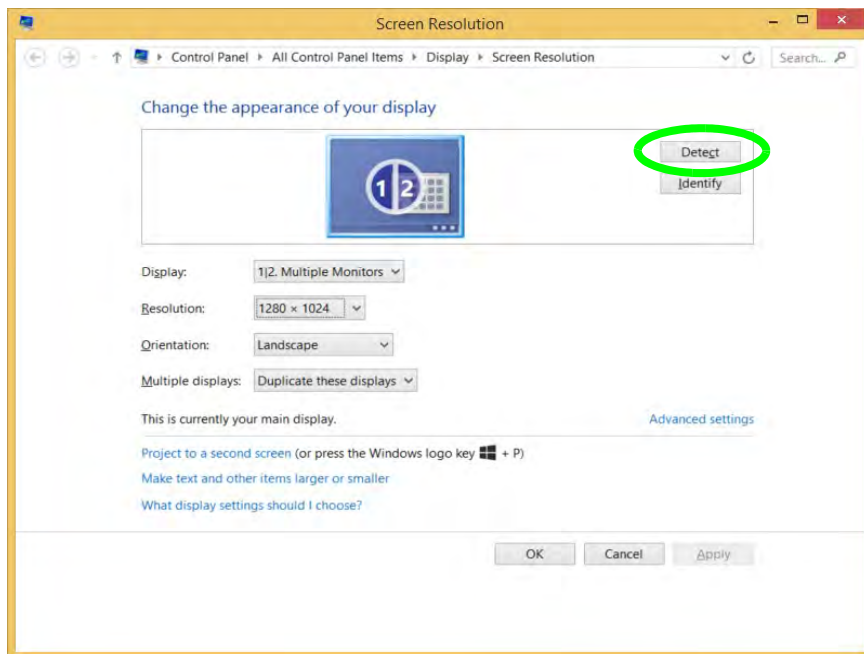

*Figure C - 19*  
**Screen Resolution**  
**Multiple Displays**

5. You can configure the displays from the **Multiple Displays** menu.

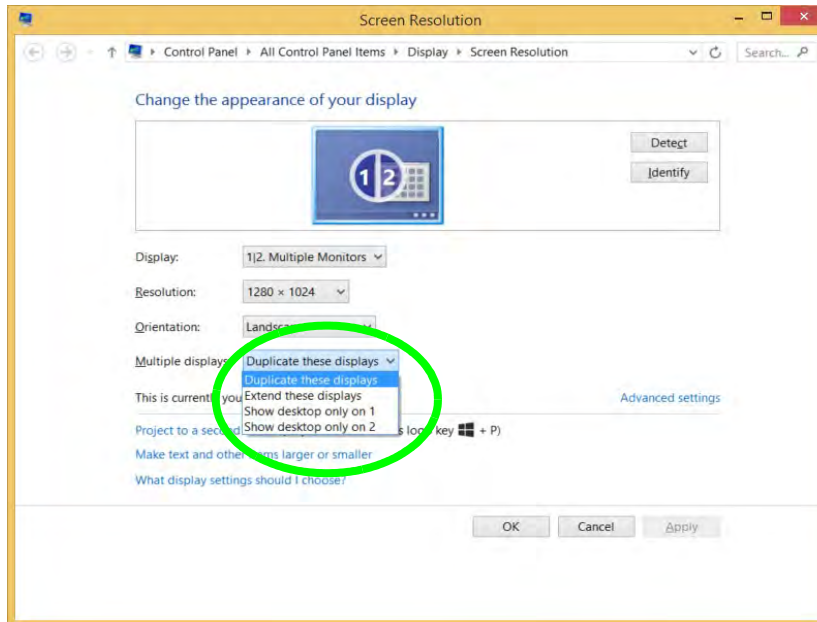

*Figure C - 20*  
Screen Resolution  
Multiple Display  
Options

- Duplicate these displays - Shows an exact copy of the main display desktop on the other display(s)
- Extend these displays - Treats both connected displays as **separate** devices
- Show desktop only on 1/2 - Only one of your displays is used.



### NVIDIA Control Panel

To access the **GeForce.....** control panel from the desktop; right-click the **desktop**, then click **NVIDIA Control Panel**.

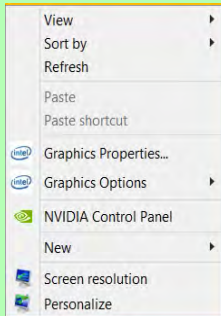

Figure C - 21

### NVIDIA GeForce..... Control Panel

## NVIDIA Control Panel

More advanced video configuration options are provided in the **NVIDIA Control Panel** tab.

1. Go to the **Control Panel**.
2. Double-click **NVIDIA Control Panel** (click to view the control panel in either **Large icons** or **Small icons** if you are in **Category** view).

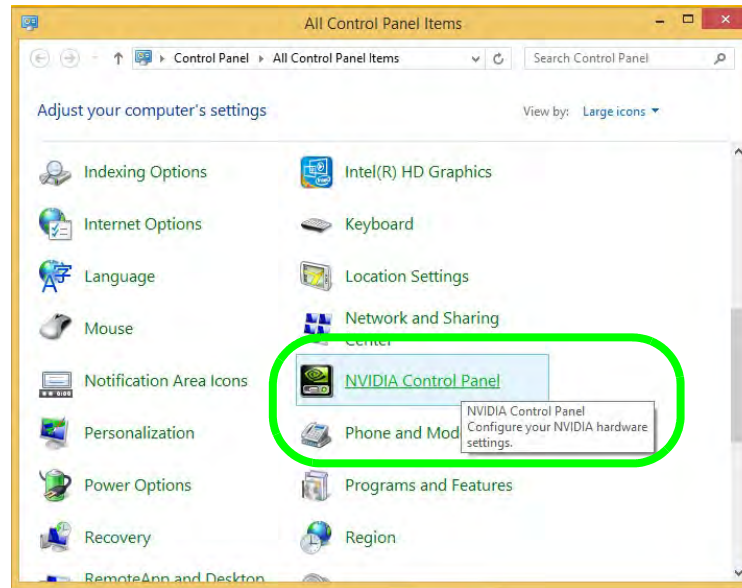

The **NVIDIA Control Panel** provides additional video configuration controls and tools which allow quick access to features such as image settings, 3D Settings and video configuration.



### Navigating the Control Panel

Navigate through the control panels in much the same way as you would a web page. Click on the sub-heading tasks in the left menu (and on the highlighted links) for information. Use the buttons on the top left to go back, forward etc.

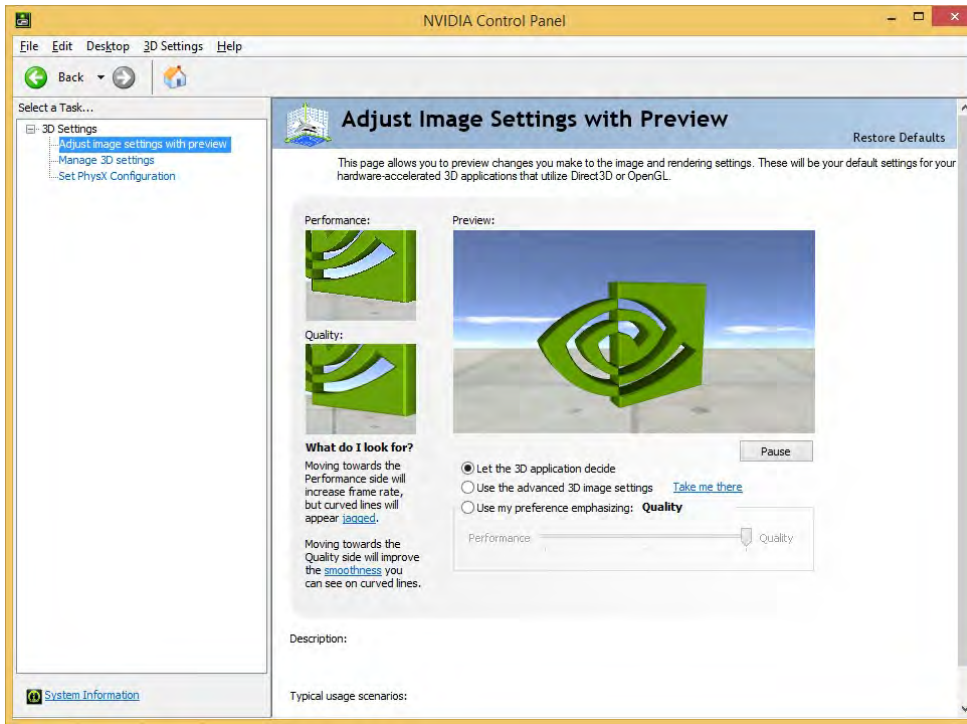
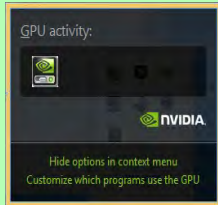

Figure C - 22  
NVIDIA Control  
Panel



### Display GPU Activity Icon

Click to enable **Display GPU Activity Icon in the Notification Area** to quickly access the GPU Activity monitor from the taskbar.



## Customization Options

One of the most important aspects of **Hybrid Graphics** technology is that it will switch between the integrated GPU and discrete GPU seamlessly and automatically, and does not require any input from the user. However customization options are offered for users who prefer to set their own parameters for GPU usage.

### Context Menu

One of the quickest ways to choose which GPU to use for a particular application is by using the **“Run with graphics processor”** in the context menu.

1. Go to the **NVIDIA Control Panel** (see page [C - 26](#)).
2. Click **Desktop** from the top menu and select **Add “Run with graphics processor” to Context Menu** (it should have a check alongside it).

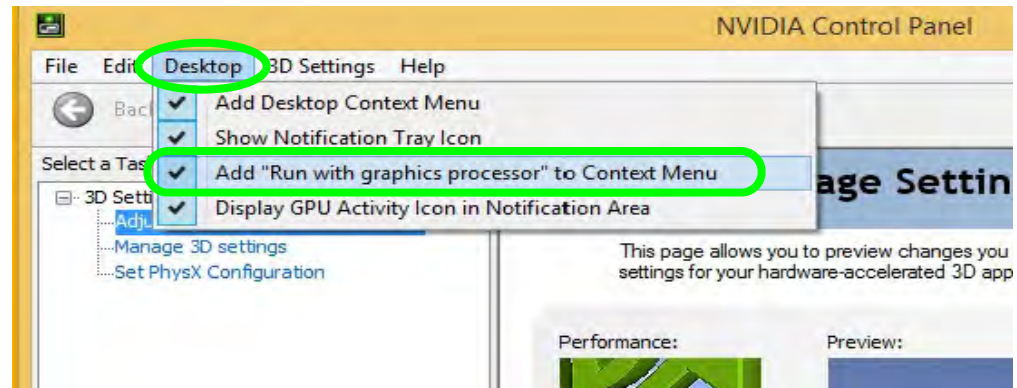

*Figure C - 23*  
**NVIDIA Control Panel - View**

3. Close the **NVIDIA Control Panel**.
4. Find the executable file icon of the application you want to run.
5. Right-click the icon and select **Run with graphics processor** from the context menu.
6. Select either **High-performance NVIDIA processor (dGPU)** or **Integrated graphics (iGPU)** to run the program with the selected GPU.

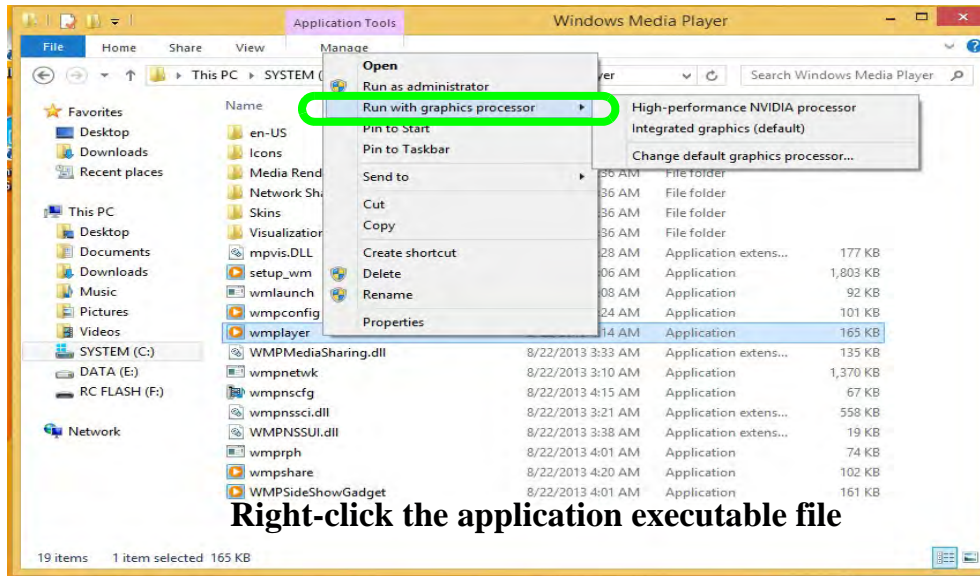

**Right-click the application executable file**



### iGPU or dGPU

Note the NVIDIA control panel refers to **High-performance NVIDIA processor** (which is the discrete GPU) and **Integrated graphics** (which is the integrated GPU).

*Figure C - 24*

**Context Menu with  
Run with graphics  
processor**

C

### Global Settings

Global settings allows you to set the preferred graphics processor for overall use. Ideally this would be the iGPU for battery life, but this can be set to the dGPU if preferred.

1. Go to the **NVIDIA Control Panel** (see page **C - 26**).
2. Click **Manage 3D Settings (3D Settings)** and select **Global Settings** (tab).
3. Select either **Integrated graphics (iGPU)** or **High performance NVIDIA Processor (dGPU)** from the drop-down menu.
4. Click the **Setting** menu items to select any options required.
5. Click **Apply** to save the settings.

*Figure C - 25*  
**Global Settings**

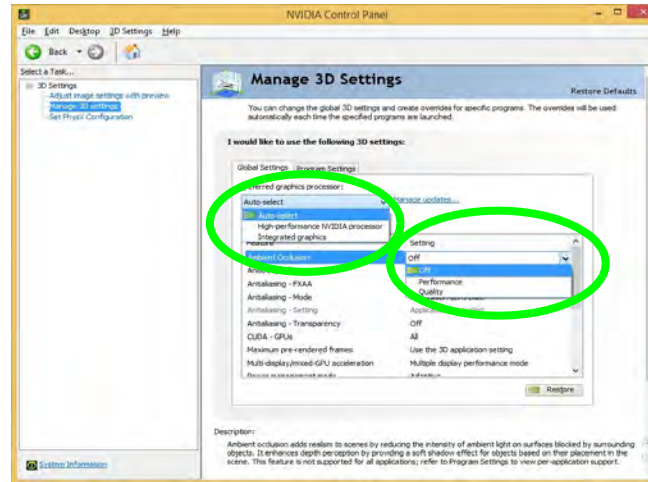



## Program Settings

Program settings allows you to make specific adjustments for installed applications.

1. Go to the **NVIDIA Control Panel** (see page **C - 26**).
2. Click **Manage 3D Settings (3D Settings)** and select **Program Settings** (tab).
3. **Select a program to customize** from the drop-down menu, or click **Add** to add any program that does not appear in the menu.
4. **Select the preferred graphics processor for the program** from the drop-down menu.
5. Click the **Setting** menu items to select any options required.
6. Click **Apply** to save the settings.

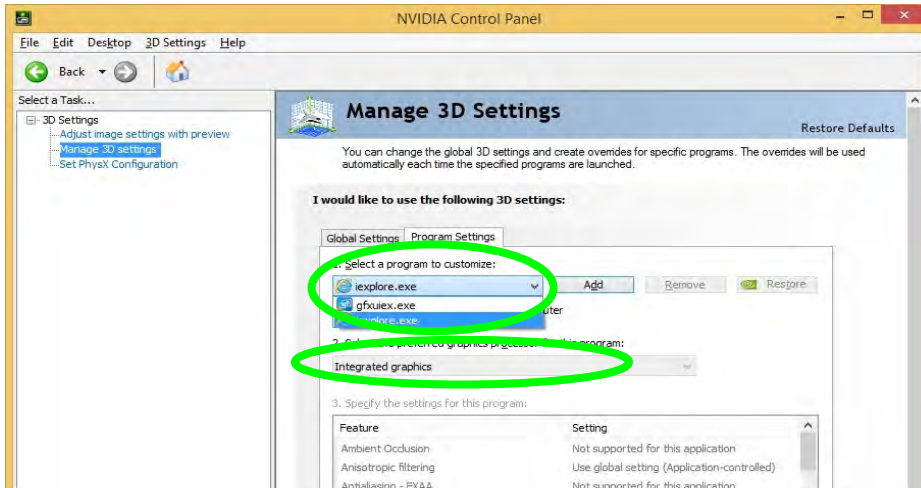

Figure C - 26  
Program Settings

# Set PhysX® Configuration

NVIDIA® PhysX® is a physics engine that can use the GPU to accelerate game and 3D application performance. You can select the GeForce video card or CPU as a PhysX® processor, or configure the computer to auto-select a PhysX® processor (recommended default setting).

1. Go to **NVIDIA Control Panel** (see page **C - 26**).
2. Click **Set PhysX configuration**.
3. Click to **Select a PhysX processor** from the menu; Auto-select (recommended) is the default setting.
4. Click **Apply** to save the settings.

*Figure C - 27*  
**Set PhysX®  
Configuration**

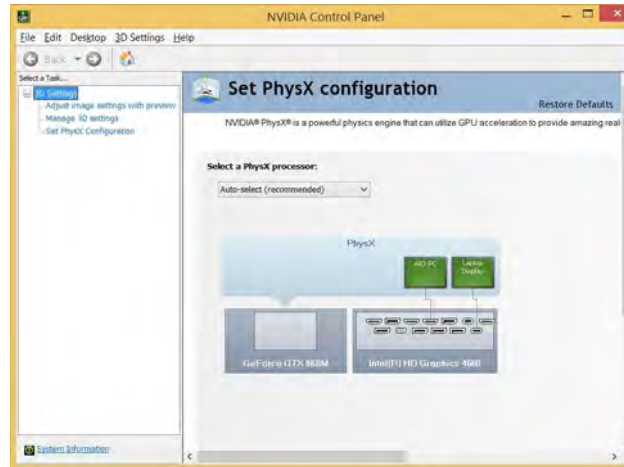

## HDMI Audio Configuration

HDMI (High-Definition Multimedia Interface) carries both **audio** and video signals. In some cases it will be necessary to go to the **Sound** control panel and manually configure the HDMI audio output as per the instructions below.

1. Go to the **Control Panel**.
2. Click **Sound** (Hardware and Sound) and click **Playback** (tab)
3. Depending on your display, the playback device may be selected, however in some cases you may need to select the audio device and click **Set Default** (button).
4. Double-click the device to access the control panel tabs illustrated overleaf.

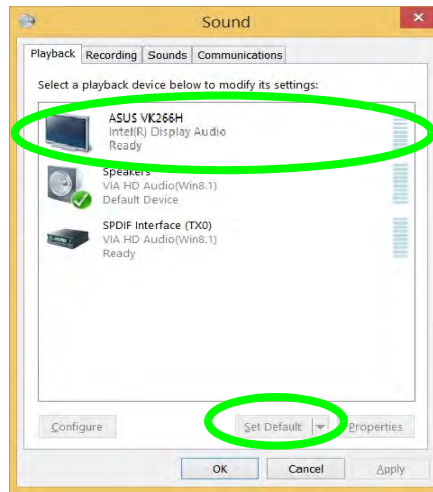

### Volume Adjustment

The sound volume level can be set using the volume control in the **Settings** menu in the **Charms Bar**.

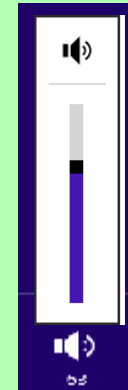

Figure C - 28

**Sound - HDMI  
Device (set Default)**

## Video Driver Controls

- Adjust the HDMI settings from the control panel tabs.
- Click **OK** to close the **Sound** control panel.

Figure C - 29  
HDMI Device  
Properties

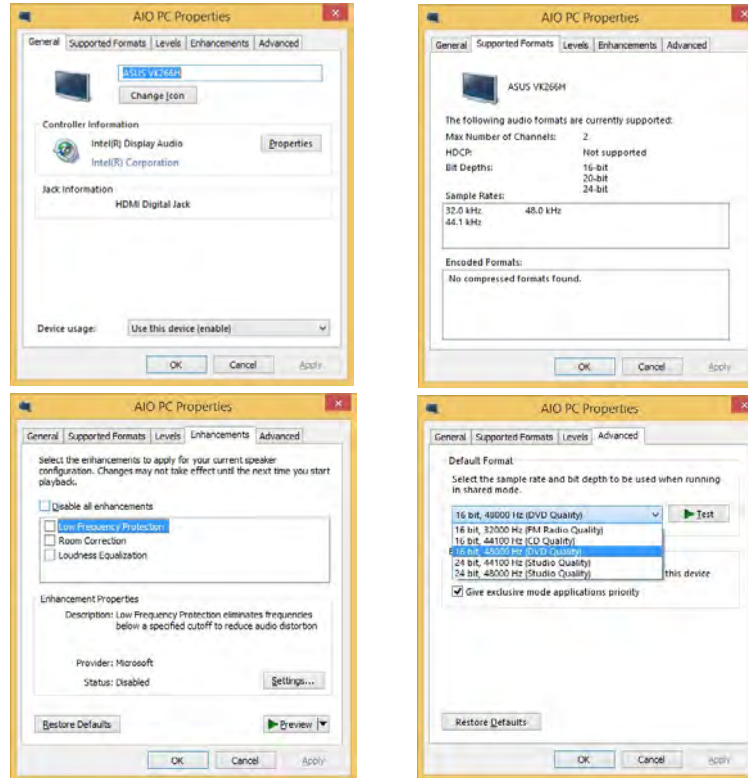

## HDMI Notes

- Connect a device with HDMI support to the HDMI-Out port **BEFORE** attempting to play audio/video sources through the device.
- To play audio sources through your external display's (TV or LCD) speakers you will need to go to the audio configuration control panel on the display and configure the audio input accordingly (see your display device manual).

## HDMI Video Configuration

1. Connect an HDMI cable from the HDMI-Out port to your external display.
2. Configure your external display as per the instructions in *“Attaching Other Displays” on page C - 20*.
3. Set up your external display (TV or LCD) for HDMI input (see your display device manual).
4. You can now play video/audio sources through your external display.

## Sound Blaster Cinema EQ & HDMI

1. When you connect an HDMI display to the HDMI-Out port, the Sound Blaster Cinema EQ controls will be disabled.
2. A warning box will pop-up and will prompt *“...Do you want to select another audio device now?”*.
3. Click **No** to continue using the HDMI audio output from your external display (do not attempt to select another audio device when connected to the external HDMI display).



### Other Applications

If you are using a third party application to play DVDs etc. from any attached DVD device, you will need to consult the application's documentation to see the appropriate audio configuration (the application must support digital to analog translation).

## Video Driver Controls

C

# Appendix D: Specifications



## Latest Specification Information

The specifications listed in this Appendix are correct at the time of going to press. Certain items (particularly processor types/speeds and CD/DVD device types) may be changed, updated or delayed due to the manufacturer's release schedule. Check with your distributor/supplier for details.

## Specifications

### Processor

**Intel® Core™ i7-4910MQ (2.9GHz)****Mobile Processor**

8M L3 Cache, 22nm (22 Nanometer),  
DDR3L-1600MHz, TDP 47W

**Intel® Core™ i7-4900MQ (2.8GHz)****Mobile Processor**

8M L3 Cache, 22nm (22 Nanometer),  
DDR3L-1600MHz, TDP 47W

**Intel® Core™ i7-4810MQ (2.8GHz)****Mobile Processor**

6M L3 Cache, 22nm (22 Nanometer),  
DDR3L-1600MHz, TDP 47W

**Intel® Core™ i7-4800MQ (2.7GHz)****Mobile Processor**

6M L3 Cache, 22nm (22 Nanometer),  
DDR3L-1600MHz, TDP 47W

**Intel® Core™ i7-4700MQ (2.4GHz)****Mobile Processor**

6M L3 Cache, 22nm (22 Nanometer),  
DDR3L-1600MHz, TDP 47W

**Intel® Core™ i7-4610M (3.0GHz)****Mobile Processor**

4M L3 Cache, 22nm (22 Nanometer),  
DDR3L-1600MHz, TDP 37W

**Intel® Core™ i7-4600M (2.9GHz)****Mobile Processor**

4M L3 Cache, 22nm (22 Nanometer),  
DDR3L-1600MHz, TDP 37W

**Intel® Core™ i5-4340M (2.9GHz)****Mobile Processor**

3M L3 Cache, 22nm (22 Nanometer),  
DDR3L-1600MHz, TDP 37W

**Intel® Core™ i5-4330M (2.8GHz)****Mobile Processor**

3M L3 Cache, 22nm (22 Nanometer),  
DDR3L-1600MHz, TDP 37W

**Intel® Core™ i5-4310M (2.7GHz)****Mobile Processor**

3M L3 Cache, 22nm (22 Nanometer),  
DDR3L-1600MHz, TDP 37W

**Intel® Core™ i5-4300M (2.6GHz)****Mobile Processor**

3M L3 Cache, 22nm (22 Nanometer),  
DDR3L-1600MHz, TDP 37W

**Intel® Core™ i5-4200M (2.5GHz)****Mobile Processor**

3M L3 Cache, 22nm (22 Nanometer),  
DDR3L-1600MHz, TDP 37W

**Intel® Core™ i3-4100M (2.5GHz)****Mobile Processor**

3M L3 Cache, 22nm (22 Nanometer),  
DDR3L-1600MHz, TDP 37W

**Intel® Core™ i3-4000M (2.4GHz)****Mobile Processor**

3M L3 Cache, 22nm (22 Nanometer),  
DDR3L-1600MHz, TDP 37W

### Core Logic

Mobile Intel® HM87 Express Chipset

### Display

**Models A & C:**

15.6" (39.62cm) FHD (1920 \* 1080), 16:9  
Backlit Panel

**Model B:**

17.3" (43.94cm) FHD (1920 \* 1080), 16:9  
Backlit Panel

(see over)



<b>Memory</b>	<b>nVIDIA® GeForce GTX 860M</b> PCIe * 8 Video Chip <b>2GB</b> GDDR5 Video RAM On Board Supports Microsoft DirectX® 11 NVIDIA PhysX™ GeForce CUDA™ Technology	<b>Keyboard &amp; Pointing Device</b>
Dual Channel <b>DDR3L</b>  *Three 204 Pin SO-DIMM Sockets Supporting <b>DDR3L 1600 MHz</b> Memory Modules ( <i>real operational frequency depends on the FSB of the processor</i> )  *Note: Two DIMMs per channel is only supported by Quad-Core CPUs  Memory Expandable up to 24GB Compatible with 2GB, 4GB or 8GB Modules	<b>Storage</b>	Built-In TouchPad (with Multi Gesture Functionality) One Control Center Launch Button  <b>Models A &amp; B:</b> Full Size Isolated Winkey Keyboard with Numeric Keypad  <b>Model C:</b> Full Size Isolated Illuminated Keyboard with Numeric Pad  <b>Model B:</b> Three Instant Buttons for Airplane Mode, Mute & Camera On/Off
<b>Video Adapter Options</b>	One 12.7 mm Super Multi/Blu-Ray Combo/Blu-Ray Writer SATA Optical Device Drive ( <b>Factory Option</b> )	<b>Interface</b>
<u><b>Intel® Integrated GPU and NVIDIA® GeForce Video:</b></u> <b>Supports Microsoft Hybrid Graphics Switchable GPU Technology between iGPU and dGPU</b>  <b>Intel® HD Graphics 4600 (GPU Type Depends on Processor)</b> Dynamic Frequency Intel® Dynamic Video Memory Technology Supporting Shared Memory up to 1.7GB Supports Microsoft DirectX® 11	Up to Two ( <b>Factory Option</b> ) Changeable 2.5" 9.5 mm / 7mm (h) <b>SATA</b> (Serial) Hard Disks Drives / Solid State Drives with RAID Level 0/1 Support	One USB 2.0 Port Two USB 3.0 Ports One eSATA Port (SATA/USB 3.0 Combo) One External Monitor Port One HDMI™-Out (High-Definition Multimedia Interface) Port (with HDCP) One Microphone-In Jack One Headphone/Speaker-Out Jack One S/PDIF Out Jack One RJ-45 LAN Jack One DC-In Jack
	<b>Audio</b>	
	High Definition Audio S/PDIF Digital Output Built-In Microphone 2 Built-In 2W Speakers Sound Blaster™ Cinema	



## Specifications

<p><b>Card Reader</b></p>	<p><b>Communication</b></p>	<p><b><u>For Models A &amp; C Only:</u></b>            UMTS/HSPA+ based <b>3G Module</b> with Full Size Mini-Card Interface (<b>Factory Option</b>)            Quad-band GSM/GPRS (850 MHz, 900 MHz, 1800 MHz, 1900 MHz)            UMTS WCDMA FDD (2100 MHz)            Note that UMTS modes CAN NOT be used in North America</p>
<p>Embedded Multi-In-1 Push-Push Card Reader</p> <ul style="list-style-type: none"> <li>- MMC / RSMCC</li> <li>- SD / Mini SD / SDHC / SDXC</li> <li>- MS / MS Pro / MS Duo</li> </ul> <p><b>Note:</b> Some of these cards require PC adapters that are usually supplied with the cards.</p>	<p>Built-In 10/100/1000Mb Base-TX Ethernet LAN</p> <p><b>Intel® Dual Band Wireless-AC 7260</b> (2*2 802.11 a/c) Half Mini-Card PCIe WLAN + Bluetooth Combo Module (<b>Factory Option</b>)</p> <p><b>Intel® Wireless-N 7260</b> (2*2 802.11 b/g/n) Half Mini-Card PCIe WLAN + Bluetooth Combo Module (<b>Factory Option</b>)</p> <p>(802.11b/g/n) Half Mini-Card PCIe WLAN + Bluetooth V4.0+LE Combo Module (<b>Factory Option</b>)</p> <p>(802.11b/g/n) Half Mini-Card PCIe WLAN Module with PCIe Interface (<b>Factory Option</b>)</p> <p><b>Qualcomm® Atheros Killer™</b> Wireless-N 1202 Dual Band (2*2 802.11 a/b/g/n) Half Mini-Card PCIe WLAN + Bluetooth Combo Module (<b>Factory Option</b>)</p> <p>1.0M HD PC Video Camera Module  <b>OR</b>            2.0M FHD PC Video Camera Module (<b>Factory Option</b>)</p>	<p><b>BIOS</b></p> <p>One 48Mb SPI Flash ROM            AMI BIOS</p>
<p><b>Slots</b></p>		<p><b>Security</b></p>
<p>Two Mini-Card Slots:</p> <p><b>Slot 1</b> for Half Size Mini-Card WLAN Combo Module with PCIe &amp; USB Interfaces:</p> <p><b>Slot 2</b> for Full Size Mini-Card mSATA SSD (Solid State Drive) with SATA Interface (<b>Factory Option</b>)</p> <p><b>OR</b></p> <p><b><u>For Models A &amp; C Only:</u></b>            Full Size Mini-Card <b>3G Module</b> with USB Interface (<b>Factory Option</b>)</p>		<p>Security (Kensington® Type) Lock Slot            BIOS Password            Trusted Platform Module 1.2 (<b>Factory Option</b>)</p> <p><b><u>For Models A &amp; C Only:</u></b>            Fingerprint Reader Module (<b>Factory Option</b>)</p>
		<p><b>Operating System</b></p> <p>Windows 8.1 (64-bit)</p>

Features	Environmental Spec
<p>IMR (Injected Molded Resin) LCD Back Covers for some <b>Models A &amp; C</b> Designs</p> <p>Painted Style for some <b>Model B</b> Designs</p> <p>Intel® Rapid Start Technology</p> <p>Intel® Smart Response Technology</p>	<p>Temperature</p> <p>Operating: 5°C - 35°C</p> <p>Non-Operating: -20°C - 60°C</p> <p>Relative Humidity</p> <p>Operating: 20% - 80%</p> <p>Non-Operating: 10% - 90%</p>
Indicators	Physical Dimensions & Weight
<p>LED Indicators - Power/Suspend, Battery, HDD/ODD, Airplane Mode, Num Lock, Caps Lock, Scroll Lock, Camera, Touchpad Working &amp; Mute Working</p>	<p><b><u>Model A:</u></b> 374mm (w) * 250mm (d) * 16.3 - 42.7mm (h) 2.7kg with ODD and Battery</p> <p><b><u>Model B:</u></b> 413mm (w) * 277.5mm (d) * 17.5 - 44mm (h) 3.2kg with ODD and Battery</p> <p><b><u>Model C:</u></b> 374mm (w) * 250mm (d) * 16.7 - 43.1mm (h) 2.7kg with ODD and Battery</p>
Power	
<p>Full Range AC/DC Adapter – AC in 100 - 240V, 50 - 60Hz DC Output 19.5V, 6.15A (<b>120 Watts</b>)</p> <p>Removable 8 Cell Smart Lithium Ion Battery Pack 76.96WH</p>	
Power Management	
<p>Supports Wake on LAN</p> <p>Supports Wake on USB</p> <p>Supports Wake on RTC Alarm (AC Mode Only)</p>	

## Specifications

D