

USER'S MANUAL



notebook

Notice

The company reserves the right to revise this publication or to change its contents without notice. Information contained herein is for reference only and does not constitute a commitment on the part of the manufacturer or any subsequent vendor. They assume no responsibility or liability for any errors or inaccuracies that may appear in this publication nor are they in anyway responsible for any loss or damage resulting from the use (or misuse) of this publication.

This publication and any accompanying software may not, in whole or in part, be reproduced, translated, transmitted or reduced to any machine readable form without prior consent from the vendor, manufacturer or creators of this publication, except for copies kept by the user for backup purposes.

Brand and product names mentioned in this publication may or may not be copyrights and/or registered trademarks of their respective companies. They are mentioned for identification purposes only and are not intended as an endorsement of that product or its manufacturer.

©March 2016

Trademarks

Intel, **Pentium** and **Intel Celeron** are trademarks/registered trademarks of Intel Corporation.



Preface

R&TTE Directive

This device is in compliance with the essential requirements and other relevant provisions of the R&TTE Directive 1999/5/EC.

This device will be sold in the following EEA countries: Austria, Italy, Belgium, Liechtenstein, Denmark, Luxembourg, Finland, Netherlands, France, Norway, Germany, Portugal, Greece, Spain, Iceland, Sweden, Ireland, United Kingdom, Cyprus, Czech Republic, Estonia, Hungary, Latvia, Lithuania, Malta, Slovakia, Poland, Slovenia.

ErP Off Mode Power Consumption Statement:

The figures below note the power consumption of this computer in compliance with European Commission (EC) regulations on power consumption in off mode:

- Off Mode < 0.5W

CE Marking

This device has been tested to and conforms to the regulatory requirements of the European Union and has attained CE Marking. The CE Mark is a conformity marking consisting of the letters “CE”. The CE Mark applies to products regulated by certain European health, safety and environmental protection legislation. The CE Mark is obligatory for products it applies to: the manufacturer affixes the marking in order to be allowed to sell his product in the European market.

This product conforms to the essential requirements of the R&TTE directive 1999/5/EC in order to attain CE Marking. A notified body has determined that this device has properly demonstrated that the requirements of the directive have been met and has issued a favorable certificate of expert opinion. As such the device will bear the notified body number 0560 after the CE mark.

The CE Marking is not a quality mark. Foremost, it refers to the safety rather than to the quality of a product. Secondly, CE Marking is mandatory for the product it applies to, whereas most quality markings are voluntary.

FCC Statement (Federal Communications Commission)

You are cautioned that changes or modifications not expressly approved by the party responsible for compliance could void the user's authority to operate the equipment.

This equipment has been tested and found to comply with the limits for a Class B digital device, pursuant to Part 15 of the FCC Rules. These limits are designed to provide reasonable protection against harmful interference in a residential installation. This equipment generates, uses and can radiate radio frequency energy and, if not installed and used in accordance with the instructions, may cause harmful interference to radio communications. However, there is no guarantee that interference will not occur in a particular installation. If this equipment does cause harmful interference to radio or television reception, which can be determined by turning the equipment off and on, the user is encouraged to try to correct the interference by one or more of the following measures:

- Re orient or relocate the receiving antenna.
- Increase the separation between the equipment and receiver.
- Connect the equipment into an outlet on a circuit different from that to which the receiver is connected.
- Consult the service representative or an experienced radio/TV technician for help.

Operation is subject to the following two conditions:

1. This device may not cause interference.

And

2. This device must accept any interference, including interference that may cause undesired operation of the device.

FCC RF Radiation Exposure Statement:

1. This Transmitter must not be co-located or operating in conjunction with any other antenna or transmitter.
2. This equipment complies with FCC RF radiation exposure limits set forth for an uncontrolled environment. This equipment should be installed and operated with a minimum distance of 20 centimeters between the radiator and your body.



Warning

Use only shielded cables to connect I/O devices to this equipment. You are cautioned that changes or modifications not expressly approved by the manufacturer for compliance with the above standards could void your authority to operate the equipment.

IMPORTANT SAFETY INSTRUCTIONS

Follow basic safety precautions, including those listed below, to reduce the risk of fire, electric shock, and injury to persons when using any electrical equipment:

1. Do not use this product near water, for example near a bath tub, wash bowl, kitchen sink or laundry tub, in a wet basement or near a swimming pool.
2. Avoid using this equipment with a telephone line (other than a cordless type) during an electrical storm. There may be a remote risk of electrical shock from lightning.
3. Do not use the telephone to report a gas leak in the vicinity of the leak.
4. Use only the power cord and batteries indicated in this manual. Do not dispose of batteries in a fire. They may explode. Check with local codes for possible special disposal instructions.
5. This product is intended to be supplied by a Listed Power Unit according to the model's requirements:
 - Full Range AC/DC Adapter - AC Input 100 - 240V, 50 - 60Hz, DC Output 19V, 2.1A (**40W**) minimum.

This Computer's Optical Device is a Laser Class 1 Product

Instructions for Care and Operation

The notebook computer is quite rugged, but it can be damaged. To prevent this, follow these suggestions:

1. **Don't drop it, or expose it to shock.** If the computer falls, the case and the components could be damaged.



2. **Keep it dry, and don't overheat it.** Keep the computer and power supply away from any kind of heating element. This is an electrical appliance. If water or any other liquid gets into it, the computer could be badly damaged.

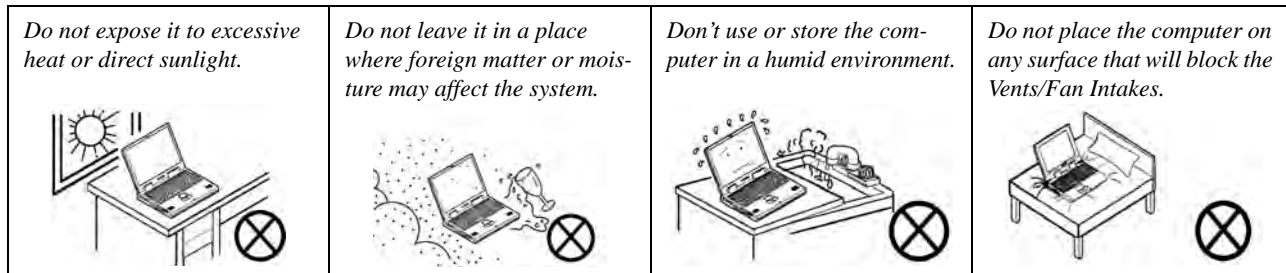

Preface

- Avoid interference.** Keep the computer away from high capacity transformers, electric motors, and other strong magnetic fields. These can hinder proper performance and damage your data.
- Follow the proper working procedures for the computer.** Shut the computer down properly and don't forget to save your work. Remember to periodically save your data as data may be lost if the battery is depleted.

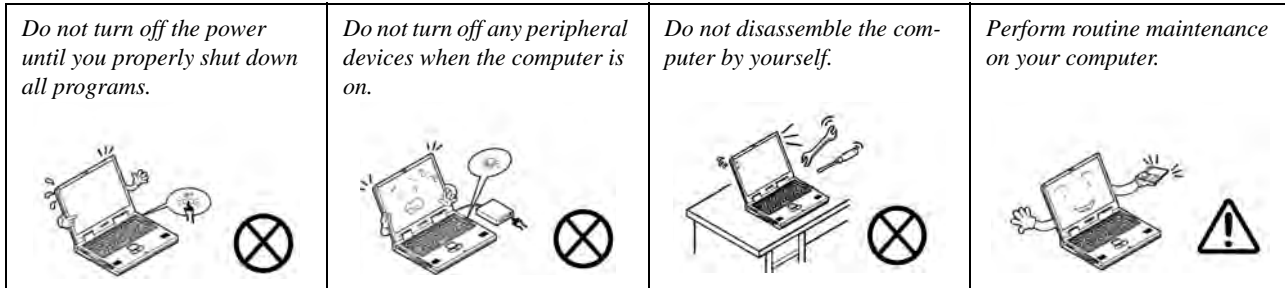

- Take care when using peripheral devices.**



Servicing

Do not attempt to service the computer yourself. Doing so may violate your warranty and may expose you and the computer to electric shock. Refer all servicing to authorized service personnel. Unplug the computer from the power supply. Then refer servicing to qualified service personnel under any of the following conditions:

- When the power cord or AC/DC adapter is damaged or frayed.
- If the computer has been exposed to rain or other liquids.
- If the computer does not work normally when you follow the operating instructions.
- If the computer has been dropped or damaged (do not touch the poisonous liquid if the LCD panel breaks).
- If there is an unusual odor, heat or smoke coming from your computer.



Bottom Cover Removal Warning

Users should not remove any cover(s) and /or screw(s) for the purposes of device upgrade as this may violate the terms of your warranty. If you need to replace/remove the hard disk/RAM/optical device etc., for any reason, please contact your distributor/supplier for further information.

Removal Warning

When removing any cover(s) and screw(s) for the purposes of device upgrade, remember to replace the cover(s) and screw(s) before restoring power to the system.

Also note the following when the cover is removed:

- Hazardous moving parts.
- Keep away from moving fan blades.

Power Safety

The computer has specific power requirements:



Power Safety Warning

Before you undertake any upgrade procedures, make sure that you have turned off the power, and disconnected all peripherals and cables (including telephone lines and power cord).

You must also remove your battery in order to prevent accidentally turning the machine on. **Before removing the battery disconnect the AC/DC adapter from the computer.**

- Only use a power adapter approved for use with this computer.
- Your AC/DC adapter may be designed for international travel but it still requires a steady, uninterrupted power supply. If you are unsure of your local power specifications, consult your service representative or local power company.
- The power adapter may have either a 2-prong or a 3-prong grounded plug. The third prong is an important safety feature; do not defeat its purpose. If you do not have access to a compatible outlet, have a qualified electrician install one.
- When you want to unplug the power cord, be sure to disconnect it by the plug head, not by its wire.
- Make sure the socket and any extension cord(s) you use can support the total current load of all the connected devices.
- Before cleaning the computer, make sure it is disconnected from any external power supplies (i.e. AC/DC adapter or car adapter).

Do not plug in the power cord if you are wet.



Do not use the power cord if it is broken.



Do not place heavy objects on the power cord.

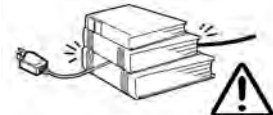

Polymer Battery Precautions

Note the following information which is specific to polymer batteries only, and where applicable, this overrides the general battery precaution information overleaf.

- Polymer batteries may experience a slight expansion or swelling, however this is part of the battery's safety mechanism and is not a cause for concern.
- Use proper handling procedures when using polymer batteries. Do not use polymer batteries in high ambient temperature environments, and do not store unused batteries for extended periods.

See also the general battery precautionary information overleaf for further information.

General Battery Precautions

- Only use batteries designed for this computer. The wrong battery type may explode, leak or damage the computer.
- Do not remove any batteries from the computer while it is powered on.
- Do not continue to use a battery that has been dropped, or that appears damaged (e.g. bent or twisted) in any way. Even if the computer continues to work with a damaged battery in place, it may cause circuit damage, which may possibly result in fire.
- If you do not use the battery for an extended period, then remove the battery from the computer for storage.
- Recharge the batteries using the notebook's system. Incorrect recharging may make the battery explode.
- Do not try to repair a battery pack. Refer any battery pack repair or replacement to your service representative or qualified service personnel.
- Keep children away from, and promptly dispose of a damaged battery. Always dispose of batteries carefully. Batteries may explode or leak if exposed to fire, or improperly handled or discarded.
- Keep the battery away from metal appliances.
- Affix tape to the battery contacts before disposing of the battery.
- Do not touch the battery contacts with your hands or metal objects.



Battery Disposal & Caution

The product that you have purchased contains a rechargeable battery. The battery is recyclable. At the end of its useful life, under various state and local laws, it may be illegal to dispose of this battery into the municipal waste stream. Check with your local solid waste officials for details in your area for recycling options or proper disposal.

Danger of explosion if battery is incorrectly replaced. Replace only with the same or equivalent type recommended by the manufacturer. Discard used battery according to the manufacturer's instructions.

Cleaning

Do not apply cleaner directly to the computer; use a soft clean cloth.

Do not use volatile (petroleum distillates) or abrasive cleaners on any part of the computer.

Servicing

Do not attempt to service the computer yourself. Doing so may violate your warranty and expose you and the computer to electric shock. Refer all servicing to authorized service personnel. Unplug the computer from the power supply and then refer servicing to qualified service personnel under any of the following conditions:

- When the power cord or AC/DC adapter is damaged or frayed.
- If the computer has been exposed to rain or other liquids.
- If the computer does not work normally when you follow the operating instructions.
- If the computer has been dropped or damaged (do not touch the poisonous liquid if the LCD panel breaks).
- If there is an unusual odor, heat or smoke coming from your computer.



Removal Warning

When removing any cover(s) and screw(s) for the purposes of device upgrade, remember to replace the cover(s) and screw(s) before restoring power to the system.

Also note the following when the cover is removed:

- Hazardous moving parts.
- Keep away from moving fan blades.

Travel Considerations

As you get ready for your trip, run through this list to make sure the system is ready to go:

1. Check that the battery pack and any spares are fully charged.
2. Power off the computer and peripherals.
3. Close the display panel and make sure it's latched.
4. Disconnect the AC/DC adapter and cables. Stow them in the carrying bag.
5. The AC/DC adapter uses voltages from 100 to 240 volts so you won't need a second voltage adapter. However, check with your travel agent to see if you need any socket adapters.
6. Put the notebook in its carrying bag and secure it with the bag's straps.
7. If you're taking any peripherals (e.g. a printer, mouse or digital camera), pack them and those devices' adapters and/or cables.
8. Anticipate customs - Some jurisdictions may have import restrictions or require proof of ownership for both hardware and software. Make sure your "papers" are handy.



Power Off Before Traveling

Make sure that your notebook is completely powered off before putting it into a travel bag (or any such container). Putting a notebook which is powered on in a travel bag may cause the Vents/Fan Intakes to be blocked. To prevent your computer from overheating make sure nothing blocks the Vent/Fan Intakes while the computer is in use.

On the Road

In addition to the general safety and maintenance suggestions in this preface, and Chapter 8: Troubleshooting, keep these points in mind:

Hand-carry the notebook - For security, don't let it out of your sight. In some areas, computer theft is very common. Don't check it with "normal" luggage. Baggage handlers may not be sufficiently careful. Avoid knocking the computer against hard objects.

Beware of Electromagnetic fields - Devices such as metal detectors & X-ray machines can damage the computer, hard disk, floppy disks, and other media. They may also destroy any stored data - Pass your computer and disks around the devices. Ask security officials to hand-inspect them (you may be asked to turn it on). **Note:** Some airports also scan luggage with these devices.

Fly safely - Most airlines have regulations about the use of computers and other electronic devices in flight. These restrictions are for your safety, follow them. If you stow the notebook in an overhead compartment, make sure it's secure. Contents may shift and/or fall out when the compartment is opened.

Get power where you can - If an electrical outlet is available, use the AC/DC adapter and keep your battery(ies) charged.

Keep it dry - If you move quickly from a cold to a warm location, water vapor can condense inside the computer. Wait a few minutes before turning it on so that any moisture can evaporate.

Developing Good Work Habits

Developing good work habits is important if you need to work in front of the computer for long periods of time. Improper work habits can result in discomfort or serious injury from repetitive strain to your hands, wrists or other joints. The following are some tips to reduce the strain:



- Adjust the height of the chair and/or desk so that the keyboard is at or slightly below the level of your elbow. Keep your forearms, wrists, and hands in a relaxed position.
- Your knees should be slightly higher than your hips. Place your feet flat on the floor or on a footrest if necessary.
- Use a chair with a back and adjust it to support your lower back comfortably.
- Sit straight so that your knees, hips and elbows form approximately 90-degree angles when you are working.
- Take periodic breaks if you are using the computer for long periods of time.



Remember to:

- Alter your posture frequently.
- Stretch and exercise your body several times a day.
- Take periodic breaks when you work at the computer for long periods of time. Frequent and short breaks are better than fewer and longer breaks.

Lighting

Proper lighting and a comfortable viewing angle can reduce eye strain and shoulder and neck muscle fatigue.

- Position the display to avoid glare or reflections from overhead lighting or outside sources of light.
- Keep the display screen clean and set the brightness and contrast to levels that allow you to see the screen clearly.
- Position the display directly in front of you at a comfortable viewing distance.
- Adjust the display-viewing angle to find the best position.

LCD Screen Care

To prevent **image persistence** on LCD monitors (caused by the continuous display of graphics on the screen for an extended period of time) take the following precautions:

- Set the *Windows* **Power Plans** to turn the screen off after a few minutes of screen idle time.
- Use a rotating, moving or blank screen saver (this prevents an image from being displayed too long).
- Rotate desktop background images every few days.
- Turn the monitor off when the system is not in use.

LCD Electro-Plated Logos

Note that in computers featuring a raised LCD electro-plated logo, the logo is covered by a protective adhesive. Due to general wear and tear, this adhesive may deteriorate over time and the exposed logo may develop sharp edges. Be careful when handling the computer in this case, and avoid touching the raised LCD electro-plated logo. Avoid placing any other items in the carrying bag which may rub against the top of the computer during transport. If any such wear and tear develops contact your distributor/supplier.

Contents

Notice	I
ErP Off Mode Power Consumption Statement:	II
FCC Statement	IV
FCC RF Radiation Exposure Statement:	V
Instructions for Care and Operation	VII
Servicing	IX
Power Safety	X
Polymer Battery Precautions	XI
General Battery Precautions	XII
Cleaning	XIII
Servicing	XIII
Travel Considerations	XIV

Quick Start Guide

Overview	1-1
Advanced Users	1-2
Beginners and Non-Advanced Users	1-2
Warning Boxes	1-2
Not Included	1-3
System Startup	1-4
System Software	1-5

Preface

Model Differences	1-6
LCD Panel Open - Model A	1-7
LCD Panel Open - Model B	1-8
System Map: LCD Panel Open - Model C	1-9
LED Indicators	1-10
Keyboard - Model A	1-11
Keyboard - Models B & C	1-12
Keyboard Shortcuts	1-13
Function/Hot Key Indicators	1-14
Control Center	1-15
Front & Left Views - Model A	1-16
Front & Left Views - Model B	1-17
Front & Left Views - Model C	1-18
Right & Rear Views - Model A	1-19
Right & Rear Views - Model B	1-20
Right & Rear Views - Model C	1-21
Bottom View - Model A	1-23
Bottom View - Model B	1-24
Bottom View - Model C	1-25
Removing the Battery for Model B Computers	1-26
Removing the Battery for Model C Computers	1-27
Windows 8.1 Control Panel	1-28

Windows 8.1 Start Screen & Desktop1-31

Apps & Tiles1-32

Desktop Application1-33

The Charms Bar1-34

Windows 8.1 Taskbar1-36

Video Features1-37

Power Options1-40

Running Apps1-41

Features & Components

Overview2-1

Hard Disk Drive/Solid State Drive2-2

Optical (CD/DVD) Device2-3

Loading Discs2-3

Handling CDs or DVDs2-4

DVD Regional Codes2-5

Multi-In-1 Card Reader2-6

Touchpad and Buttons/Mouse2-7

Touchpad Sensitivity2-8

Synaptics TouchPad Configuration (for Models A & B)2-9

Gestures and Device Settings2-10

Elan TouchPad Configuration (for Model C)2-15

Preface

One-Finger	2-18
Multi-Finger	2-21
Additional	2-23
Audio Features	2-24
Setup for Audio Recording	2-25

Power Management

Overview	3-1
The Power Sources	3-2
AC/DC Adapter	3-2
Battery	3-2
Turning On the Computer	3-3
Shutting the Computer Down	3-4
Power Plans	3-5
Power-Saving States	3-7
Sleep	3-7
Hibernate	3-8
Shut down	3-8
Configuring the Power Buttons	3-9
Resuming Operation	3-11
Power Conservation Modes	3-12
Battery Information	3-14

Battery Power	3-14
Conserving Battery Power	3-15
Battery Life	3-16
New Battery	3-16
Recharging the Battery with the AC/DC Adapter	3-16
Proper handling of the Battery Pack	3-17
Battery FAQ	3-18
Intel® Dynamic Platform & Thermal Framework	3-22
Intel® DPTF Driver Installation	3-22
Configuring Intel® Dynamic Platform & Thermal Framework	3-23
Removing the Battery for Model B Computers	3-26
Removing the Battery for Model C Computers	3-27

Drivers & Utilities

What to Install	4-1
Module Driver Installation	4-1
Driver Installation	4-2
Updating/Reinstalling Individual Drivers	4-4
User Account Control	4-5
Windows Security Message	4-5
New Hardware Found	4-5
Driver Installation Procedure	4-6

Preface

Chipset	4-6
Video (VGA)	4-6
LAN	4-6
CardReader	4-6
Touchpad	4-6
Airplane	4-7
USB 3.0	4-7
Intel TXE	4-7
Hot Key	4-7
Intel® DPTF Driver Installation	4-7
Audio	4-7
Optional Drivers	4-8

BIOS Utilities

Overview	5-1
The Setup Utility	5-2
Failing the POST	5-3
Fatal Errors	5-3
Non-Fatal Errors	5-3
Setup Screens	5-4
Main Menu	5-5
Advanced Menu	5-7

Security Menu	5-10
Boot Menu	5-14
Exit Menu	5-16

Modules & Options

Overview	6-1
PC Camera Module	6-2
PC Camera Audio Setup	6-3
Camera App	6-4
Camera Options	6-5
Taking Pictures/Capturing Video	6-6
Camera Roll	6-7
Wireless LAN Module	6-11
3rd Party 802.11b/g/n Driver Installation	6-12
Intel® WLAN Driver Installation	6-12
WLAN Configuration in Windows	6-13
Bluetooth & WLAN Combo Module	6-16
3rd Party Bluetooth (V4.0) Combo Driver Installation	6-17
Intel Bluetooth Combo Driver Installation	6-17
Bluetooth Configuration in Windows	6-18
3G/4G Module	6-21
3G/4G Configuration in Windows	6-24

Preface

Trusted Platform Module	6-27
Enabling & Activating TPM	6-28
TPM Management in Windows	6-29
TPM Actions	6-31
Wireless Display	6-33
Wireless Display Configuration	6-34

Troubleshooting

Overview	7-1
Basic Hints and Tips	7-2
Backup and General Maintenance	7-3
Viruses	7-4
Upgrading and Adding New Hardware/Software	7-5
Problems and Possible Solutions	7-7
3G/4G Module PIN Code & Power-Saving	7-15
Resolving the “Insert a SIM” issue with the 3G/4G Module (Windows 8.1)	7-17

Interface (Ports & Jacks)

Overview	A-1
Notebook Ports and Jacks	A-2

Control Center

Overview	B-1
----------------	-----

Video Driver Controls

Intel Video Driver Installation	C-1
Dynamic Video Memory Technology	C-1
Intel® HD Graphics Control Panel	C-2
Display Devices & Options	C-16
Attaching Other Displays	C-17
Attaching Other Displays - Devices (Charms Bar)	C-19
Configuring an External Display In Windows	C-20
HDMI Audio Configuration	C-22

Specifications

Processors	D-2
Display	D-2
Memory	D-2
Video Adapter	D-2
Storage	D-2
Audio	D-2
Pointing Device & Keyboard	D-2
Interface	D-3
Card Reader	D-3
Slot	D-3
Communication	D-3

Preface

Power Management	D-3
Power & Battery	D-3
Security	D-4
Features	D-4
Operating System	D-4
Indicators	D-4
BIOS	D-4
Environmental Spec	D-4
Dimensions & Weight	D-4

Windows 10

Overview	E-1
Windows 10 Start Menu	E-2
Right-Clicking the Windows Logo In Start Menu	E-3
Start Menu Apps & Tiles	E-4
Pining/Unpinning Apps & Programs to/from the Start Menu	E-5
Windows 10 Control Panel	E-6
Settings	E-7
Windows 10 Taskbar	E-8
Video Features	E-9
To Configure Displays using Projectt	E-9
Power Options	E-12

Using the Power Button	E-12
Minimum Screen Resolution Settings	E-14
Windows 10 Drivers & Utilities	E-15
Driver Installation (Windows 10)	E-15
Driver Installation Procedure	E-17
Chipset	E-17
Video (VGA)	E-17
LAN	E-17
Card Reader	E-17
Touchpad	E-17
Airplane	E-18
Intel TXE	E-18
Control Center	E-18
Intel® DPTF Driver Installation	E-18
Audio	E-18
Optional Drivers	E-19
Wireless LAN Module	E-20
3rd Party WLAN Driver Installation	E-21
Intel® WLAN Driver Installation	E-21
Bluetooth & WLAN Combo Module	E-22
3rd Party Bluetooth Combo Driver Installation	E-23
Intel Bluetooth Combo Driver Installation	E-23

Preface

Bluetooth Configuration	E-24
PC Camera	E-25
3G/4G Module	E-26
3G/4G Configuration in Windows 10	E-27
Trusted Platform Module	E-28
TPM Management in Windows	E-28

Chapter 1: Quick Start Guide

Overview

This Quick Start Guide is a brief introduction to the basic features of your computer, to navigating around the computer and to getting your system started. The remainder of the manual covers the following:

- **Chapter 2** A guide to using some of the main features of the computer e.g. the **storage devices (hard disk, optical device, Multi-in-1 card reader), TouchPad & Mouse & Audio.**
- **Chapter 3** The computer's **power** saving options.
- **Chapter 4** The installation of the **drivers** and utilities essential to the operation or improvement of some of the computer's subsystems.
- **Chapter 5** An outline of the computer's built-in software or **BIOS** (Basic Input Output System).
- **Chapter 7** A quick guide to the computer's **PC Camera, Wireless LAN, Combo Bluetooth & WLAN, TPM (security), Intel and 3G/4G** modules (some of which may be **optional** depending on your purchase configuration).
- **Chapter 7** A **troubleshooting** guide.
- **Appendix A** Definitions of the **interface, ports/jacks** which allow your computer to communicate with external devices.
- **Appendix B** Information on **Control Center.**
- **Appendix C** Information on the **Video driver controls.**
- **Appendix D** The computer's **specification.**
- **Appendix E** A quick guide to **Windows 10** (including driver installation information).

Advanced Users

If you are an advanced user you may skip over most of this Quick Start Guide. However you may find it useful to refer to *“What to Install” on page 4 - 1* and *“BIOS Utilities” on page 5 - 1* in the remainder of the User’s Manual. You may also find the notes marked with a  of interest to you.

Beginners and Non-Advanced Users



Notes

Check the light colored boxes with the mark above to find detailed information about the computer’s features.

If you are new to computers (or do not have an advanced knowledge of them) then the information contained in the Quick Start Guide should be enough to get you up and running. Eventually you should try to look through all the documentation (more detailed descriptions of the functions, setup and system controls are covered in the remainder of the User’s Manual), but do not worry if you do not understand everything the first time. Keep this manual nearby and refer to it to learn as you go. You may find it useful to refer to the notes marked with a  as indicated in the margin. For a more detailed description of any of the interface ports and jacks see *“Interface (Ports & Jacks)” on page A - 1*.

Warning Boxes

No matter what your level please pay careful attention to the warning and safety information indicated by the  symbol. Also please note the safety and handling instructions as indicated in the *Preface*.

Not Included

Operating Systems (e.g. *Windows 8.1*) and applications (e.g. word processing, spreadsheet and database programs) have their own manuals, so please consult the appropriate manuals.



Drivers

If you are installing new system software, or are re-configuring your computer for a different system, you will need to install the drivers listed in ***“Drivers & Utilities” on page 4 - 1***. Drivers are programs which act as an interface between the computer and a hardware component e.g. a wireless network module. It is very important that you install the drivers in the order listed. You will be unable to use most advanced controls until the necessary drivers and utilities are properly installed. If your system hasn't been properly configured (your service representative may have already done that for you); refer to ***Chapter 4*** for installation instructions.

Ports and Jacks

See ***“Interface (Ports & Jacks)” on page A - 1*** for a description of the interface (ports & jacks) which allow your computer to communicate with external devices, connect to the internet etc.

System Startup

1. Remove all packing materials, and place the computer on a stable surface.
2. Securely attach any peripherals you want to use with the notebook (e.g. keyboard and mouse) to their ports.
3. Attach the AC/DC adapter to the DC-In jack on the left of the computer, then plug the AC power cord into an outlet, and connect the AC power cord to the AC/DC adapter (**make sure you use the adapter when first setting up the computer**, as to safeguard the computer during shipping the battery will be locked to not power the system until first connected to the AC/DC adapter).
4. Use one hand to raise the lid/LCD to a comfortable viewing angle (**do not exceed 130 degrees**); use the other hand to support the base of the computer (**Note: Never** lift the computer by the lid/LCD).

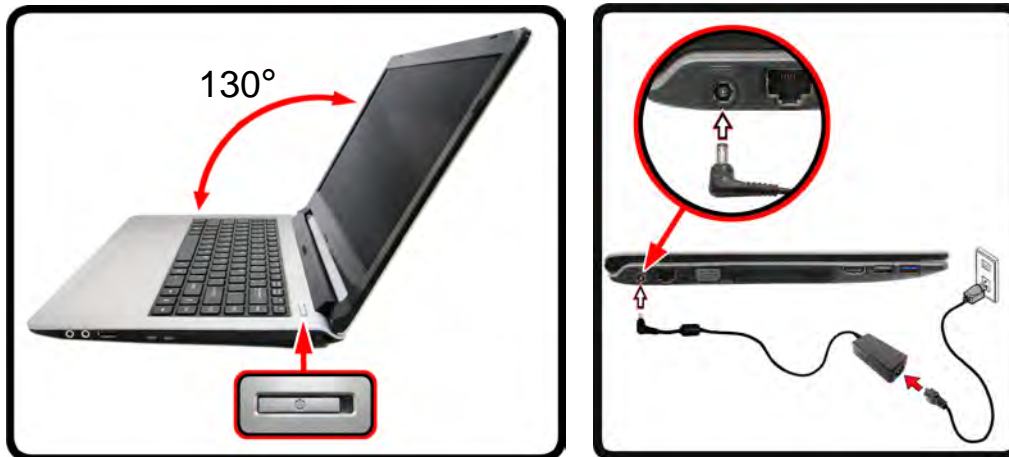

Shutdown

Note that you should always shut your computer down by choosing the **Shut Down** command in **Windows** (see page 1 - 40). This will help prevent hard disk or system problems.

Figure 1 - 1 - Opening the Lid/LCD & Computer with AC/DC Adapter Plugged-In (One Model Pictured)

System Software

Your computer may already come with system software pre-installed. Where this is not the case, or where you are re-configuring your computer for a different system, you will find the **Windows 8.1** operating system is supported.

Note: In order to run **Windows** without limitations or decreased performance, your computer requires a minimum **1GB** of system memory (RAM).



Windows Versions

Note that the information included on the following pages is for **Windows 8.1 (64-bit) only**.

Windows OS

In order to run **Windows 8.1 (64-bit)** without limitations or decreased performance, your computer requires a minimum **2GB** of system memory (RAM).

Quick Start Guide

Model Differences

This notebook series includes **three** different models that vary slightly in design style, color and general appearance. Not all the model variants, colors, configurations, buttons etc., are pictured in this manual. Note that though your computer may look slightly different from that pictured throughout this manual, all ports, jacks (other than those indicated below and in specification) and general functions are the same for all the design styles (see [Appendix D](#) for further details).

Feature	Model A	Model B	Model C
Display	14.0" / 35.56cm HD (1366 * 768), 16:9 3.6mm Thick Backlit Panel	15.6" / 39.62cm HD (1366 * 768), 16:9 3.8mm Thick Backlit Panel	17.3" / 43.94cm HD+ (1600 * 900), 16:9 6.0mm Thick Backlit Panel
Keyboard	A4 Size Isolated Keyboard	Full Size Isolated Winkey Keyboard with Numeric Keypad	
USB 2.0 Ports	One USB 2.0 Port	Two USB 2.0 Ports	
M.2 Card Slot	Two M.2 Slots		One M.2 Slot
3G/4G Module	Supported		Not Supported
See "Storage" on page D - 2 , "Communication" on page D - 3 , "Power & Battery" on page D - 3 & "Dimensions & Weight" on page D - 4			

Table 1 - 1 - Model Differences

LCD Panel Open - Model A





**Wireless Device
Operation Aboard
Aircraft**

The use of any portable electronic transmission devices aboard aircraft is usually prohibited. Make sure the **WLAN, Bluetooth & 3G/4G module(s) are OFF** if you are using the computer aboard aircraft by putting the system in to **Airplane Mode** (see [Table 1 - 4, on page 1 - 14](#)).

Figure 1 - 2
LCD Panel Open
Model A

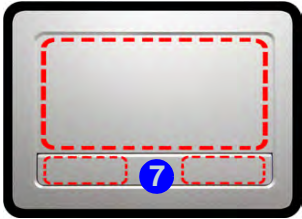
1. Built-in PC Camera
2. PC Camera LED
3. Built-In Microphone
4. LCD*
5. Power Button
6. Keyboard
7. Touchpad & Buttons



Note that the Touchpad and Buttons has a valid operational area indicated within the dotted lines above.

Figure 1 - 3
LCD Panel Open
Model B

1. Built-in PC Camera
2. PC Camera LED
3. Built-In Microphone
4. LCD
5. Power Button
6. Keyboard
7. Touchpad & Buttons

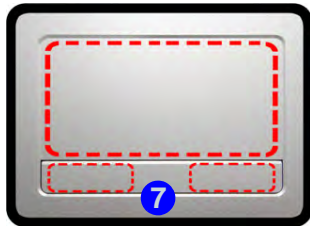

Note that the Touchpad and Buttons has a valid operational area indicated within the dotted lines above.

LCD Panel Open - Model B



Wireless Device Operation Aboard Aircraft

The use of any portable electronic transmission devices aboard aircraft is usually prohibited. Make sure the **WLAN, Bluetooth & 3G/4G** are **OFF** if you are using the computer aboard aircraft by putting the system in to **Airplane Mode** (see [Table 1 - 4, on page 1 - 14](#)).

System Map: LCD Panel Open - Model C





**Wireless Device
Operation Aboard
Aircraft**

The use of any portable electronic transmission devices aboard aircraft is usually prohibited. Make sure the **WLAN & Bluetooth module(s)** are **OFF** if you are using the computer aboard aircraft by putting the system in to **Airplane Mode** (see [Table 1 - 4, on page 1 - 14](#)).

Figure 1 - 4
LCD Panel Open
Model C

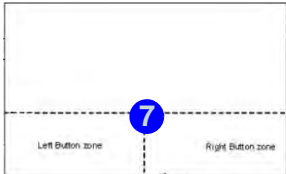
1. Built-in PC Camera
2. PC Camera LED
3. Built-In Microphone
4. LCD
5. Power Button
6. Keyboard
7. Touchpad/Clickpad & Buttons



Note that the Touchpad/Clickpad and Buttons has a valid operational area indicated within the dotted lines above.

LED Indicators

The LED indicators on the computer display helpful information about the current status of the computer.





Icon	Color	Description
	Orange	DC Power is Plugged In
	Green	The Computer is On
	Blinking Green	The Computer is in Sleep Mode
	Orange	The Battery is Charging
	Green	The Battery is Fully Charged
	Blinking Orange	The Battery Has Reached Critically Low Power Status
	Green	Airplane Mode is ON (the WLAN, Bluetooth & 3G/4G Modules are OFF)
	Green	Hard Disk Activity

Table 1 - 2 - LED Indicators

Keyboard - Model A

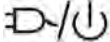
The keyboard has an embedded numerical keypad for easy numeric data input, and function keys to change operational features instantly.

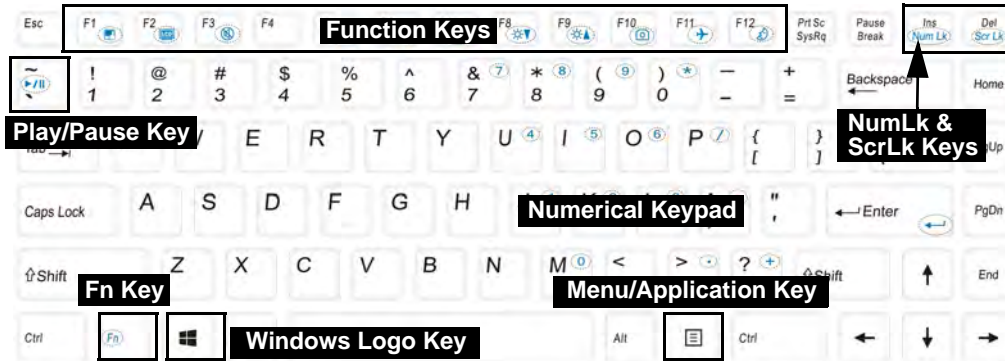

Figure 1 - 5 - Keyboard - Model A

Special Characters

Some software applications allow the number-keys to be used with **Alt** to produce special characters. These special characters can only be produced by using the numeric keypad. Regular number keys (in the upper row of the keyboard) will not work. Make sure that **NumLk** is on.



Other Keyboards

If your keyboard is damaged or you just want to make a change, you can use any standard USB keyboard. The system will detect and enable it automatically. However special functions/hot-keys unique to the system's regular keyboard may not work.

NumLk & ScrLk

Hold down the **Fn Key** and either **NumLk** or **ScrLk** to enable number or scroll lock, and check the LED indicator for status.



Other Keyboards

If your keyboard is damaged or you just want to make a change, you can use any standard USB keyboard. The system will detect and enable it automatically. However special functions/hot-keys unique to the system's regular keyboard may not work.

NumLk & ScrLk

Hold down the **Fn Key** and either **NumLk** or **ScrLk** to enable number or scroll lock, and check the LED indicator for status.

Keyboard - Models B & C

The keyboard has a numerical keypad for easy numeric data input, and function keys to change operational features instantly.

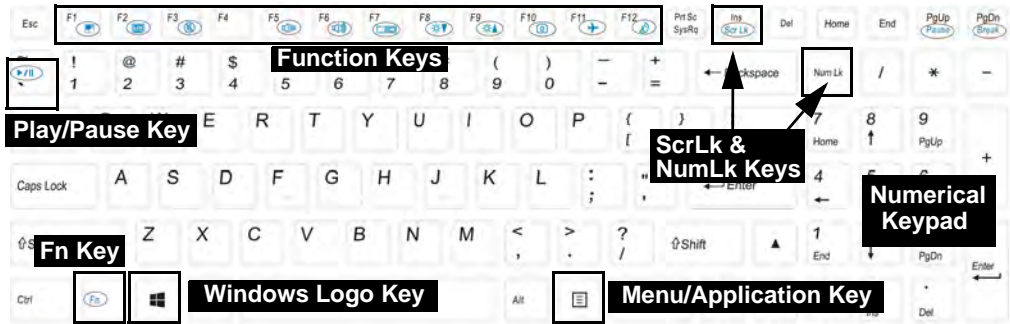

Figure 1 - 6 - Keyboard - Models B & C



Special Characters

Some software applications allow the number-keys to be used with **Alt** to produce special characters. These special characters can only be produced by using the numeric keypad. Regular number keys (in the upper row of the keyboard) will not work. Make sure that **NumLk** is on.

Keyboard Shortcuts

The following Windows Logo Key (Winkey) keyboard shortcuts are useful for navigation/operation in *Windows 8.1*.



Windows Logo  Key +	Description
Tap Winkey	Toggle between the Start screen and the foremost running app or the Windows Desktop
C	Display Charms menu
D	Switch to the Windows Desktop and toggle show Desktop
E	Switch to the Windows desktop and launch Windows Explorer with Computer displayed
F	Display file Search
I	Open the Settings charm
K	Open the Connect charm
L	Lock the computer and display the Lock screen
P	Display the Second Screen menu (see Figure 1 - 27 on page 1 - 37)
R	Switch to the Windows Desktop and display the Run dialog box
Z	Access the Customize Bar (see Figure 1 - 22 on page 1 - 32)

Table 1 - 3 - Keyboard Shortcuts



Windows Logo Keyboard Shortcut

Use the Windows logo key  + **D** key combination to switch from the Start screen to the Windows Desktop.

Menu/Application Keyboard Shortcut

When the Desktop app is running you can use the Menu/Application key  on the keyboard to act as a mouse right-click. In the Start screen this function is useful to quickly display **Customize Apps**.

Function/Hot Key Indicators

The **function keys** (F1 - F12 etc.) will act as **hot keys** when pressed while the **Fn** key is held down. In addition to the basic function key combinations; visual indicators are available when the hot key utility is installed.















Keys	Function	Keys	Function
Fn + 	Play/Pause (in Audio/Video Programs)	Fn +  	Brightness Decrease/Increase
Fn + 	Fan Control Toggle Automatic Fan Control / Full Power	Fn + 	PC Camera Power Toggle
Fn + 	TouchPad Toggle	Fn + 	Airplane Mode Toggle
Fn + 	Turn LCD Backlight Off (Press a key to or use TouchPad to turn on)	Fn + 	Sleep Toggle
Fn + 	Mute Toggle	Fn + NumLk	Number Lock Toggle
Fn +  	Volume Decrease/Increase	Fn + ScrLk	Scroll Lock Toggle
Fn + 	Display Toggle	Caps Lock	Caps Lock Toggle
Fn + Esc	Control Center Toggle		

Table 1 - 4 - Function & Hot Key Indicators

Control Center

When in the **Windows Desktop application** (not in the **Start** screen) press the **Fn + Esc** key combination, or **double-click the icon**  in the **notification area of the taskbar** to toggle the **Control Center** on/off. The **Control Center** gives quick access to frequently used controls and enables you to quickly turn the camera/touch pad on/off (see [Appendix B](#) for full details).



Control Center Access

To run the Control Center press the **Fn + Esc** key combination, or double-click the icon  in the notification area of the taskbar.

Close the Control Center by clicking the  close icon in the top right of the panel (move the cursor onto the top right corner of the panel to highlight it).

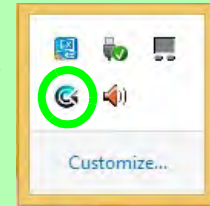

Figure 1 - 7 - Control Center

Quick Start Guide

Figure 1 - 8
Front & Left Views
Model A

1. LED Indicators
2. Multi-in-1 Card Reader
3. DC-In Jack
4. RJ-45 LAN Jack
5. External Monitor Port
6. Vent/Fan Intake/Outlet
7. HDMI-Out Port
8. USB 3.0 Ports

Front & Left Views - Model A



Multi-In-1 Card Reader

The card reader allows you to use the most popular digital storage card formats:

MMC (MultiMedia Card) / RS MMC
SD (Secure Digital) / Mini SD / SDHC / SDXC
MS (Memory Stick) / MS Pro / MS Duo

USB 3.0 Port OR USB 2.0 Port

This model includes 2 * USB 3.0 ports and 1* USB 2.0 port. The USB 3.0 ports are denoted by their **blue color**; the USB 2.0 port is colored black.

Front & Left Views - Model B



Figure 1 - 9
**Front & Left Views
Model B**

1. LED Indicators
2. Multi-in-1 Card Reader
3. DC-In Jack
4. RJ-45 LAN Jack
5. External Monitor Port
6. Vent/Fan Intake/Outlet
7. HDMI-Out Port
8. USB 3.0 Ports



Multi-In-1 Card Reader

The card reader allows you to use the most popular digital storage card formats:

MMC (MultiMedia Card) / RS MMC
SD (Secure Digital) / Mini SD / SDHC / SDXC
MS (Memory Stick) / MS Pro / MS Duo

USB 3.0 Port OR USB 2.0 Port

This model includes 2 * USB 3.0 ports and 2 * USB 2.0 ports. The USB 3.0 ports are denoted by their **blue color**; the USB 2.0 ports are colored black.

Figure 1 - 10
Front & Left Views
Model C

1. LED Indicators
2. DC-In Jack
3. RJ-45 LAN Jack
4. External Monitor Port
5. Vent/Fan Intake/Outlet
6. HDMI-Out Port
7. USB 3.0 Ports
8. Multi-in-1 Card Reader

Front & Left Views - Model C



Multi-In-1 Card Reader

The card reader allows you to use the most popular digital storage card formats:

MMC (MultiMedia Card) / RS MMC
 SD (Secure Digital) / Mini SD / SDHC / SDXC

USB 3.0 Port OR USB 2.0 Port

This model includes 2 * USB 3.0 ports and 2 * USB 2.0 ports. The USB 3.0 ports are denoted by their **blue color**; the USB 2.0 ports are colored black.

Right & Rear Views - Model A



Figure 1 - 11
Right & Rear Views
Model A

1. Microphone-In Jack
2. Headphone-Out Jack
3. USB 2.0 Port
4. Optical Device Drive Bay (for CD/DVD Device)
5. Security Lock Slot

Battery Information

Always completely discharge, then fully charge, a new battery before using it. Completely discharge and charge the battery at least once every 30 days or after about 20 partial discharges. See [“Battery Information” on page 3 - 14](#) for full instructions. This model's battery is embedded and cannot be removed without violating the terms of your warranty. Contact your distributor/supplier for details.

USB 3.0 Port OR USB 2.0 Port

This model includes 2 * USB 3.0 ports and 1* USB 2.0 port. The USB 3.0 ports are denoted by their **blue color**; the USB 2.0 port is colored black.

Figure 1 - 12
Right & Rear Views
Model B

1. Microphone-In Jack
2. Headphone-Out Jack
3. USB 2.0 Ports
4. Optical Device Drive Bay (for CD/DVD Device)
5. Security Lock Slot
6. Battery

Right & Rear Views - Model B



Battery Information

Always completely discharge, then fully charge, a new battery before using it. Completely discharge and charge the battery at least once every 30 days or after about 20 partial discharges. See [“Battery Information” on page 3 - 14](#) for full instructions.

USB 3.0 Port OR USB 2.0 Port

These models include 2 * USB 3.0 ports and 2 * USB 2.0 ports. The USB 3.0 ports are denoted by their **blue color**; the USB 2.0 ports are colored black.

Right & Rear Views - Model C



Figure 1 - 13
Right & Rear Views
Model C

1. Microphone-In Jack
2. Headphone-Out Jack
3. USB 2.0 Port
4. Optical Device Drive Bay (for CD/DVD Device)
5. Security Lock Slot
6. Battery



Battery Information

Always completely discharge, then fully charge, a new battery before using it. Completely discharge and charge the battery at least once every 30 days or after about 20 partial discharges. See [“Battery Information” on page 3 - 14](#) for full instructions.

USB 3.0 Port OR USB 2.0 Port

This model includes 2 * USB 3.0 ports and 2 * USB 2.0 ports. The USB 3.0 ports are denoted by their **blue color**; the USB 2.0 ports are colored black.



Disk Eject Warning

Don't try to eject a CD/DVD while the system is accessing it. This may cause the system to "crash". Stop the disk first then eject it, or press the stop button twice.

CD/DVD Emergency Eject

If you need to manually eject a CD/DVD (e.g. due to an unexpected power interruption) you may push the end of a straightened paper clip into the emergency eject hole. Do not use a sharpened pencil or any object that may break and become lodged in the hole. Don't try to remove a floppy disk/CD/DVD while the system is accessing it. This may cause the system to "crash".



Changing DVD Regional Codes

Go to the **Control Panel** and double-click **Device Manager (Hardware and Sound)**, then click the **+** next to **DVD/CD-ROM drives**. Double-click on the DVD-ROM device to bring up the **Properties** dialog box, and select the **DVD Region** (tab) to bring up the control panel to allow you to adjust the regional code (see "[DVD Regional Codes](#)" on page 2 - 5).

DVD region detection is device dependent, not OS-dependent. You can select your module's region code **5** times. The fifth selection is permanent. This cannot be altered even if you change your operating system or you use the module in another computer.

Bottom View - Model A

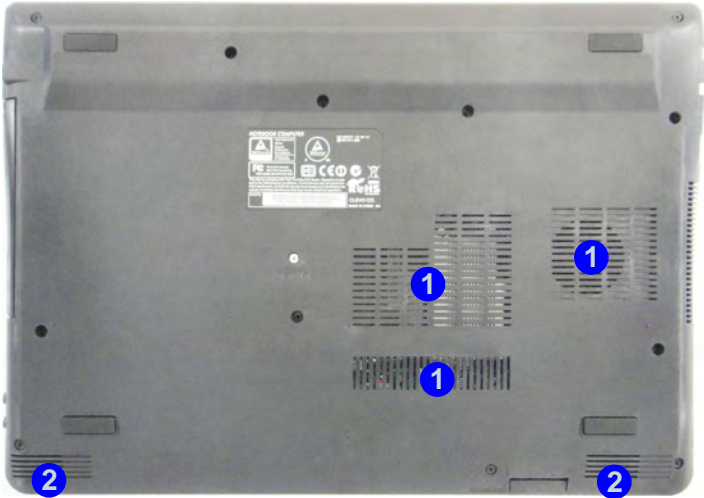



Figure 1 - 14
Bottom View
Model A

- 1. Vent/Fan Intake/Outlet
- 2. Speakers



Bottom Cover Removal Warning

Do not remove any cover(s) and /or screw(s) for the purposes of device upgrade as this may violate the terms of your warranty.

If you need to replace/remove the hard disk/RAM/optical device etc., for any reason, please contact your distributor/supplier for further information.



Overheating

To prevent your computer from overheating make sure nothing blocks the Vent/Fan Intake while the computer is in use.

Quick Start Guide

Figure 1 - 15
Bottom View
Model B

1. Battery
2. Vent/Fan Intake/
Outlet
3. Speakers

Bottom View - Model B

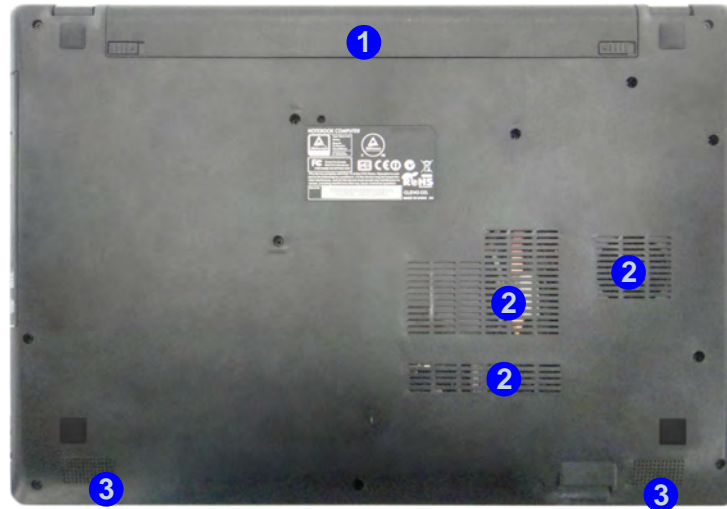

Bottom Cover Appearance

Note that some design styles will have a bottom cover that differs in appearance slightly from that pictured here.

Overheating

To prevent your computer from overheating make sure nothing blocks the Vent/Fan Intake while the computer is in use.



Bottom Cover Removal Warning

Do not remove any cover(s) and /or screw(s) for the purposes of device upgrade as this may violate the terms of your warranty.

If you need to replace/remove the hard disk/RAM/optical device etc., for any reason, please contact your distributor/supplier for further information.

Bottom View - Model C

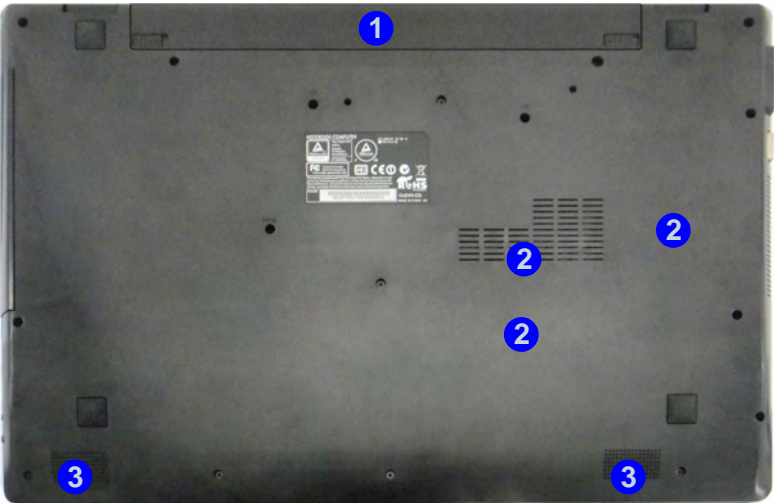

Figure 1 - 16
Bottom View
Model C

- 1. Battery Location
- 2. Vent/Fan Intake/Outlet
- 3. Speakers



Bottom Cover Removal Warning

Do not remove any cover(s) and /or screw(s) for the purposes of device upgrade as this may violate the terms of your warranty.
If you need to replace/remove the hard disk/RAM/optical device etc., for any reason, please contact your distributor/supplier for further information.



Overheating

To prevent your computer from overheating make sure nothing blocks the Vent/Fan Intake while the computer is in use.



Bottom Cover Removal Warning

Do not remove any cover(s) and /or screw(s) for the purposes of device upgrade as this may violate the terms of your warranty.

If you need to replace/remove the hard disk/RAM/optical device etc., for any reason, please contact your distributor/supplier for further information.

Figure 1 - 17
Battery Removal
Model B Computers

Removing the Battery for Model B Computers

We recommend that you do not remove the battery yourself. If you do need to remove the battery for any reason (e.g. long term storage) see below.

1. Turn the computer **off**, and turn it over.
2. Slide the latch **1** in the direction of the arrow.
3. Slide the latch **2** in the direction of the arrow, and hold it in place.
4. Slide the battery out in the direction of the arrow **3**.
5. Reinsert the battery as illustrated below **4**.
6. Make sure the latches are returned to the lock position **5**.

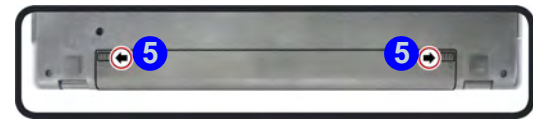
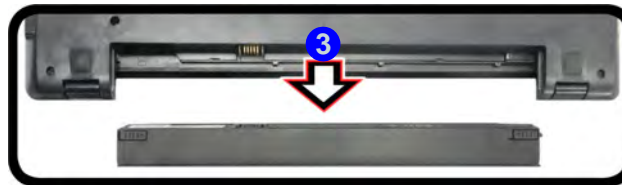

Removing the Battery for Model C Computers

We recommend that you do not remove the battery yourself. If you do need to remove the battery for any reason (e.g. long term storage) see below.

1. Turn the computer **off**, and turn it over.
2. Slide the latch **1** in the direction of the arrow.
3. Slide the latch **2** in the direction of the arrow, and hold it in place.
4. Slide the battery out in the direction of the arrow **3**.
5. See over for inserting the battery instructions.

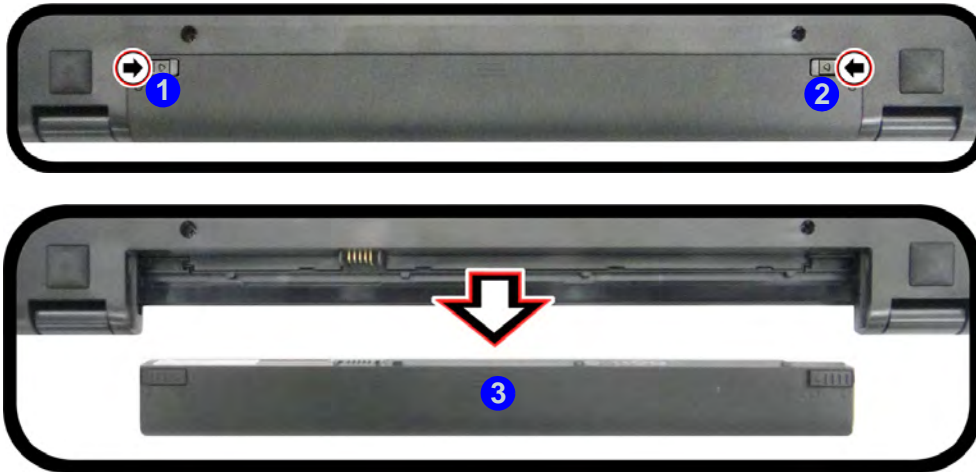

Bottom Cover Removal Warning

Do not remove any cover(s) and /or screw(s) for the purposes of device upgrade as this may violate the terms of your warranty.

If you need to replace/remove the hard disk/RAM/optical device etc., for any reason, please contact your distributor/supplier for further information.

Figure 1 - 18
Battery Removal
Model C Computers



Windows Versions

Note that the information included on the following pages is for the latest updated version of **Windows 8.1 only**.

Make sure you enable **Windows Update** in order to get all the latest security updates etc. (see **“Windows Update” on page 4 - 8**).

Windows 8.1 Control Panel

Throughout this manual you will see an instruction to open the **Control Panel**. Right-click the lower left hot corner to bring up the context menu (or use the **Windows Logo Key**  + **X** key combination) and select **Control Panel** in both the **Desktop app** or **Start screen**.

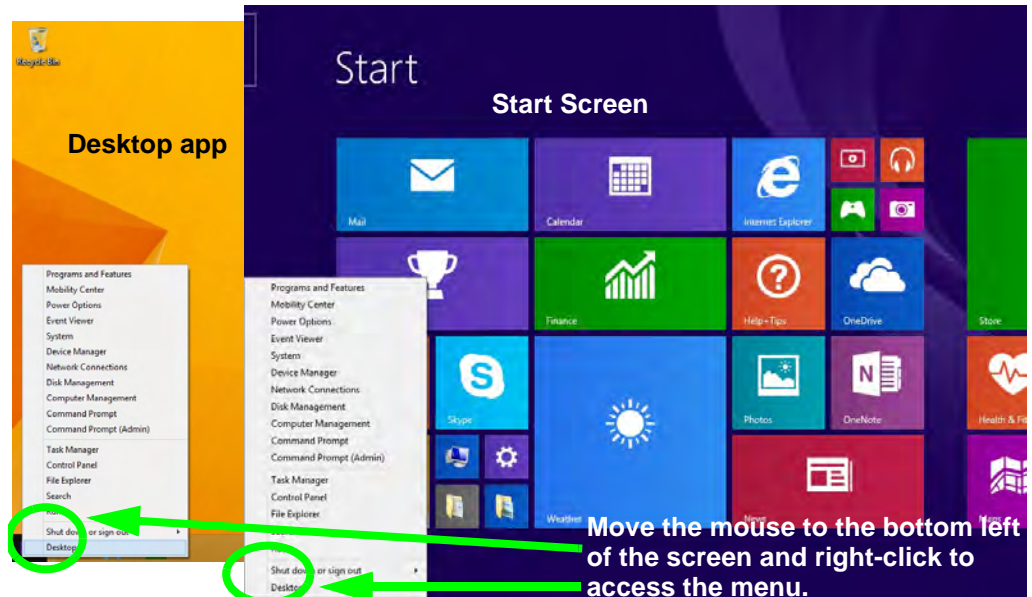



Figure 1 - 19 - Windows Context Menu

The Control Panel can be accessed in a number of ways in *Windows 8.1*.

- Click **Search** in the **Windows Charms Bar** (see previous page) and the search pane will pop out. Type *Control Panel* and select it from the results to the left.
- Click on **This PC (in Apps, or you can to pin This PC to the Start screen)**, click on **Computer** in the top menu and select **Open Control Panel** from the ribbon.
- When in the **Desktop** app (this does not apply to the Start screen) click on **Settings** in the **Windows Charms Bar** and select **Control Panel** from the menu.
- **Click the arrow at the bottom of the Start screen** and click **Control Panel** in **Apps (Windows System)**.
- Right-click the **Start** button to bring up the menu and select Control Panel (see *Figure 1 - 20 on page 1 - 30*).



Keyboard Shortcut to Control Panel

You can also use keyboard shortcuts to access the Control Panel. Press the **Windows logo key**  and **X** to bring up the context menu, and then press **P** to bring up the Control Panel. Alternatively press the **Windows logo key**  and **R** to bring up the **Run** dialog box, and then type "**Control Panel**" and press Enter to access the Control Panel.

Quick Start Guide



Display Most Recently Used Apps

If you are in the **Start** screen, **Desktop** or an app you can move your mouse to the upper left corner of the screen to get back to the most recently used app.

To view all the most recently used Apps hover over the top left of the screen and then move the mouse down along the left side of the screen to display the list.

Right-click the **Start button** in the **Desktop** app (or use the **Windows Logo Key** + **X** key combination) to bring up an advanced context menu of useful features such as Control Panel, Programs and Features, Power Options, Task Manager, Search, File Explorer, Command Prompt, Device Manager and Network Connections etc.

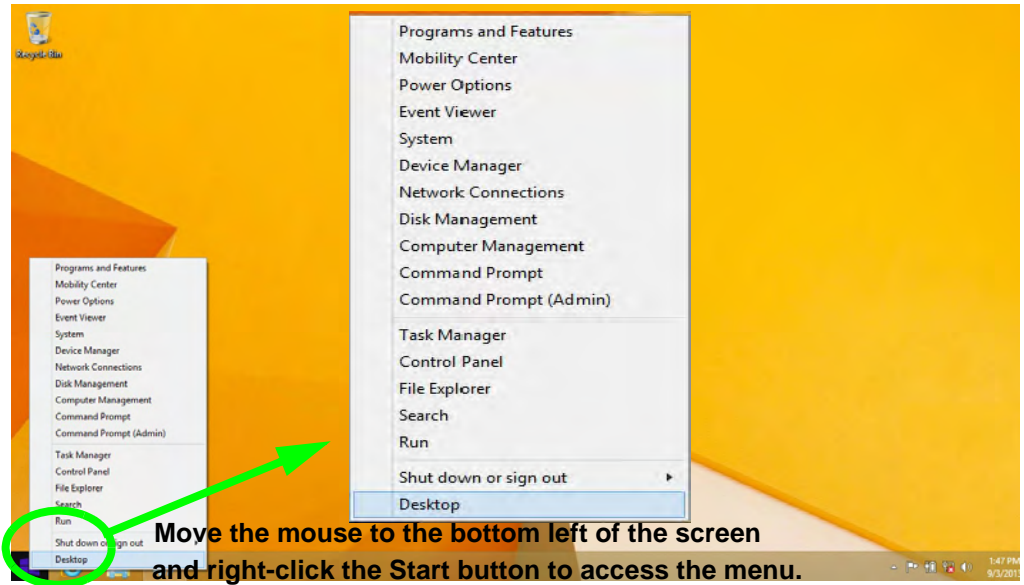



Figure 1 - 20 - Advanced Context Menu (Right-Click Start Button)

Windows 8.1 Start Screen & Desktop

The Apps, control panels, utilities and programs within *Windows* are accessed from the **Start screen** and/or **Windows Desktop app**. The **Desktop** (which runs as an app within the **Start screen**) can be accessed by clicking the **Desktop** item in the **Start screen** (or by using the **Windows Logo Key**  + **D** key combination). Click the arrow at the bottom of the **Start screen** to access **Apps**.

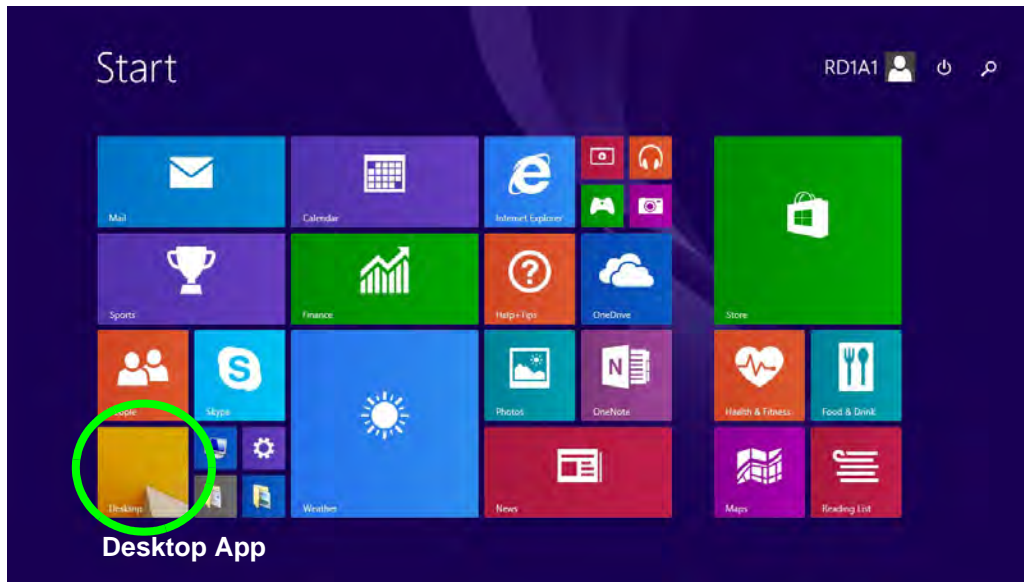

Figure 1 - 21 - Windows Start Screen

Quick Start Guide

Apps & Tiles

The **Start** screen will contain a number of apps, and many more will be installed as you add more applications etc. Not all of these apps can fit on one screen so you will often need use the **slider** at the bottom of the screen in order to view all the necessary Apps.

Accessing Pining/Unpinning All Apps

You can add and remove the tiles for apps and control panels in the **Start screen**. **Right-click** on an app to bring up the context menu and you **pin the App** to (or unpin from) the **Start** screen, or to the **taskbar**.

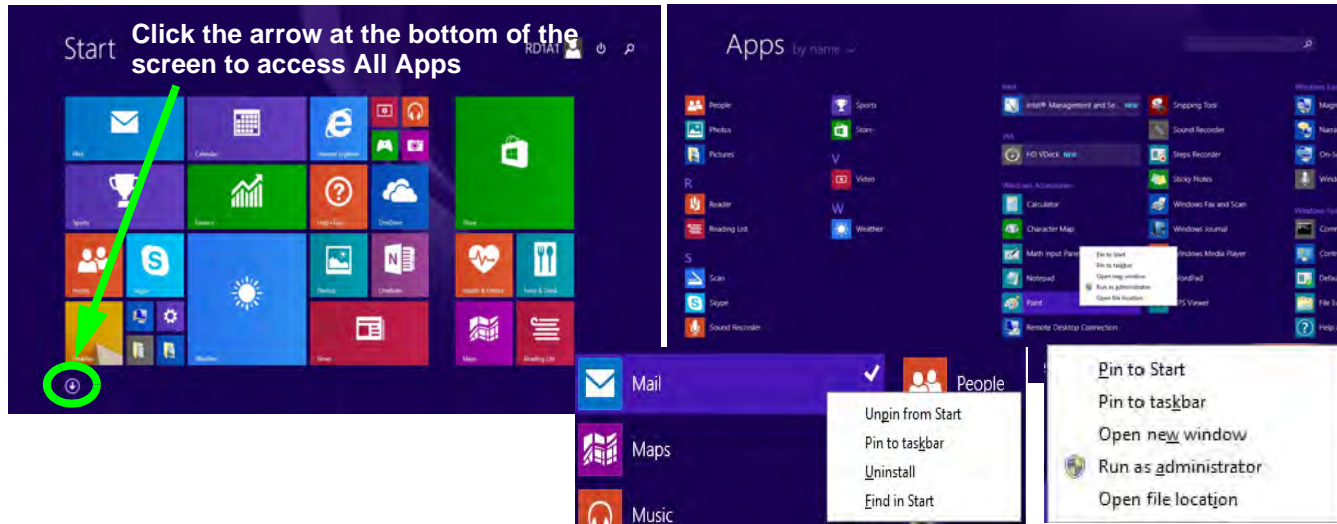



Figure 1 - 22 - Apps

Desktop Application

When the **Desktop** app is running (click the app in the **Start** screen or use the **Windows Logo Key**  + **D** key combination) you can use lower left hot corner to switch between the **Start** screen and the **Windows Desktop** app. To do so move your mouse to hover over the bottom left corner of the **Desktop** app and left-click.

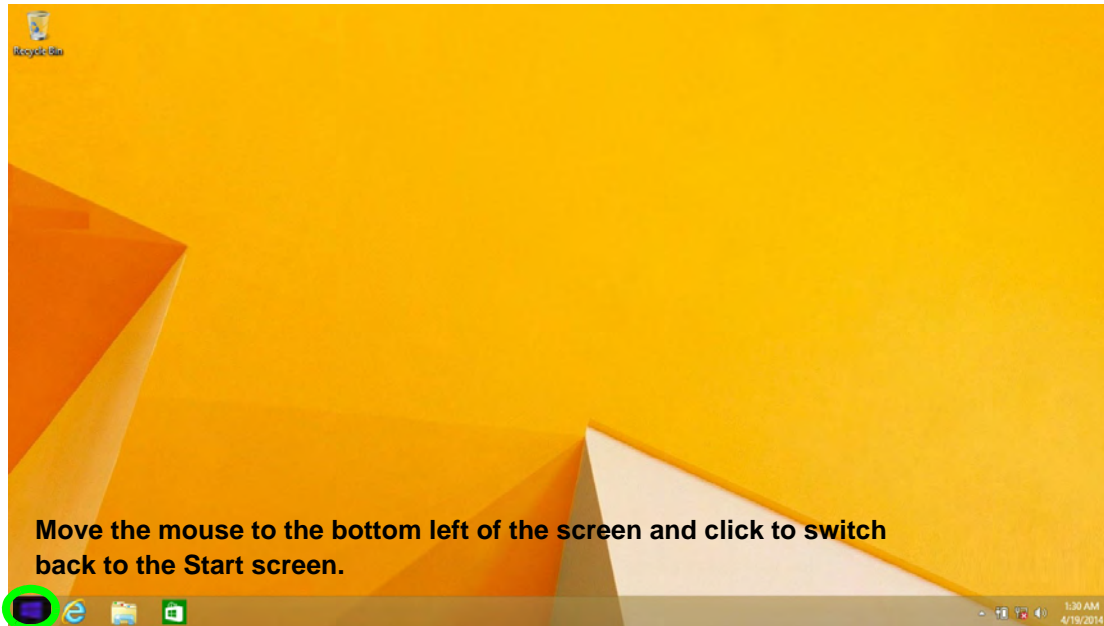



Figure 1 - 23 - Desktop

The Charms Bar

The right side of the screen (Start or Desktop) displays the **Charms Bar**. The **Charms Bar** contains the **Search**, **Share**, **Start**, **Devices** and **Settings** menus. To access up the **Charms Bar** move the cursor to the upper or lower right corners of the screen, and then hover over one of the items in the **Charms Bar** to activate it (the bar will be black when it is active), or use the **Windows Logo Key**  + **C** key combination.

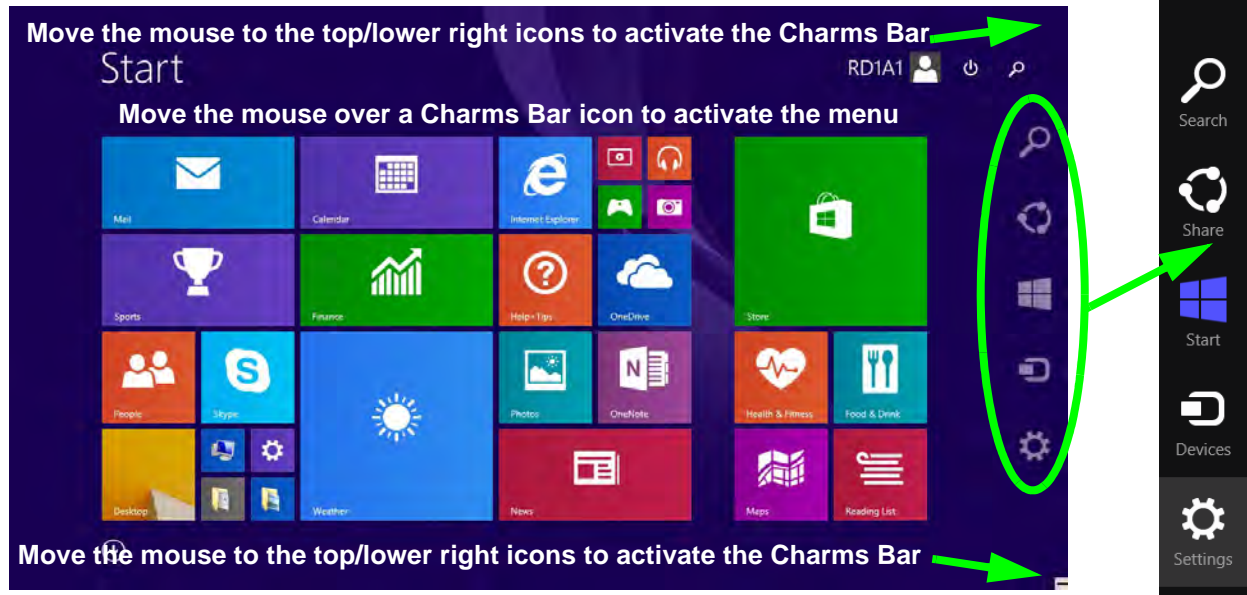





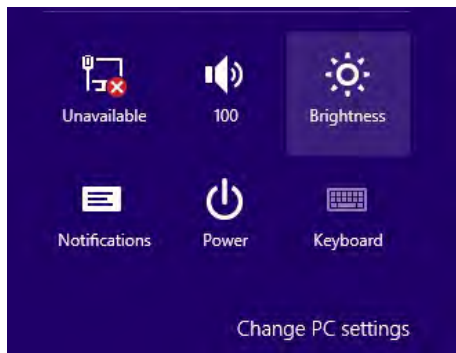

Figure 1 - 24 - Start Screen with Charms Bar

Charms Bar Items

- **Search** : You can search for any file, application, Apps and control panel settings with instantaneous results.
- **Share** : This button is used to share information with people via mail or social networks.
- **Start** : Click to bring up the **Start** screen (the same function as pressing the Windows Logo Key or clicking the bottom left of the screen).
- **Devices** : Click this button to change connected peripheral device settings e.g. an external display.
- **Settings** : This button gives instant access to the computer settings, such as Network, Audio, Notifications, Power and Keyboard (click **Change PC Settings** to activate the PC Settings menu).



Charms Bar - TouchPad Access

To quick access the **Charms Bar** using the TouchPad:

1. Place your finger **off** the TouchPad (slightly to the right of the pad resting on the computer).
2. Move your finger across to the left on to the TouchPad.
3. The Charms Bar will then pop-up.

Figure 1 - 25 - Settings Menu

Windows 8.1 Taskbar

In many instances throughout this manual you will see an instruction to access the **notification area of the taskbar (system tray)**. In *Windows 8.1* the taskbar can be directly accessed from the **Desktop** application; if you are in the **Start** screen you will need to move the cursor to the bottom of the screen to display the taskbar.

The taskbar is displayed at the bottom of the screen, and you can see the **notification area (system tray)** of the taskbar in the bottom right of the screen. Some of the control panels and applications referred to during the course of this manual can be accessed from here.

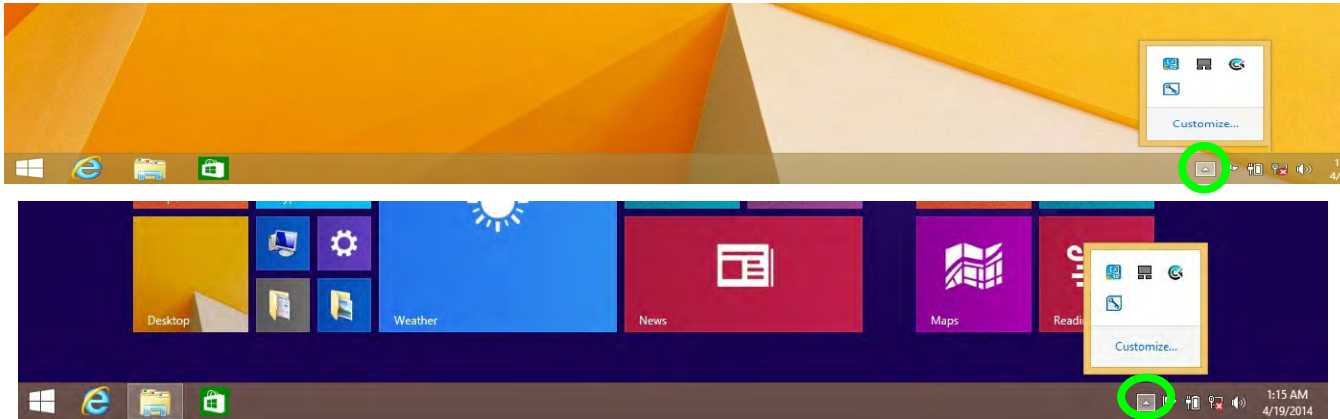

Figure 1 - 26 - Taskbar & Notification Area (System Tray)

You can pin/unpin apps to/from the taskbar in much the same way as you can to the **Start** screen (see *“Accessing Pining/Unpinning All Apps” on page 1 - 32*).

Video Features

You can switch display devices, and configure display options, from the **Display** control panel (in **Appearances and Personalization**) in *Windows* when running the **Desktop** app (see *“Desktop Application” on page 1 - 33* and *Appendix C*). It is possible to quickly configure external displays from the **Devices** menu item in the **Charms Bar** (see *“The Charms Bar” on page 1 - 34*).

To Configure Displays from Devices (Charms Bar):

1. Attach your display to the appropriate port, and turn it on.
2. Go the **Charms Bar**, select **Devices**.
3. Click **Project** (you may need to click **Second Screen**).
4. Click on any one of the options from the menu to select **PC screen only**, **Duplicate**, **Extend** or **Second screen only**.

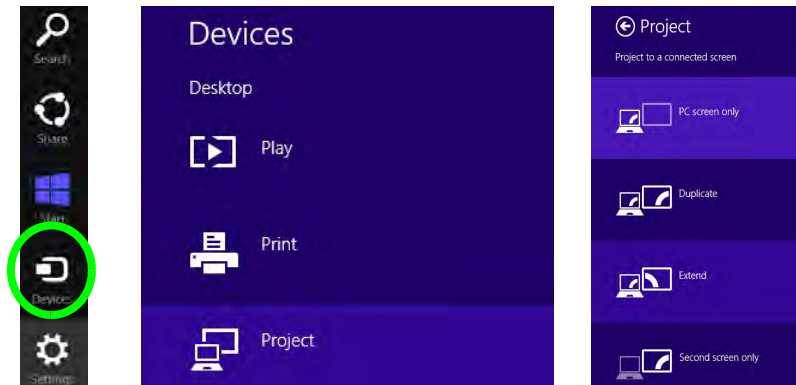

Figure 1 - 27- Devices (Project)

Quick Start Guide

To access **Display (Control Panel) and Screen Resolution** in *Windows 8*:

1. Go to the **Control Panel**.
2. Click **Display** (icon) - In the **Appearance and Personalization** category.
3. **Adjust resolution.**

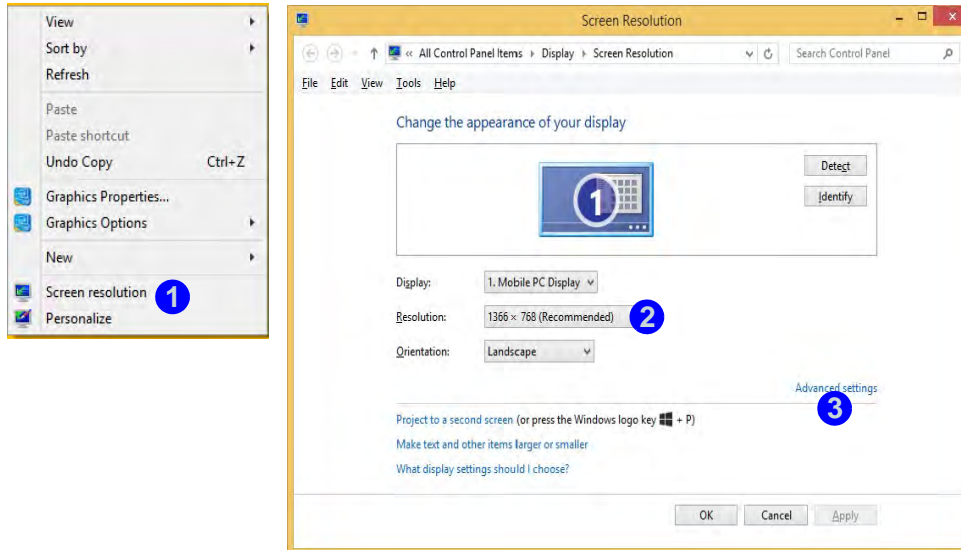

Figure 1 - 28 - Screen Resolution



Right-Click Desktop App

1. You can right-click the desktop and select **Screen resolution** ① (*Figure 1 - 28*).
2. Use the dropdown to select the screen **Resolution** ② (*Figure 1 - 28*).
3. Click **Advanced settings** ③ (*Figure 1 - 28*) to bring up the **Advanced** properties tabs.

To access the *Intel(R) HD Graphics Control Panel*:

1. Click **Advanced settings** ③ (*Figure 1 - 28 on page 1 - 38*) in the **Screen Resolution** control panel in **Windows**.

2. Click the **Intel(R)...** tab and click **Graphics Properties** (button) ④ (*Figure 1 - 29 on page 1 - 39*).

OR

3. Right-click the desktop and select **Graphics Properties** from the menu.

OR

4. Click the icon  in the notification area of the Desktop taskbar and select **Graphics Properties** from the menu.

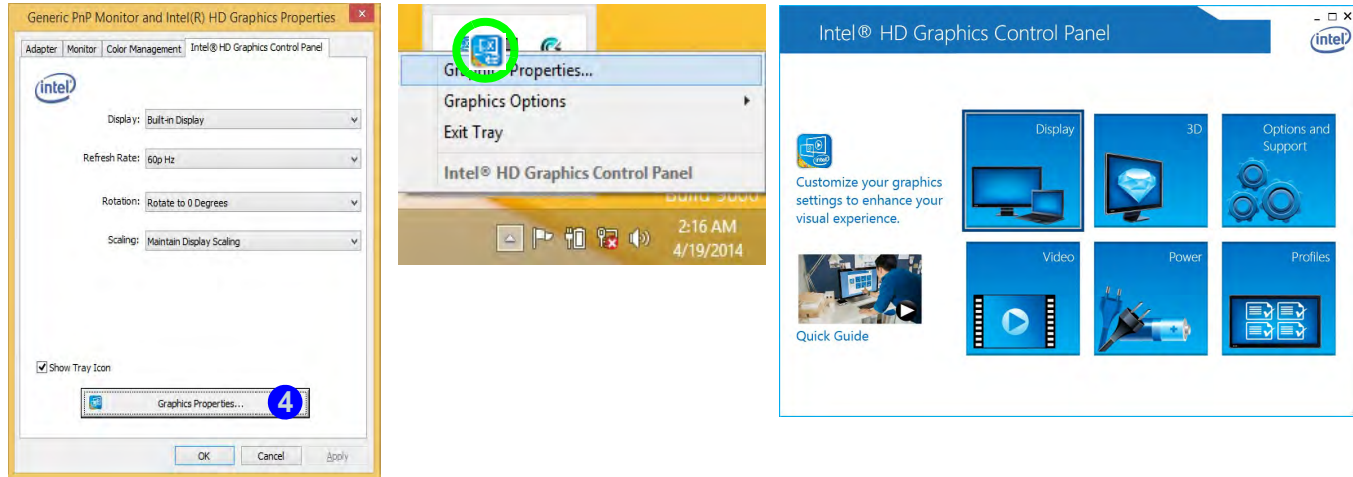
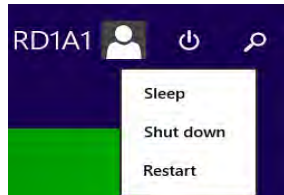

Figure 1 - 29 - Intel Graphics Control Panel

Power Options

Power Options (Hardware and Sound) can be accessed from the Control Panel. The **Power Menu** item in **Settings** in the **Charms Bar** in *Windows 8.1* may be used to **Shut down** or **Restart** (you can also add **Hibernate/Sleep** to the menu - see *“Adding Hibernate/Sleep to the Power Menu” on page 3 - 10*). You can also use the context menu (**Shut down or sign out**) shut the computer down/restart etc.

Power Button Start Screen



Charms Bar



Desktop App

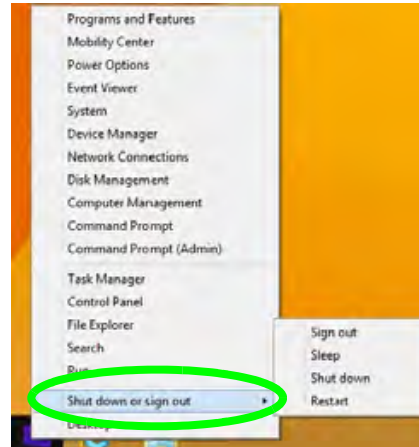

Start Screen

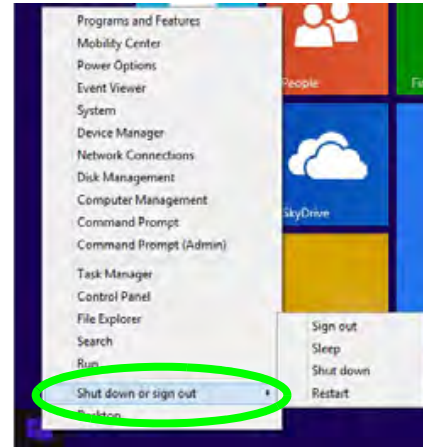

Figure 1 - 30 - Shut Down/Restart

Running Apps

To run apps in *Windows 8.1* you will need to check that the **Screen Resolution** and **User Account Control Settings** are compatible with the system requirements.

Screen Resolution Settings

1. Switch to the Windows Desktop (click the app or use the Windows logo key **+** **D** key combination).
2. Right-click a blank area of the Windows Desktop and select **Screen Resolution**. Adjust the **Resolution** to make sure that it is at least **1024 * 768**, although preferably **1366 * 768** or above (see sidebar).

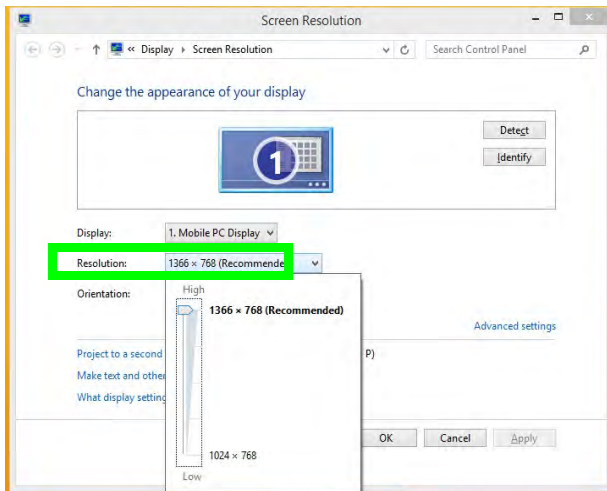

Figure 1 - 31 - Screen Resolution Settings



Screen Resolution for Apps (Windows 8.1)

The minimum resolution in which Apps will run is **1024x768**.

The minimum resolution required to support all the features of Windows 8 (including multitasking with snap) is **1366x768**.

These specs are the minimum screen resolution that supports all the features of Windows 8.1 on a useful physical size.

Quick Start Guide

User Account Control Settings

If your computer meets the minimum screen resolution requirements, and still you can't run apps, then that you have to check the status of **User Account Control (UAC)**. Apps may fail to open when the UAC is turned off. To check whether the UAC is on or off, follow the instructions below.

1. Open the **Control Panel**.
2. Click on **User Accounts** and then click on **Change User Account Control settings** (or click **System and Security** and click **Change User Account Control Settings** under **Action Center**).
3. If the slider is in the **Never notify** position, then the UAC is disabled.
4. To enable or turn on the UAC, move the slider to **Always notify** or **Notify me when apps try to make changes to my computer (default)** position, and then click **OK**.

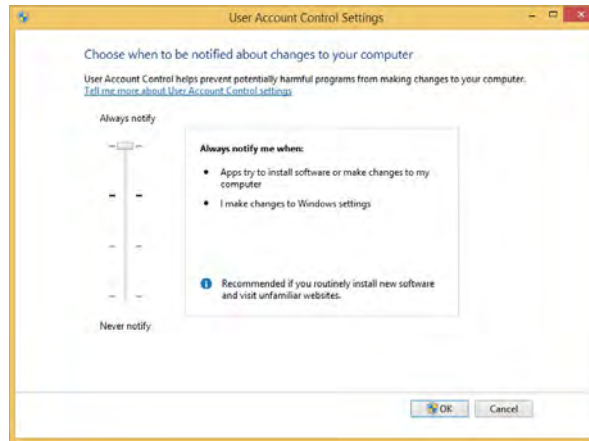

Figure 1 - 32 - User Account Control

Chapter 2: Features & Components

Overview

Read this chapter to learn more about the following main features and components of the computer:

- Hard Disk Drive/Solid State Drive
- Optical (CD/DVD) Device
- Multi-In-1 Card Reader
- Touchpad and Buttons/Mouse
- Audio Features



Bottom Cover Removal Warning

Do not remove any cover(s) and /or screw(s) for the purposes of device upgrade as this may violate the terms of your warranty.

If you need to replace/remove the hard disk for any reason, please contact your distributor/supplier for further information.

Hard Disk Drive/Solid State Drive

The hard disk drive/solid state drive is used to store your data in the computer. The hard disk can be taken out to accommodate other serial (SATA) hard disk drives, however you will need to contact your distributor/supplier to do this in order to avoid violating the terms of your warranty. The system can also support solid state drives as storage devices (see *“Storage” on page D - 2* for specification information).



Caddy Bay Devices

Model B & C computers support a caddy bay for the installation of a storage device. e.g. HDD. Note that the device installed in the caddy bay is to be used for data storage only, and will not support the installation of an OS (Operating System).

Optical (CD/DVD) Device

There is a bay for a 5.25" optical (CD/DVD) device (12.7mm height). The actual device will depend on the module you purchased (see *“Storage” on page D - 2*). The optical device is usually labeled **“Drive D:”** and may be used as a boot device if properly set in the **BIOS** (see *“Boot Menu” on page 5 - 14*).

Loading Discs

To insert a CD/DVD, press the open button ❶ and carefully place a CD/DVD onto the disc tray with label-side facing up (use just enough force for the disc to click onto the tray’s spindle). Gently push the CD/DVD tray in until its lock “clicks” and you are ready to start. The busy indicator ❷ will light up while data is being accessed, or while an audio/video CD, or DVD, is playing. If power is unexpectedly interrupted, insert an object such as a straightened paper clip into the emergency eject hole ❸ to open the tray.



Sound Volume Adjustment

How high the sound volume can be set depends on the setting of the volume control within **Windows**. Click the **Volume** icon on the notification area to check the setting (see *“Audio Features” on page 2 - 24*).

Figure 2 - 1
Optical Device



CD Emergency Eject

If you need to manually eject a CD (e.g. due to an unexpected power interruption) you may push the end of a straightened paper clip into the emergency eject hole. However please do NOT use a sharpened pencil or similar object that may break and become lodged in the hole.

Disk Eject Warning

Don't try to remove a CD/DVD while the system is accessing it. This may cause the system to "crash".

Handling CDs or DVDs

Proper handling of your CDs/DVDs will prevent them from being damaged. Please follow the advice below to make sure that the data stored on your CDs/DVDs can be accessed.

Note the following:

- Hold the CD or DVD by the edges; do not touch the surface of the disc.
- Use a clean, soft, dry cloth to remove dust or fingerprints.
- Do not write on the surface with a pen.
- Do not attach paper or other materials to the surface of the disc.
- Do not store or place the CD or DVD in high-temperature areas.
- Do not use benzene, thinner, or other cleaners to clean the CD or DVD.
- Do not bend the CD or DVD.
- Do not drop or subject the CD or DVD to shock.

DVD Regional Codes

To change the DVD regional codes:

1. Go to the **Control Panel**
2. Double-click **Device Manager (Hardware and Sound > Devices and Printers)**, then click the arrow next to **DVD/CD-ROM drives**.
3. Double-click on the DVD-ROM device to bring up the **Properties** dialog box, and select the **DVD Region** (tab) to bring up the control panel to allow you to adjust the regional code.
4. DVD region detection is device dependent, not OS-dependent. You can select your module's region code **5** times. The fifth selection is permanent. This cannot be altered even if you change your operating system or you use the module in another computer.

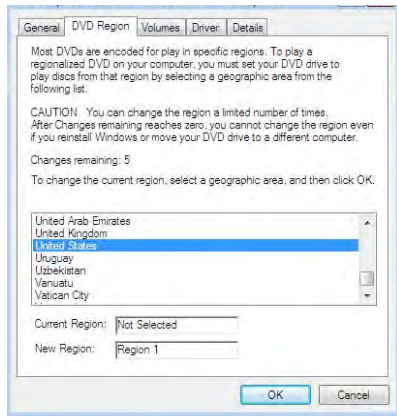

- **Region 1** - USA & Canada
- **Region 2** - Western Europe, Japan, South Africa, Middle East & Egypt
- **Region 3** - South-East Asia, Taiwan, South Korea, The Philippines, Indonesia, Hong Kong
- **Region 4** - South & Central America, Mexico, Australia, New Zealand
- **Region 5** - N Korea, Russia, Eastern Europe, India & Most of Africa
- **Region 6** - China

Figure 2 - 2
DVD Region Codes



Push-Push Card Reader (Model C Computers)

The card reader in **Model C** computers features a push-in/push-out card insertion and ejection mechanism. Simply push the card to insert and eject it.

Multi-In-1 Card Reader

The card reader allows you to use some of the latest digital storage cards. Push the card into the slot and it will appear as a removable device, and can be accessed in the same way as your hard disk (s). Make sure you install the card reader driver (see *“CardReader” on page 4 - 6*).

For All Models:

- MMC (MultiMedia Card) / RSMMC
- SD (Secure Digital) / Mini SD / SDHC / SDXC

For Models A & B Only:

- MS (Memory Stick) / MS Pro / MS Duo

***Note:** The PC adapters are usually supplied with these cards.

Figure 2 - 3
Front View
(Models A & B)
Front View
(Model C)

1. Card Reader

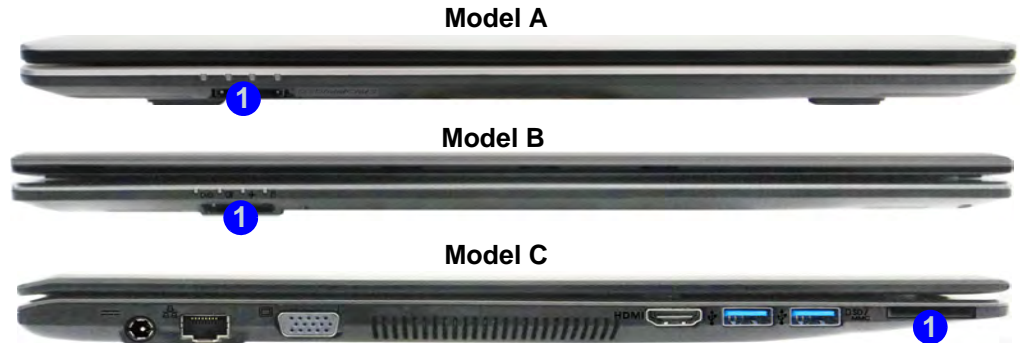

Touchpad and Buttons/Mouse

The Touchpad is an alternative to the mouse; however, you can also add a mouse to your computer through one of the USB ports. The Touchpad buttons function in much the same way as a two-button mouse.

There are two TouchPad drivers available for this computer model series. The following pages contain information on both drivers.

- See pages [2 - 9](#) to [2 - 14](#) for Touchpad information for **Models A & B**.
- See pages [2 - 15](#) to [2 - 23](#) for Touchpad information for **Model C**.



Touchpad Scrolling

This computer model series may feature different Touchpad versions.

These Touchpads may differ in their vertical scrolling function in most scrollable windows.

Some Touchpads require sliding the finger up and down on the right of the Touchpad to scroll the window. Other versions require tapping/holding down the finger at the top right or bottom right of the Touchpad to scroll the window.

Touchpad Sensitivity

The **mouse button zones** at the bottom of the pad are defined by the line at the **bottom** of the pad, and the **left and right buttons** are divided roughly down the middle as illustrated below. The active area of the touchpad is that defined in the diagram below. Press the left button zone for a left click, and right button zone for a right click action.

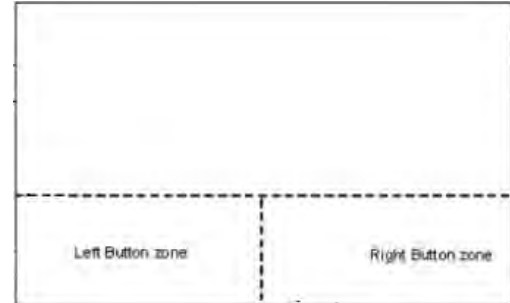
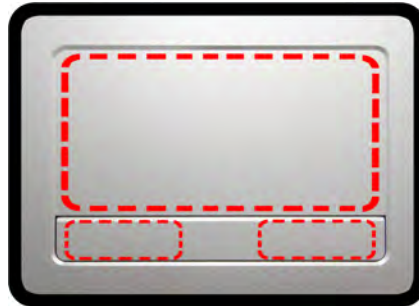

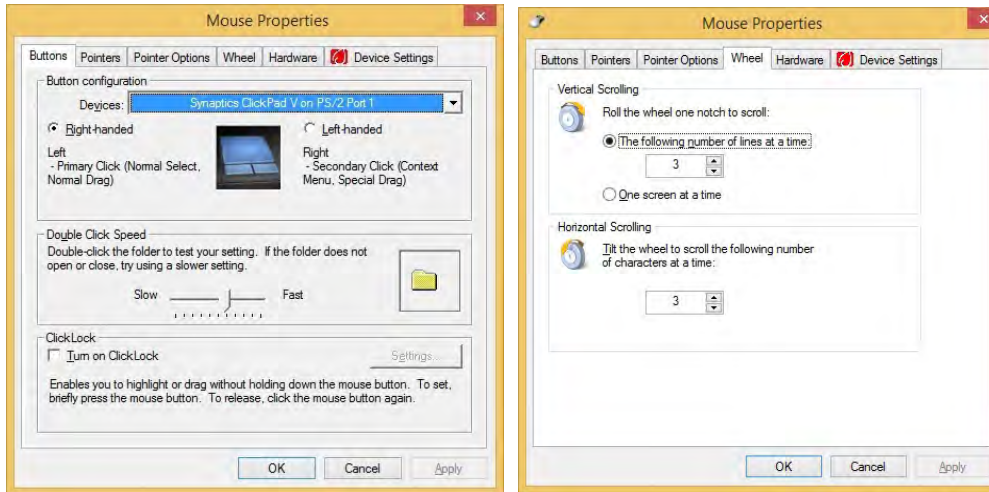

Figure 2 - 4
Touchpad Sensitivity

Synaptics TouchPad Configuration (for Models A & B)

Once you have installed the Touchpad driver (see *“Touchpad” on page 4 - 6*) you can configure the functions by double-clicking the Touchpad driver icon  in the notification area of the taskbar. You may then configure the Touchpad tapping, buttons, scrolling (see sidebar), pointer motion and sensitivity options to your preferences.



Touchpad Scrolling

This computer model series may feature different Touchpad versions.

These Touchpads may differ in their vertical scrolling function in most scrollable windows.

Some Touchpads require sliding the finger up and down on the right of the Touchpad to scroll the window. Other versions require tapping/holding down the finger at the top right or bottom right of the Touchpad to scroll the window.

Figure 2 - 6
Mouse Properties



Show Video

You can get a clearer view of the gestures involved by clicking the **Show Video** option for each gesture item.

Select the gesture (**Pinch Zoom, Rotating, Three Fingers Down and Three Finger Flick**) in the **Device Settings > Settings** left tree menu and click the **Show Video** button to see the demonstration video.

For more details on any of the gestures see the **help** in the lower part of the right menu window.

Gestures and Device Settings

The Synaptics Gestures Suite application allows you to use a specific gesture (action) on the surface of the Touchpad to perform specific actions to manipulate documents, objects and applications.

You can configure the settings from the Device Settings tab in **Mouse Properties**:

1. Click **Start**, and click **Control Panel** (or point to **Settings** and click **Control Panel**).
2. Click **Mouse (Hardware and Sound)**.
3. Click **Device Settings** (tab) and click **Settings**.
4. Use the menu tree on the left to access the user configurable settings.

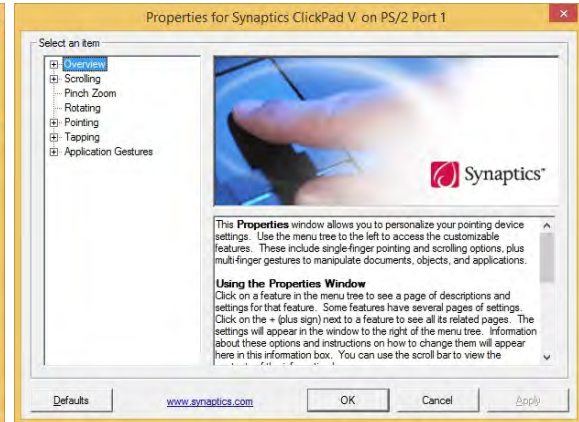
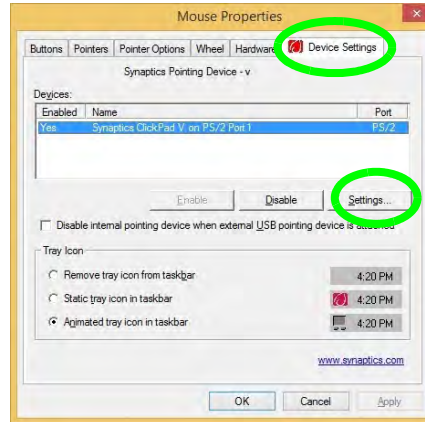

Figure 2 - 7
Mouse Properties - Device Settings

Disabling the Touchpad

If you need to disable the Touchpad for any reason (e.g. you may find that when using the computer's internal keyboard you accidentally trigger the Touchpad when resting your wrists or palms on it) you can do so by using **Fn + F1** key combination.

You can also set the system to automatically disable the internal Touchpad when an external USB point device (e.g a USB mouse) is attached.

1. Go to the **Mouse Properties** control panel.
2. Click to select **Device Settings** (tab).
3. Click to place a check in the "**Disable internal pointing device when external USB pointing device is attached**" check box.
4. Click **OK** to save the setting.

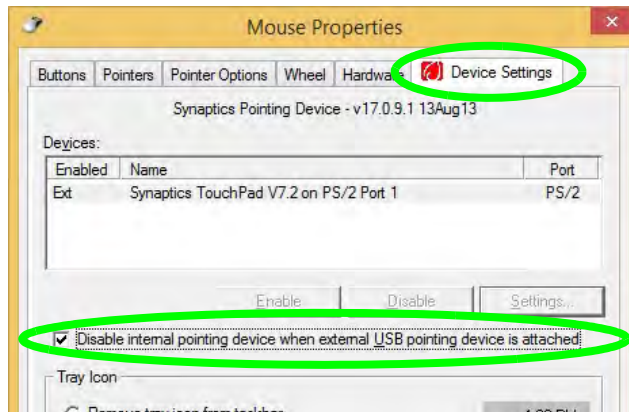

Figure 2 - 8
Mouse Properties
(Disable Touchpad)



PalmCheck™

In order to improve Clickpad/Touchpad scrolling responsiveness when using one-finger scrolling, you can adjust the PalmCheck™ slider towards “Minimum” as per your preference.

However bear in mind that adjusting the slider too far towards “Minimum” can turn off Palm-Check™ altogether.

Figure 2 - 9
PalmCheck™ Slider

PalmCheck™

The PalmCheck™ feature (**Device Settings > Settings > Pointing > Sensitivity**) helps prevent operating the Clickpad/Touchpad by accident, by recognizing when your palm is resting on it or brushing its surface while you are typing.

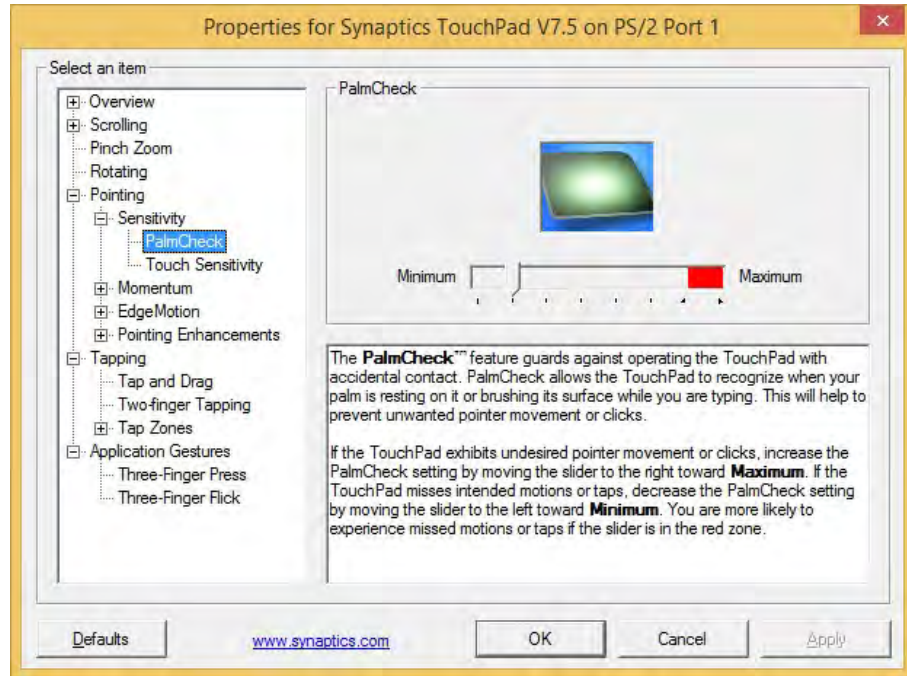

Scrolling

The Two-Finger scrolling feature works in most scrollable windows and allows you to scroll horizontally and vertically. Place two fingers, slightly separated, on the Touchpad surface and slide both fingers in the direction required (in a straight continuous motion).



Figure 2 - 10
Scrolling Gesture

Zooming

The Pinch Zoom gesture can be used to perform the same function as a scroll wheel in *Windows* applications that support CTRL + scroll wheel zoom functionality. Place two fingers on the Touchpad (for best results use the tips of the fingers) and slide them apart to zoom in, or closer together to zoom out.



Mouse Driver

If you are using an external mouse your operating system may be able to auto-configure your mouse during its installation or only enable its basic functions. Be sure to check the device's user documentation for details.

Figure 2 - 11
Zooming Gesture

Rotating

Use the Pivot Rotate gesture to rotate objects (e.g. photos) in 90 degree increments. Place a finger down on the left “target” zone and keep it stationary. Place another finger near the middle of the Touchpad and slide it in a circular motion around the stationary finger (clockwise or counterclockwise) to rotate the object.

Figure 2 - 12
Rotating Gesture



Three Finger-Flick/Three Fingers Down (Press)

The Three Finger-Flick gesture may be used to enhance navigation with a variety of applications such as browsing the Internet or scrolling through a photo viewer. The Three Fingers Down gesture may be used to launch user-selectable applications.

Figure 2 - 13
Flick/Press Gesture



Elan TouchPad Configuration (for Model C)

Once you have installed the touchpad driver (see *“Touchpad” on page 4 - 6*) you can configure the functions by double-clicking the touchpad driver icon  in the notification area of the **taskbar** (or from **Options** in the **ELAN** tab in the **Mouse** control panel in *Windows*). You may then configure the gestures and options to your preferences.

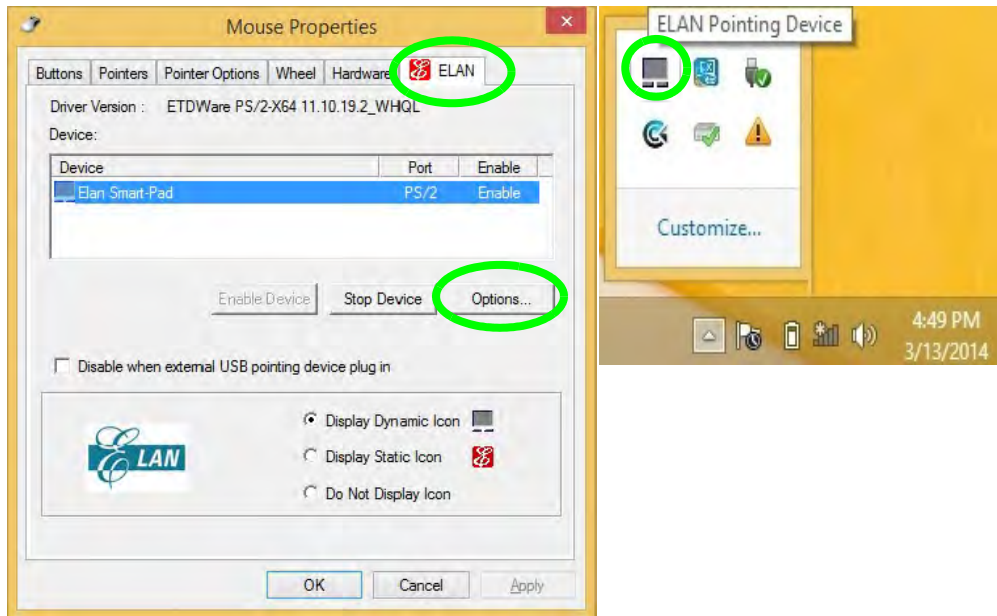



Figure 2 - 14
Mouse Properties (ELAN tab) & Taskbar Icon

Mouse Driver

If you are using an external mouse your operating system may be able to auto-configure your mouse during its installation or only enable its basic functions. Be sure to check the device's user documentation for details.

The **Elan Smart-Pad** control panel allows you to use a specific gesture (action) on the surface of the touchpad to perform specific actions to manipulate documents, objects and applications.

Click the menu tabs (**One-finger**, **Multi-finger** or **Additional**) and then the function button on the left to access the **Configuration** controls in the right panel. Click the check box to **Enable** most of the controls and click **Apply** to save the settings. Click the close icon  or **Yes** to close the control panel.

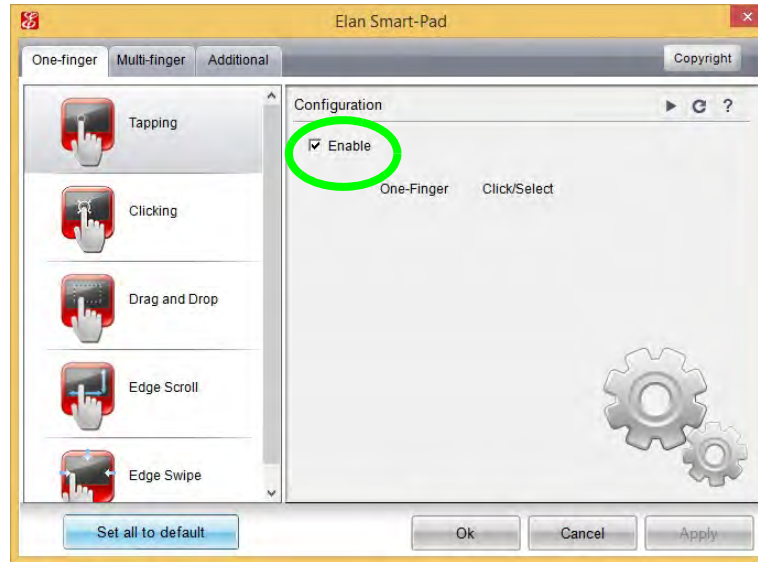



Figure 2 - 15
Smart-Pad Control Panel (Button)

Click the **Function Description**  button to get a detailed description of any function.

Click the **Default**  button to set any of the functions to the default setting.



Figure 2 - 16
**Smart-Pad Control
Panel with
Function
Description**

One-Finger

Tapping

One-Finger tapping is equivalent to clicking the left mouse button to perform a point/click/select function.

Figure 2 - 17
Tapping



Clicking

You can configure actions for **two-finger**, **three-finger** and left or right corner clicking actions from the clicking menu.

Figure 2 - 18
Clicking



Drag and Drop

You can select the different drag and drop methods from the menu provided. The object can be released when you lift the finger off the touchpad, when you tap again or after a set time delay.



Figure 2 - 19
Drag and Drop

Edge Scroll

Enable Vertical or Horizontal Scroll from this menu. You can configure the width of the scrollable area by adjusting the slider accordingly. To scroll vertically, tap the right edge of the touchpad and drag the finger up and down. To scroll horizontally, tap the bottom edge of the touchpad and drag your finger left or right.



Figure 2 - 20
Edge Scroll

Edge Swipe

Enable Edge Swipe to use a single finger to scroll from the edges of the touchpad to perform the designated function in *Windows 8*.

Figure 2 - 21
Edge Swipe



Multi-Finger

Zooming

Place two fingers on the touchpad (for best results use the tips of the fingers) and slide them apart to zoom in, or closer together to zoom out.



Figure 2 - 22
Zooming

Scrolling

The Two-Finger scrolling feature works in most scrollable windows and allows you to scroll horizontally and vertically. Tap the pad surface and slide both fingers in the direction required (vertically or horizontally as long as the option is selected).



Figure 2 - 23
Scrolling

Note that the scrolling direction is opposite to that of a standard mouse wheel configuration.

Rotation

You can rotate objects by using a two-finger gesture. Touch and rotate using two fingers on the pad in the direction required. Alternatively place a finger down on the pad and rotate the other finger around it in a circular motion (clockwise or counter-clockwise).

Figure 2 - 24
Rotation



Three Finger Swipe

This gesture is used to activate a Page Up/Page Down operation. Swipe three fingers quickly to the left to go to the previous page, or to the right to go to the next page. After you release your fingers from the pad the page changes, and make sure to lift your fingers immediately after the page change.

Figure 2 - 25
Swipe Page



Additional

Palm Tracking

This feature helps guard against accidental contact such as palms resting on the pad. Use the slider to adjust the sensitivity of the feature as appropriate.



Figure 2 - 26
Palm Tracking

Sensitivity

Adjust the level of finger pressure required for the cursor to respond from this menu.



Figure 2 - 27
Sensitivity

Sound Volume Adjustment

The sound volume level is set using the volume control on the **Windows** desktop (and the **volume function keys F5/F6** on the computer). Click the volume icon in the taskbar to check the setting.

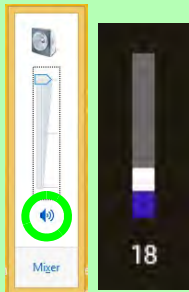

Figure 2 - 28
VIA HD Audio Deck

Audio Features

You can configure the audio options on your computer from the **Sound** control panel in **Windows**, or from the **Realtek HD Audio Manager** icon in the taskbar notification area/control panel (right-click the taskbar notification area icon to bring up an audio menu). The volume may also be adjusted by means of the **volume icon in the taskbar or the audio slider in the Settings menu** (see sidebar).



Right-click the icon to access the menu above.

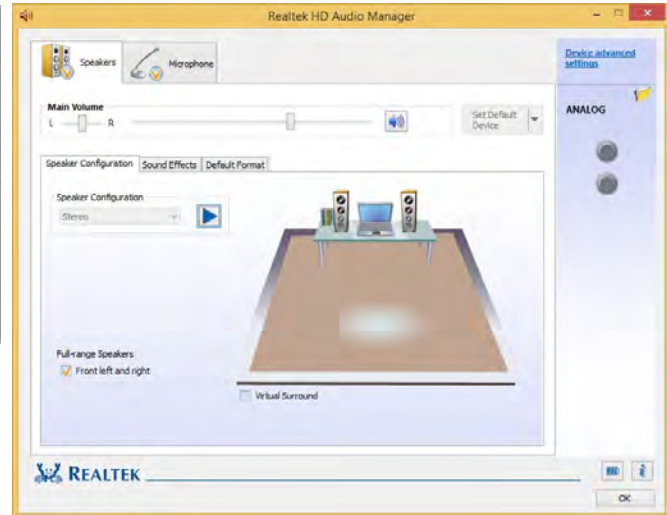

Setup for Audio Recording

To record audio sources on your computer at optimum quality follow the instructions below:

1. Go to the **Control Panel**.
2. Click **Realtek HD Audio Manager (Hardware and Sound)**, or right-click the taskbar icon  and select **Sound Manager**.
3. Click **Microphone Effects** (tab) in **Microphone** (tab), and then click to select **Noise Suppression** (button), or adjust the **Recording Volume** level to around **60**, to obtain the optimum recording quality.
4. Click **OK** to close the control panel and save the settings.

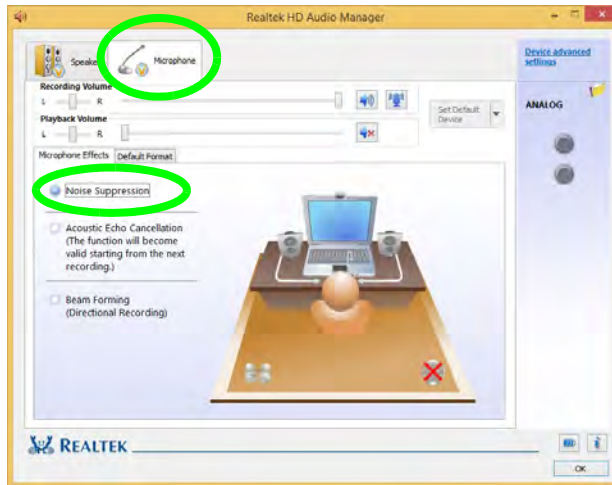

Disabling Front Jack Detection

It is recommended that **you do not disable front panel jack detection** in Connector Settings .

Disabling front panel jack detection may cause your internal microphone to become disabled, and audio may continue to play through the system's internal speakers even when headphones are plugged-in to the headphone jack (see page 7 - 9).

Figure 2 - 29
Realtek Audio Manager - Recording Setup

Chapter 3: Power Management

Overview

To conserve power, especially when using the battery, your computer power management conserves power by controlling individual components of the computer (the monitor and hard disk drive) or the whole system. This chapter covers:

- The Power Sources
- Turning On the Computer
- Power Plans
- Power-Saving States
- Configuring the Power Buttons
- Battery Information
- Intel® Dynamic Platform & Thermal Framework
- Removing the Battery for Model B Computers
- Removing the Battery for Model C Computers

The computer uses enhanced power saving techniques to give the operating system (OS) direct control over the power and thermal states of devices and processors. For example, this enables the OS to set devices into low-power states based on user settings and information from applications.



OS Note

Power management functions will vary slightly depending on your operating system. For more information it is best to refer to the user's manual of your operating system.



Forced Off

If the system “hangs”, and the **Ctrl + Alt + Del** key combination doesn’t work, press the power button for **4 seconds**, or longer, to force the system to turn itself off.

The Power Sources

The computer can be powered by either an AC/DC adapter or a battery pack.

AC/DC Adapter

Use only the AC/DC adapter that comes with your computer. The wrong type of AC/DC adapter will damage the computer and its components.

1. Attach the AC/DC adapter to the DC-in jack on the left of the computer.
2. Plug the AC power cord into an outlet, and connect the AC power cord to the AC/DC adapter (**make sure you use the adapter when first setting up the computer**, as to safeguard the computer during shipping the battery will be locked to not power the system until first connected to the AC/DC adapter).
3. Raise the lid/LCD to a comfortable viewing angle.
4. Press the power button to turn “On”.

Battery

The battery allows you to use your computer while you are on the road or when an electrical outlet is unavailable. Battery life varies depending on the applications and the configuration you're using. **To increase battery life, let the battery discharge completely before recharging** (see *“Battery FAQ” on page 3 - 18*).

We recommend that you do not remove the battery. For more information on the battery, please refer to *“Battery Information” on page 3 - 14*.

Turning On the Computer

Now you are ready to begin using your computer. To turn it on simply press the power button on the front panel.

When the computer is on, you can use the power button as a Stand by/Hibernate/Shutdown hot-key button when it is pressed for less than **4 seconds** (pressing and holding the power button for longer than this will shut the computer down). Use **Power Options (Hardware and Sound)** in the *Windows* control panel to configure this feature.



Power Button as Stand by or Hibernate Button

You can use the OS's "Power Options" control panel to set the power button to send the system into Stand by or Hibernate mode (see your OS's documentation, or "[Configuring the Power Buttons](#)" on page 3 - 9 for details).

Shutting the Computer Down

Note that you should always shut your computer down by choosing the **Shut down** command as this will help prevent hard disk or system problems. Use the **Shut down or sign out** item in the **Context Menu** (right-click the lower left corner of the screen to bring up the menu).

You can also use the **Power Menu** in **Settings** in the **Windows Charms Bar**. If you want to add Hibernate/Sleep to the Power Menu see *“Adding Hibernate/Sleep to the Power Menu” on page 3 - 10*.

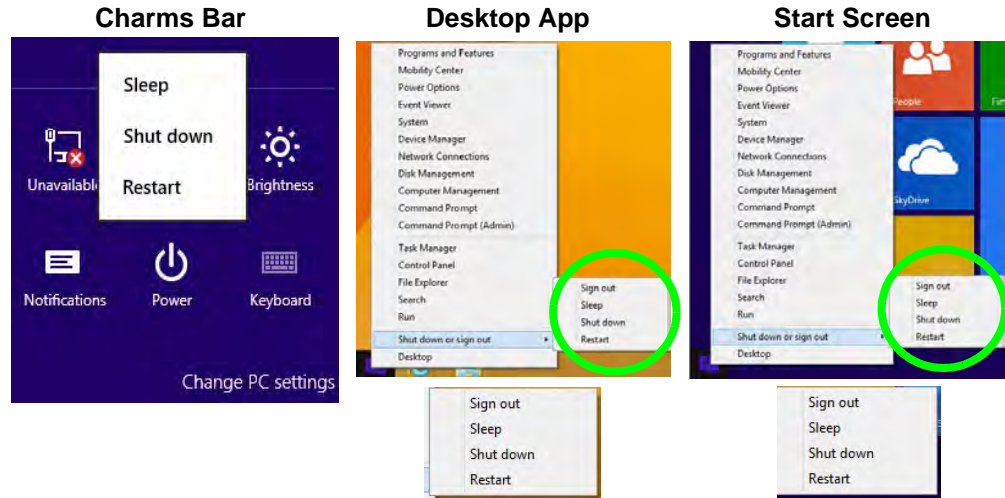

Figure 3 - 1
Shut Down/Restart

Power Plans

The computer can be configured to conserve power by means of **power plans**. You can use (or modify) an existing **power plan**, or create a new one.

The settings may be adjusted to set the **display** to turn off after a specified time, and to send the computer into **Sleep** after a period of inactivity.

Click *Change plan settings* and then click *Change advanced power settings* to access further configuration options in **Advanced Settings**.

See *“Intel® Dynamic Platform & Thermal Framework” on page 3 - 22* for further advanced power plan settings.

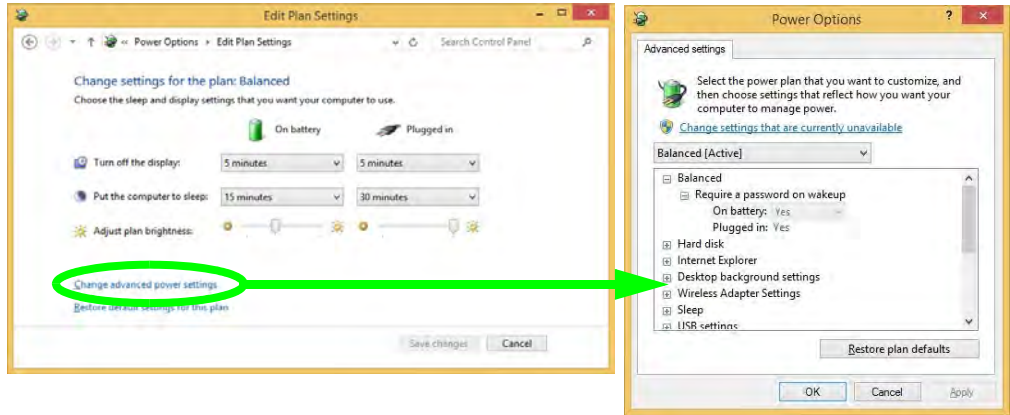

Resuming Operation

See *Table 3 - 1, on page 3 - 11* for information on how to resume from a power-saving state.

Password

It is recommended that you enable a password on system resume in order to protect your data.

Figure 3 - 2
Power Plan
Advanced Settings

Power Management

3

Each **Windows power plan** will also adjust the processor performance of your machine in order to save power. This is worth bearing in mind if you are experiencing any reduced performance (especially under DC/battery power).

Choose **High performance** (you may need to click **Show additional plans** to view the High performance plan) for maximum performance when the computer is powered from an AC power source. Choose the **Power saver** (bear in mind that this scheme may slow down the overall performance of the computer in order to save power) for maximum power saving when the computer is battery (DC power) powered.

Figure 3 - 3
Power Plans

Click to Show/Hide additional power plans

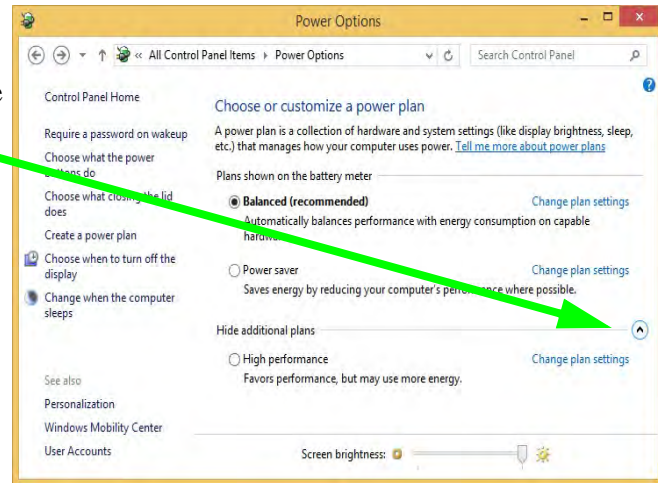

Power-Saving States

You can use power-saving states to stop the computer’s operation and restart where you left off. *Windows* uses the **Sleep**, **Hibernate** and **Shut Down** power-saving states.

Sleep

In **Sleep** all of your work, settings and preferences are saved to memory before the system sleeps. When you are not using your computer for a certain length of time, which you specify in the operating system, it will enter **Sleep** to save power.

The PC wakes from **Sleep within seconds** and will return you to where you last left off (what was on your desktop) without reopening the application(s) and file(s) you last used.

If your mobile PC in **Sleep** is running on battery power the system will use only a minimum amount of power. After an extended period the system will save all the information to the hard disk and shut the computer down before the battery becomes depleted.

To add **Sleep** to the **Power Menu** see *“Adding Hibernate/Sleep to the Power Menu” on page 3 - 10.*



Wake On LAN Support

Wake-On-LAN is only supported from **Sleep** or **Hibernate** states in *Windows*.

If you require your computer to wake up from network activity in *Windows* then make sure that the computer is either in **Sleep** or **Hibernate**.

Wake-On-LAN is not supported from **Shut-down** states in *Windows*.

Hibernate

Hibernate uses the least amount of power of all the power-saving states and saves all of your information on a part of the hard disk before it turns the system off. If a power failure occurs the system can restore your work from the hard disk; if a power failure occurs when work is saved only to memory, then the work will be lost. **Hibernate** will also return you to where you last left off within seconds. You should put your mobile PC into **Hibernate** if you will not use the computer for a period of time, and will not have the chance to charge the battery. To add **Hibernate** to the **Power Menu** see *“Adding Hibernate/Sleep to the Power Menu” on page 3 - 10*.

Shut down

You should **Shut down** the computer if you plan to install new hardware (don't forget to remove the battery and follow all the safety instructions in **Chapter 6**), plan to be away from the computer for several days, or you do not need it to wake up and run a scheduled task. Returning to full operation from **Shut down** takes longer than from **Sleep** or **Hibernate**.

Figure 3 - 4
Power Menu

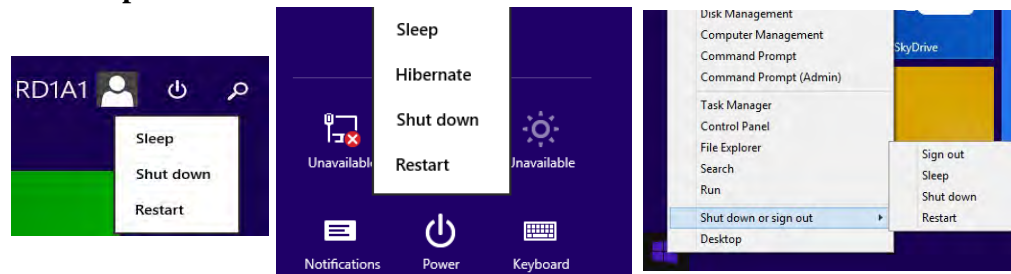

Configuring the Power Buttons

The power/sleep button (**Fn + F12** key combo) and closed lid may be set to send the computer in to a power-saving state. Click **Choose what the power buttons do** on the left menu in **Power Options** to bring up the menu.

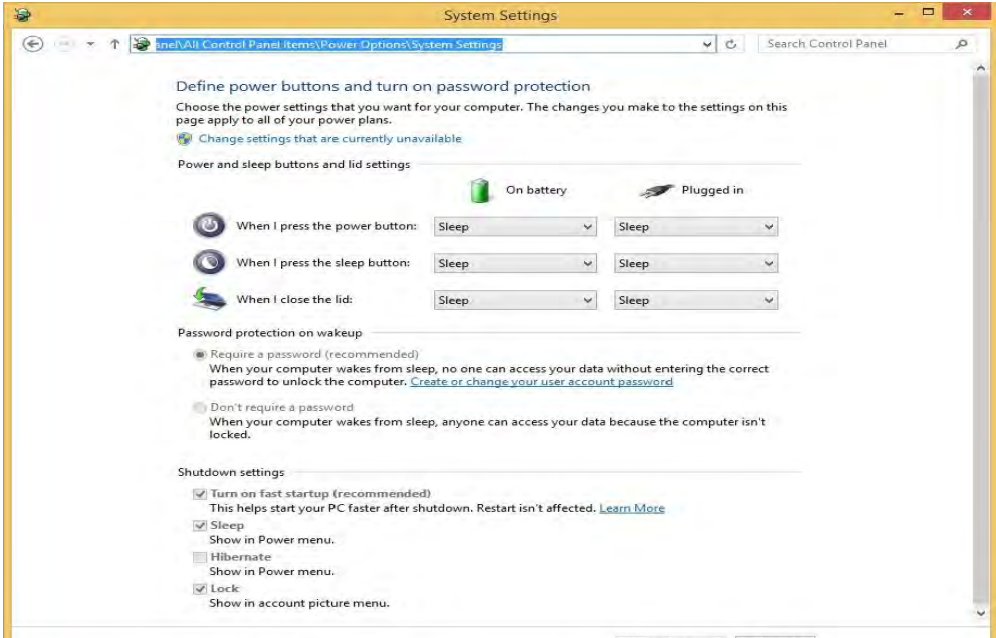



Password Protection

It is recommended that you enable a password on wake up in order to protect your data.

However you can disable this setting from the **Power Options** menu by clicking **Require a password on wakeup** in the left menu, and selecting the options (click **Change settings that are currently unavailable**).

Figure 3 - 5
Power Options
Define Power
Buttons

Adding Hibernate/Sleep to the Power Menu

Add **Hibernate/Sleep** to the **Power Menu** as follows.

1. Go to the **Power Options (Hardware and Sound)** control panel.
2. Click **“Change settings that are currently unavailable”**  [Change settings that are currently unavailable.](#)
3. Click **Choose what the power buttons do.**
4. Click to put a check in the **Hibernate/Sleep** box under **Shutdown settings.**
5. Click **Save Changes** and close the control panel.

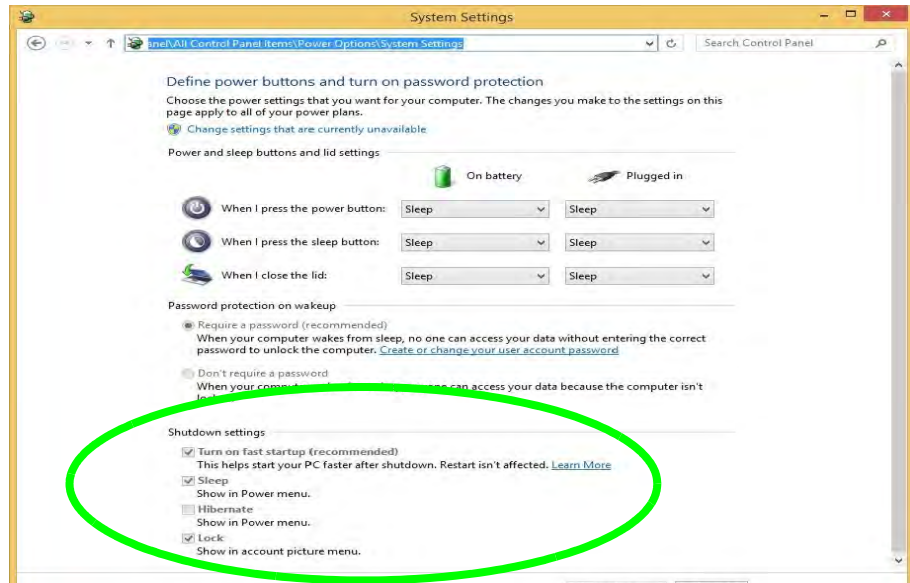

Figure 3 - 6
Power Options
Define Power
Buttons - Shutdown
Settings

Resuming Operation

You can resume operation from power-saving states by pressing the power button, or in some cases pressing the sleep button (**Fn + F12** key combo).



Power Status	Icon  Color	To Resume
Power Off	Off	Press the Power Button
Sleep	Blinking Green	Press the Power Button Press the Sleep Button (Fn + F12 Key Combo)
Hibernate	Off (battery) Orange (AC/DC adapter)	Press the Power Button
Display Turned Off	Green	Press a Key or Move the Mouse/Touchpad

Table 3 - 1
Resuming
Operation



Power Button

When the computer is on, you can use the power button as a Sleep/Hibernate/Shut Down hot key button when it is pressed for less than **4 seconds** (pressing and holding the power button for longer than this will force the computer to shut down).



Closing the Lid

If you have chosen to send the computer to **Sleep** when the lid is closed, raising the lid will wake the system up.



Power Conservation Modes

The **Energy Star** setting will result in maximum power saving, but with the possible loss of some performance.

Setting the mode to **Balance** will give power saving matched with performance.

Performance will give optimum computer performance but with less power conservation.

Note that the Energy Star setting will put the display into sleep after no more than 15 minutes of user inactivity.

Power Conservation Modes

This system supports **Energy Star** power management features that place computers (CPU, hard drive, etc.) into a low-power sleep modes after a designated period of inactivity. Adjust **Power Conservation Modes** from the **Control Center**:

1. Press the **Fn + Esc** key combination to toggle the **Control Center** on/off.
2. Click either the **Performance**, **Balanced** or **Energy Star** button.



Figure 3 - 7
Control Center

Ctrl + Alt + Delete Key Combination

You can use the **CTRL + ALT + DEL** key combination from almost any of the *Windows 8* interfaces/Apps to bring up a full-screen displaying **Lock**, **Switch User**, **Log off**, **Change a password** and **Task Manager** options. If you click the **Power** icon in the lower right corner of the screen a power management option menu appears to display **Sleep**, **Shut down**, and **Restart**.

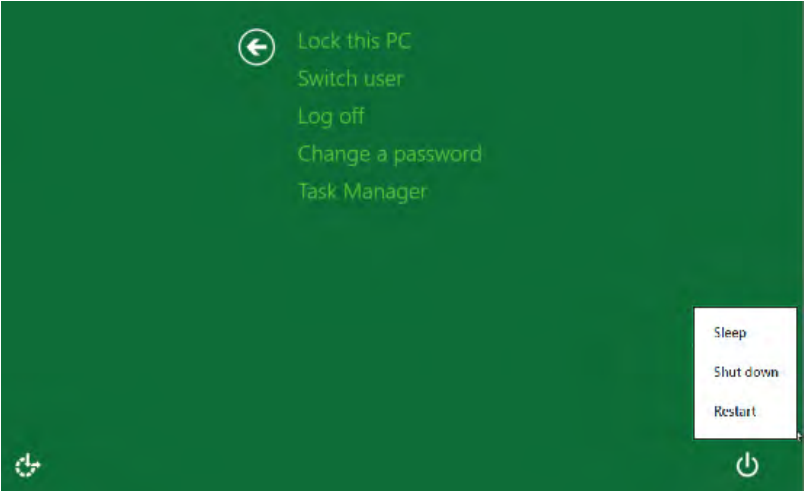

Figure 3 - 8
Ctrl + Alt + Delete
Menu

To fully control all the power options (including Hibernate mode) go to the **Power Options** control panel and configure the power button, sleep button and lid to perform the function selected.



Low Battery Warning

When the battery is critically low, immediately connect the AC/DC adapter to the computer or save your work, otherwise, the unsaved data will be lost when the power is depleted.

Battery Information

Follow these simple guidelines to get the best use out of your battery.

Battery Power

Your computer's battery power is dependent upon many factors, including the programs you are running, and peripheral devices attached. You can set actions to be taken (e.g. Shut down, Hibernate etc.), and set critical and low battery levels from power plan **Change plan settings > Change advanced power settings** (see *Figure 3 - 3 on page 3 - 6*).



Click the battery icon  in the notification area to see the current battery level and charge status.

Figure 3 - 9
Battery Icon (Notification Area) & Battery Advanced Settings

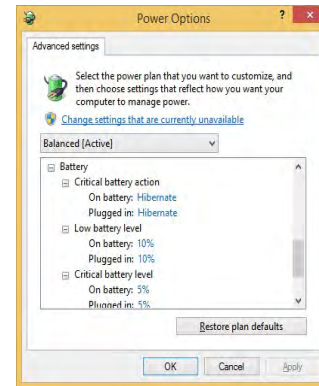

Conserving Battery Power

- Use a **power plan** that conserves power (e.g **Power saver**), however note that this may have an affect on computer performance.
- Lower the brightness level of the LCD display. The system will decrease LCD brightness slightly to save power when it is not powered by the AC/DC adapter.
- Reduce the amount of time before the display is turned off.
- Close wireless, Bluetooth, modem or communication applications when they are not being used.
- Disconnect/remove any unnecessary external devices e.g. USB devices, ExpressCards etc.

Windows Mobility Center
The **Windows Mobility Center** control panel provides an easy point of access for information on battery status, power plans used and wireless device status etc.

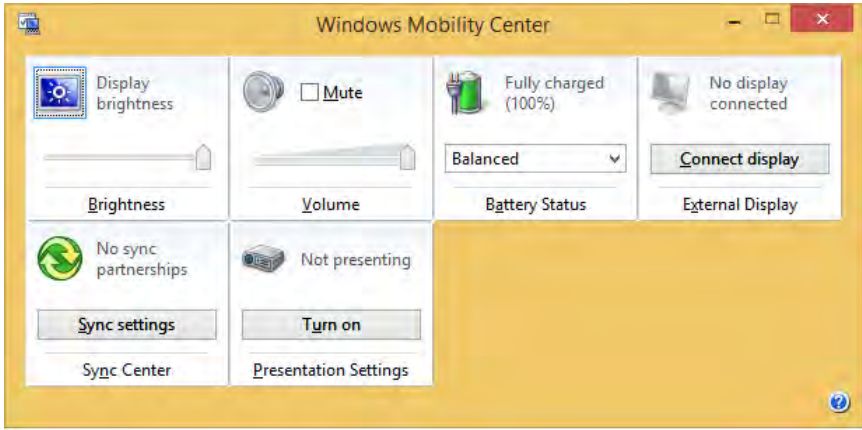

Figure 3 - 10
Windows Mobility Center



Battery Removal

We recommend that you do not remove the battery yourself. If you do need to remove the battery for any reason (e.g. long term storage) for **Model B & C** computers see page **3 - 26** or page **3 - 27**.

Removing the embedded battery from **Model A** computers may violate the terms of the warranty. Contact your distributor/supplier for details

Battery Life

Battery life may be shortened through improper maintenance. **To optimize the life and improve its performance, fully discharge and recharge the battery at least once every 30 days.** It is recommended that you use the **Battery Settings** in the **Energy Save Utility** to help maintain the life of the battery.

New Battery

Always completely discharge, then fully charge, a new battery (see *“**Battery FAQ**” on page 3 - 18* for instructions on how to do this).

Recharging the Battery with the AC/DC Adapter

The battery pack automatically recharges when the AC/DC adapter is attached and plugged into an electrical outlet. If the computer is powered on, and in use, it will take several hours to fully recharge the battery. When the computer is turned off but plugged into an electrical outlet, battery charge time is less. Refer to *“**LED Indicators**” on page 1 - 10* for information on the battery charge status, and to *“**Battery Information**” on page 3 - 14* for more information on how to maintain and properly recharge the battery pack.

Proper handling of the Battery Pack

- DO NOT disassemble the battery pack under any circumstances
- DO NOT expose the battery to fire or high temperatures, it may explode
- DO NOT connect the metal terminals (+, -) to each other



Damaged Battery Warning

Should you notice any physical defects (e.g. the battery is bent out of shape after being dropped), or any unusual smells emanating from the notebook battery, shut your computer down immediately and contact your distributor/supplier. If the battery has been dropped we do not recommend using it any further, as even if the computer continues to work with a damaged battery in place, it may cause circuit damage, which may possibly result in fire. It is recommended that you replace your computer battery every two years.



Caution

Danger of explosion if battery is incorrectly replaced.

Replace only with the same or equivalent type recommended by the manufacturer. Discard used battery according to the manufacturer's instructions.

Battery FAQ

How do I completely discharge the battery?

Use the computer with battery power until it shuts down due to a low battery. Don't turn off the computer even if a message indicates the battery is critically low, just let the computer use up all of the battery power and shut down on its own.

1. Save and close all files and applications.
2. **Create a power plan** for discharging the battery and set all the options to **Never**.

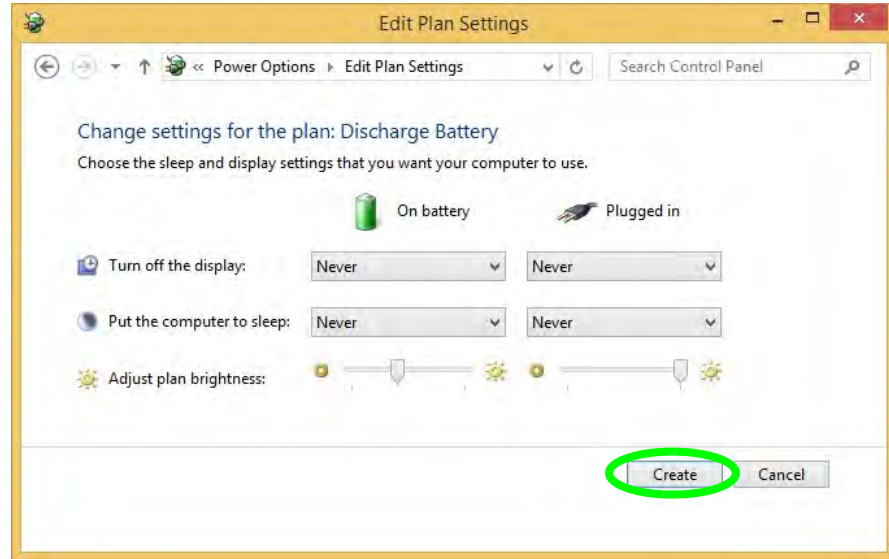

Figure 3 - 11
Power Plan Create

- 3. Click **Change plan settings** (after creating it) and click **Change plan settings > Change advanced power settings**.

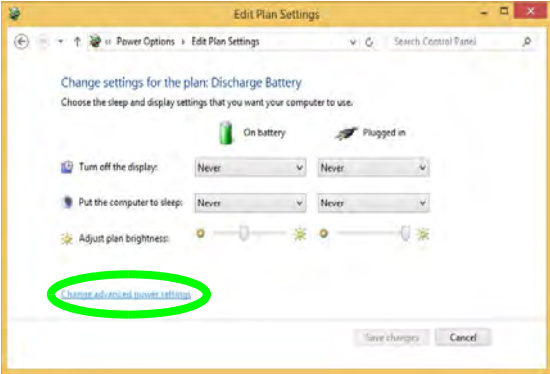
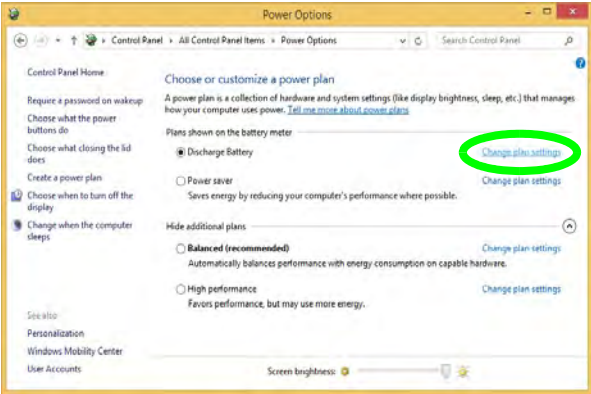
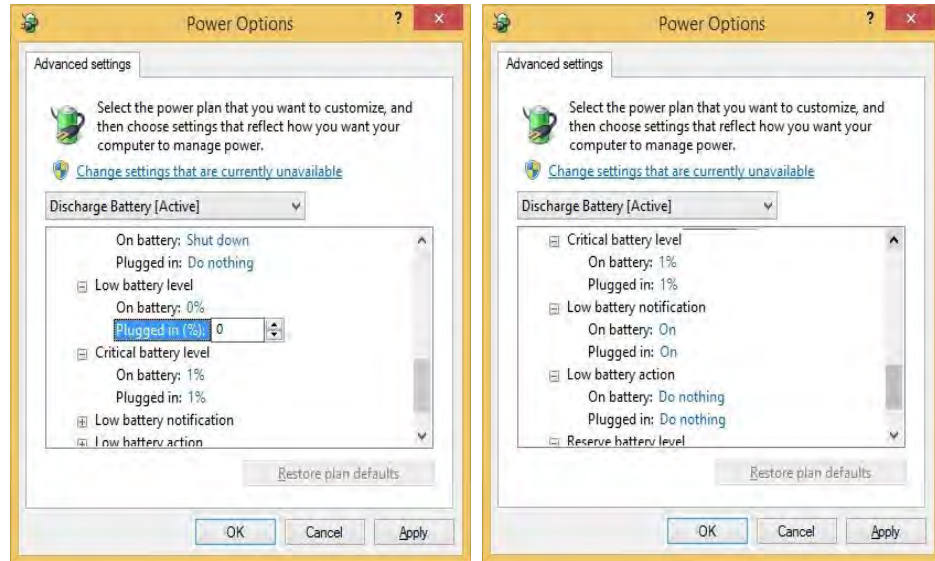

Figure 3 - 12
Change Plan
Settings / Change
Advanced Power
Settings

Power Management

4. Scroll down to **Battery** and click **+** to expand the battery options.
5. Choose the options below (click **Yes** if a warning appears):

Figure 3 - 13
Power Options
Advanced Settings -
Battery



- Low battery levels = 0%
- Critical battery Levels = 1%
- Low battery action = Do Nothing
- Critical battery action (On battery) = Shut Down
- Critical battery action (Plugged in) = Do Nothing

How do I fully charge the battery?

When charging the battery, don't stop until the LED charging indicator light changes from orange to green.

How do I maintain the battery?

Completely discharge and charge the battery at least once every 30 days or after about 20 partial discharges.

Intel® Dynamic Platform & Thermal Framework

The Intel® Dynamic Platform and Thermal Framework (**Intel® DPTF**) is a hardware/software solution for power and thermal management on your computer, and provides multiple power/thermal technologies. Simply install the driver as instructed below and the technology will provide a set of policies to effect the power management of the CPU versus the system temperature.

Intel® DPTF Driver Installation

1. **Make sure the system is not in Airplane Mode**, and then insert the *Device Drivers & Utilities + User's Manual* disc into the DVD drive.
2. Click **Install Drivers** (button).
3. Click **10.Install DPTF Driver > Yes**.
4. Click **Next**.
5. Click **Yes** to accept the license.
6. Click **Next > Finish**.
7. See over for configuration details.

Configuring Intel® Dynamic Platform & Thermal Framework

1. Go to the **Power Options (Hardware and Sound)** control panel.
2. Click **Change plan settings > Change advanced power settings** alongside one of your power plans.

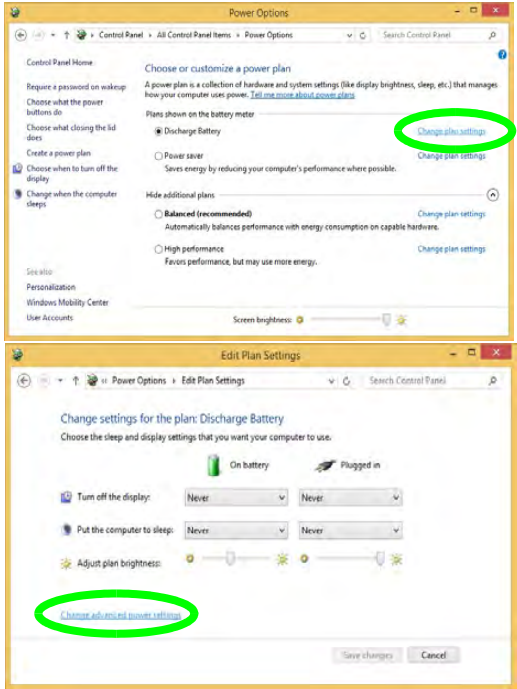

Figure 3 - 14
Change Plan
Settings / Change
Advanced Power
Settings

Power Management

3

3. Scroll down to **Intel® Dynamic Platform & Thermal Framework** and click + to expand the options.
4. Click the sub-menus to adjust the settings as required (see below and overleaf).

Figure 3 - 15
**Power Options
Advanced Settings -
Intel® Dynamic
Platform & Thermal
Framework**

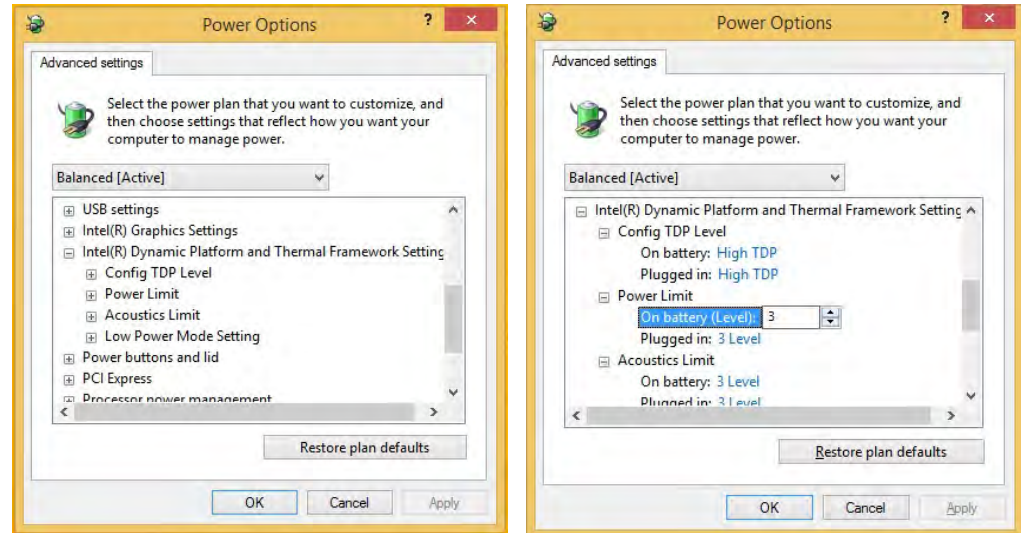

- [-] Config TDP Level
 - On battery: High TDP
 - Plugged in: High TDP
- [-] Power Limit
 - On battery (Level): 3
 - Plugged in: 3 Level

- [-] Acoustics Limit
 - On battery (Level): 3
 - Plugged in: 3 Level
- [-] Low Power Mode Setting
 - On battery: Disabled
 - Plugged in: Disabled

- **Config TDP Level** - Sets the maximum power to be used by the processor. A **High TDP** level enables high performance, but needs more cooling and thus will reduce battery life. **Nominal TDP** operates the processor at the specified TDP and clock rate. **Low TDP** reduces the power and clock rate to extend the battery life, but may reduce system performance. This can be set independently for battery use, or for when plugged-in.
- **Power Limit** - Sets the maximum power allowed for the processor. The higher values allow higher core voltage and operating clock rates, but this is at the cost of power consumption, heat and battery life.
- **Acoustics Limit** - Sets the maximum fan speed. Higher values increase the speed for maximum cooling, and the lower values limit the speed for reduced fan noise. This can be set independently for battery use, or for when plugged-in.
- **Low Power Mode Setting** - Enable this to place the processor into a special power saving mode when maximum battery life is needed.



Bottom Cover Removal Warning

Do not remove any cover(s) and /or screw(s) for the purposes of device upgrade as this may violate the terms of your warranty.

If you need to replace/remove the hard disk/RAM/optical device etc., for any reason, please contact your distributor/supplier for further information.

Figure 3 - 16
**Battery Removal for
Model B Computers**

Removing the Battery for Model B Computers

It is possible to remove the battery from **Model B** computers. We recommend that you do not remove the battery yourself. If you do need to remove the battery for any reason (e.g. long term storage) see below.

1. Turn the computer **off**, and turn it over.
2. Slide the latch **1** in the direction of the arrow.
3. Slide the latch **2** in the direction of the arrow, and hold it in place.
4. Slide the battery out in the direction of the arrow **3**.
5. Reinsert the battery as illustrated below **4**.
6. Make sure the latches are returned to the lock position **5**.

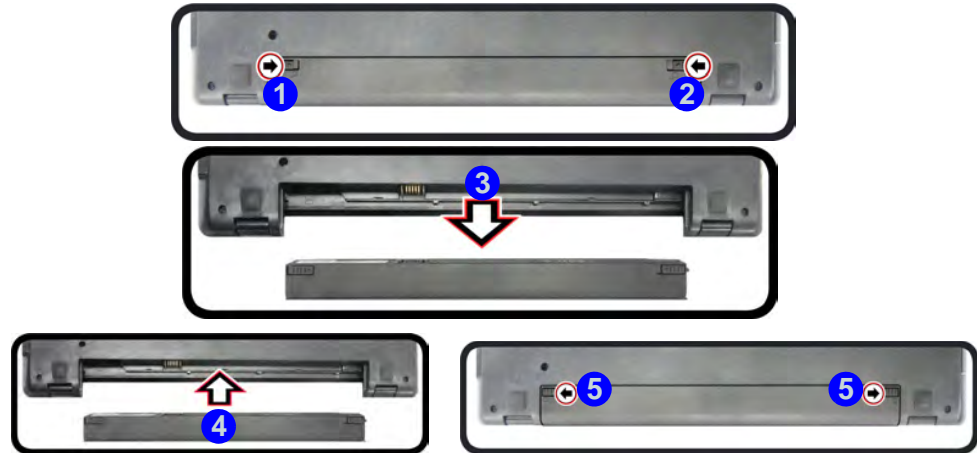

Removing the Battery for Model C Computers

It is possible to remove the battery from **Model C** computers. We recommend that you do not remove the battery yourself. If you do need to remove the battery for any reason (e.g. long term storage) see below.

1. Turn the computer **off**, and turn it over.
2. Slide the latch **1** in the direction of the arrow.
3. Slide the latch **2** in the direction of the arrow, and hold it in place.
4. Slide the battery out in the direction of the arrow **3**.
5. See over for inserting the battery instructions.

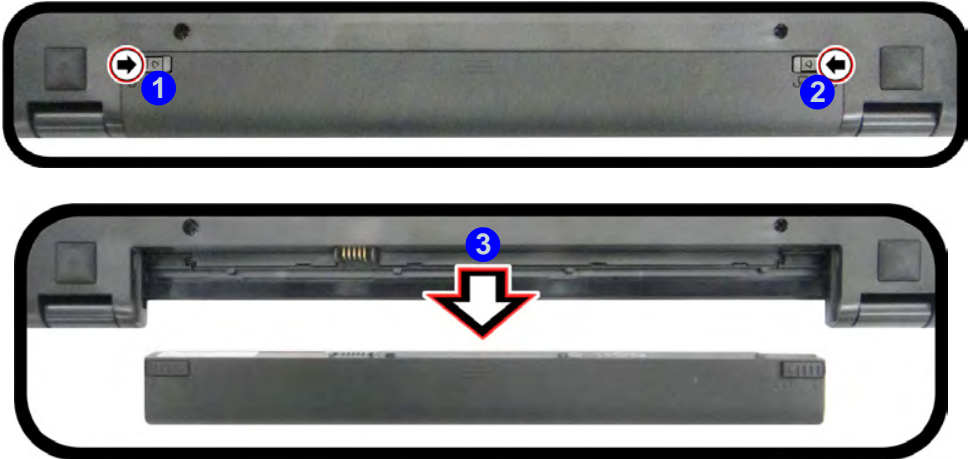

Bottom Cover Removal Warning

Do not remove any cover(s) and /or screw(s) for the purposes of device upgrade as this may violate the terms of your warranty.

If you need to replace/remove the hard disk/ RAM/optical device etc., for any reason, please contact your distributor/supplier for further information.

Figure 3 - 17
Battery Removal for Model C Computers

Chapter 4: Drivers & Utilities

This chapter deals with installing the drivers and utilities essential to the operation or improvement of some of the computer's subsystems. The system takes advantage of some newer hardware components for which the latest versions of most available operating systems haven't built in drivers and utilities. Thus, some of the system components won't be auto-configured with an appropriate driver or utility during operating system installation. Instead, you need to manually install some system-required drivers and utilities.

What to Install

The *Device Drivers & Utilities + User's Manual* disc contains the drivers and utilities necessary for the proper operation of the computer. *Table 4 - 1, on page 4 - 3* lists what you need to install and **it is very important that the drivers are installed by the method outlined in this chapter, and in the order indicated.**

Note that the information included on the following pages is for *Windows 8.1 only*. For *Windows 10* driver installation see "*Windows 10 Drivers & Utilities*" on page *E - 15*.

Module Driver Installation

The procedures for installing drivers for the **Wireless LAN** and **Combination Bluetooth & WLAN** modules are provided in "*Modules & Options*" on page *6 - 1*.



Driver Installation & Power

When installing drivers make sure your computer is powered by the AC/DC adapter connected to a working power source. Some drivers draw a significant amount of power during the installation procedure, and if the remaining battery capacity is not adequate this may cause the system to shut down and cause system problems (note that there is no safety issue involved here, and the battery will be rechargeable within 1 minute).

Driver Installation

1. Insert the *Device Drivers & Utilities + User's Manual* disc into the computer's DVD drive.
2. Click the message "**Tap to choose what happens with this disc.**"
3. Click **Run autorun.exe**.
4. Click **Install Drivers** (button), or **Option Drivers** (button) to access the **Optional** driver menu.

5. Check the driver installation order from **Table 4 - 1, on page 4 - 3** (the drivers must be installed in this order) which is the same as that listed in the *Drivers Installer* menu below.
6. Click to select the driver you wish to install, (you should note down the drivers as you install them).
7. Follow the instructions for each individual driver installation procedure as listed on the following pages.



Figure 4 - 1 - Drivers Installer Screen 1

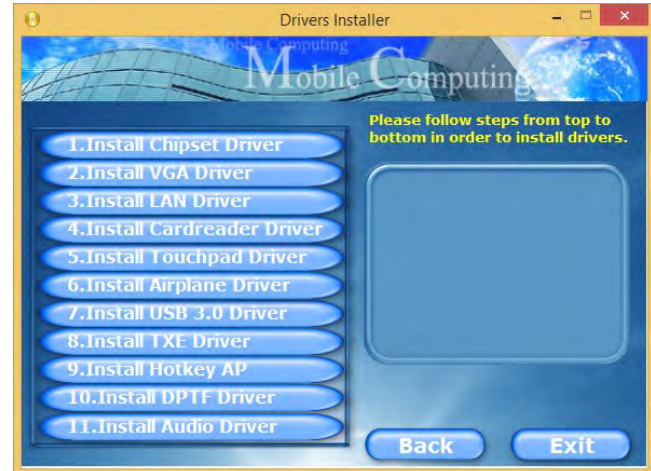

Figure 4 - 2 - Install Drivers

Win 8.1 Driver - System Required	Page #	Win 8.1 Driver (Other / Options)	Page #
Chipset	Page 4 - 6	PC Camera Module (No driver required)	Page 6 - 2
Video (VGA)	Page 4 - 6	Wireless LAN Module	Page 6 - 11
LAN	Page 4 - 6	Bluetooth & WLAN Combo Module	Page 6 - 16
CardReader	Page 4 - 6	3G/4G Module (No driver required)	Page 6 - 21
Touchpad	Page 4 - 6	Trusted Platform Module (No driver required)	Page 6 - 27
Airplane	Page 4 - 7	Wireless Display (No driver required)	Page 6 - 33
USB 3.0	Page 4 - 7		
Intel TXE	Page 4 - 7		
Hot Key	Page 4 - 7		
Intel® DPTF Driver Installation	Page 4 - 7		
Audio	Page 4 - 7		

Table 4 - 1 - Driver Installation

All drivers provided are for Windows 8.1.

Note that you need to install both the WLAN & Bluetooth drivers for the WLAN & Bluetooth Combo modules.

Manual Driver Installation

Click **Browse CD/DVD** (button) in the *Drivers Installer* application and browse to the executable file in the appropriate driver folder.

4

Windows Update

After installing all the drivers make sure you enable **Windows Update** in order to get all the latest security updates etc. (all updates will include the latest **hotfixes** from Microsoft). See [“Windows Update” on page 4 - 8](#) for instructions.

Updating/Reinstalling Individual Drivers

If you wish to update/reinstall individual drivers it may be necessary to uninstall the original driver. To do this go to the **Control Panel** in the *Windows OS* and double-click the **Programs and Features** icon (**Programs > Uninstall a program**). Click to select the driver (if it is not listed see below) and click **Uninstall**, and then follow the on screen prompts (it may be necessary to restart the computer). Reinstall the driver as outlined in this chapter.

If the driver is not listed in the **Programs and Features** menu:

1. Go to the **Control Panel**).
2. Double-click **Device Manager (Hardware and Sound > Devices and Printers > Device Manager)**.
3. Double-click the **device** you wish to update/reinstall the driver for (you may need to click “+” to expand the selection).
4. Click **Driver** (tab) and click the **Update Driver** or **Uninstall** button and follow the on screen prompts.

User Account Control

If a **User Account Control** prompt appears as part of the driver installation procedure, click **Continue** or **Allow**, and follow the installation procedure as directed.

Windows Security Message

If you receive a *Windows* security message as part of the driver installation process. Just click *“Install this driver software anyway”* or *“Install”* to continue the installation procedure.

You will receive this message in cases where the driver has been released after the version of *Windows* you are currently using. All the drivers provided will have already received certification for *Windows*.

New Hardware Found

If you see the message **“New Hardware Found”** during the installation procedure (**other than when outlined in the driver install procedure**), click **Cancel** to close the window, and follow the installation procedure.



Driver Installation General Guidelines

The driver installation procedure outlined in this Chapter (and in **Chapter 6 Options & Modules**), are accurate at the time of going to press.

Drivers are always subject to upgrade and revision so the exact procedure for certain drivers may differ slightly. As a general guide follow the default on screen instructions for each driver (e.g. **Next > Next > Finish**) unless you are an advanced user. In many cases a restart is required to install the driver.

Make sure any modules (e.g. WLAN or Bluetooth) are **ON** before installing the appropriate driver.

Driver Installation Procedure

Insert the *Device Drivers & Utilities + User's Manual* disc and click **Install Drivers** (button).

Chipset

1. Click **1.Install Chipset Driver > Yes**.
2. Click **Next > Accept > Install**.
3. Click **Finish**.

Video (VGA)

1. Click **2.Install VGA Driver > Yes**.
2. Click **Next > Yes > Next > Next**.
3. Click **Finish** to restart the computer.

Note: After installing the video driver go to the **Display/Display Settings** control panel to adjust the video settings to the highest resolution.

LAN

*Note: If the computer enters a deep sleep mode during installation, you will be prompted to plug in a network cable, and click **OK**, to continue installation. If a network cable is not available, restart the system and re-install the LAN driver.*

1. Click **3.Install LAN Driver > Yes**.
2. Click **Next > Install**.
3. Click **Finish**.

CardReader

1. Click **4.Install Cardreader Driver > Yes**.
2. Click **Finish**.

Touchpad

1. Click **5.Install Touchpad Driver > Yes**.
2. Click **Next**.
3. Click the button to accept the license agreement and click **Next**.
4. Click **Finish > Restart Now** to restart the computer.

Airplane

Note: Do not use Update Driver in Device Manager to install the Airplane Mode driver.

1. Click **6.Install Airplane Driver > Yes**.
2. Click **Next**.
3. Click **Finish** to restart the computer.

USB 3.0

1. Click **7.Install USB 3.0 Driver > Yes**.
2. Click **Next**.
3. Click the button to agree to the license agreement and click **Next**.
4. Click **Next > Next**.
5. Click **Finish** to restart the computer.

Intel TXE

1. Click **8.Install TXE Driver > Yes**.
2. Click **Next**.
3. Click the check box to accept the license agreement and click **Next**.
4. Click **Next > Finish**.

Hot Key

1. Click **9.Install Hotkey AP > Yes**.
2. Click **Next > Install**.
3. Click **Finish** to restart the computer.

Intel® DPTF Driver Installation

1. Click **10.Install DPTF Driver > Yes**.
2. Click **Next**.
3. Click **Yes** to accept the license.
4. Click **Next > Finish**.
5. See *“Intel® Dynamic Platform & Thermal Framework” on page 3 - 22* for details.

Audio

1. Click **11.Install Audio Driver > Yes**.
2. Click **Next**.
3. Click **Finish** to restart the computer.

Drivers & Utilities

Note that after installing the audio driver the system will not return to the *Drivers Installer* screen. To install any of the optional drivers listed overleaf, eject the *Device Drivers & Utilities + User's Manual* disc and then reinsert it (or double-click the disc icon in **My Computer**), and click **Option Drivers** (button) to access the optional driver menu.

4

Windows Update

After installing all the drivers make sure you enable **Windows Update** in order to get all the latest security updates etc. (all updates will include the latest **hotfixes** from Microsoft).

To enable **Windows Update** make sure you are connected to the internet:

1. Go to the **Control Panel**.
2. Click **Windows Update** (System and Security/Security).
3. Click **Check for updates** (button).
4. The computer will now check for updates (you need to be connected to the internet).
5. Click **Install now** (button) to begin checking for the updates.
6. Click **Install updates** (button) to install the updates.

Optional Drivers

See the pages indicated in *Table 4 - 1, on page 4 - 3* for the driver installation procedures for any modules included in your purchase option.

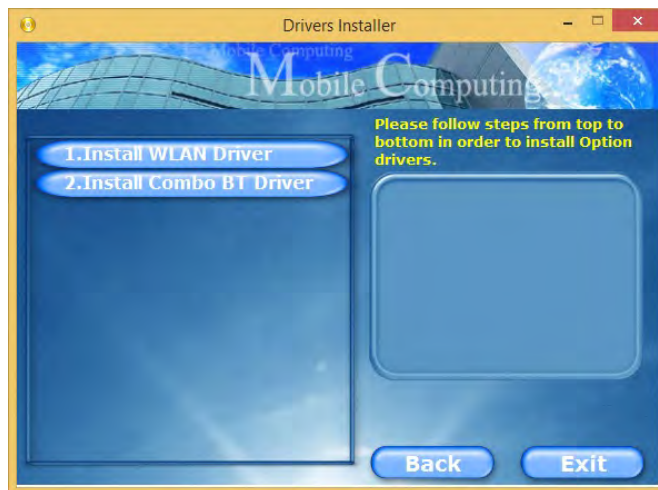

Figure 4 - 3 - Option Drivers

Note that you need to install both the WLAN & Bluetooth drivers for Intel and 3rd party WLAN & Bluetooth Combo modules.

Chapter 5: BIOS Utilities

Overview

This chapter gives a brief introduction to the computer's built-in software:

If your computer has never been set up, or you are making important changes to the system (e.g. hard disk setup), then you should review this chapter first and note the original settings found in *Setup*. Even if you are a beginner, keep a record of the settings you find and any changes you make. This information could be useful if your system ever needs servicing.

There is one general rule: *Don't make any changes unless you are sure of what you are doing*. Many of the settings are required by the system, and changing them could cause it to become unstable or worse. If you have any doubts, consult your service representative.



BIOS Screens

Note that the BIOS screens pictured on these pages are intended for guidance in setting up your system's BIOS.

BIOS versions are subject to constant change and revision, therefore your computer's actual screens may appear slightly different from those pictured on these pages.



BIOS Settings Warning

Incorrect settings can cause your system to malfunction. To correct mistakes, return to *Setup* and restore the **Optimized Defaults** with **<F3>**.

UEFI Boot & POST

When UEFI Boot is enabled, then the prompts to **press F2 or F7** will **not appear**. However you can still press F2 to enter the setup, or F7 to choose the preferred boot device, if you press the key immediately the system boots up.

The Setup Utility

Each time you turn on the computer the system takes a few seconds to conduct a **POST**, including a quick test of the on-board RAM (memory).

As the **POST** proceeds, the computer will tell you if there is anything wrong. If there is a problem that prevents the system from booting, it will display a system summary and prompt you to run *Setup*.

If there are no problems, the *Setup* prompt will disappear and the system will load the operating system. Once that starts, you can't get into *Setup* without rebooting.

The **Aptio Setup Utility** tells the system how to configure itself and manage basic features and subsystems (e.g. port configuration).

To enter *Setup*, turn on the computer and press **F2** (give the system a few seconds to enter *Setup*). If the **Boot Logo** is enabled the **F2** on screen will be **highlighted** to illustrate that the system is processing the request during the **POST** (or press **F7** for boot options). If you get a “Keyboard Error”, (usually because you pressed **F2** too quickly) just press **F2** again.

If the computer is already on, reboot using the **Ctrl + Alt + Delete** combination and then hold down **F2** when prompted. The *Setup* main menu will appear.

To see the boot options press **F7** and choose your preferred boot device.

Failing the POST

Errors can be detected during the **POST**. There are two categories, “fatal” and “non-fatal”.

Fatal Errors

These stop the boot process and usually indicate there is something seriously wrong with your system. Take the computer to your service representative or authorized distributor/supplier as soon as possible.

Non-Fatal Errors

This kind of error still allows you to boot. You will get a message identifying the problem (make a note of this message!) and you can then press **F7** (the **F7** on screen will be **highlighted** to illustrate that the system is processing the request) for boot options.

Press **F2** (give the system a few seconds to enter *Setup*; the **F2** on screen will be highlighted to illustrate that the system is processing the request) to run the **Setup** program and try to correct the problem. If you still get an error message after you change the setting, or if the “cure” seems even worse, call for help.



Setup Menu

The **Setup** menus shown in this section are for **reference** only. Your computer's menus will indicate the configuration appropriate for your model and options.

Figure 5 - 1
Navigation Menu

Setup Screens

The following pages contain additional advice on portions of the *Setup*. Along the top of the screen is a menu bar with menu headings. When you select a heading, a new screen appears. Scroll through the features listed on each screen to make changes to *Setup*.

Instructions on how to navigate each screen are in the box at the bottom right side of the screen.

```
→←:Select Screen  
↑↓:Select Item  
Enter: Select  
+/-: Change Opt.  
F1: General Help  
F3: Optimized Defaults  
F4: Save Changes & Exit  
ESC: Exit
```

If these tools are confusing, press **F1** to call up a **General Help** screen, and then use the arrow keys to scroll up or down the page.

The **Item Specific Help** on the upper right side of each screen explains the highlighted item and has useful messages about its options.

If you see an arrow ► next to an item, press **Enter** to go to a sub-menu on that subject. The sub-menu screen that appears has a similar layout, but the **Enter** key may execute a command.

Main Menu

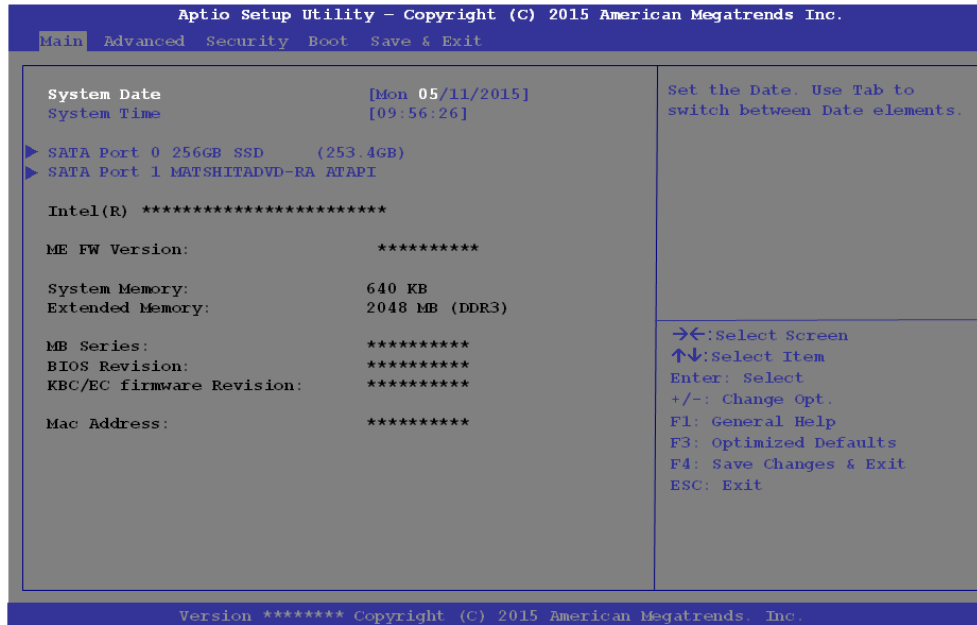

Figure 5 - 2
Main Menu

System Time & Date (Main Menu)

The hour setting uses the 24-hour system (i.e., 00 = midnight; 13 = 1 pm). If you can change the date and time settings in your operating system, you will also change these settings. Some applications may also alter data files to reflect these changes.

SATA Port # (Main Menu)

Pressing **Enter** opens the sub-menu to show the configuration of a optical Device/HDD on the computer's SATA Ports.

System/Extended Memory: (Main Menu)

This item contains information on the system memory, and is not user configurable. The system will auto detect the amount of memory installed.

MB Series / BIOS Revision / KBC/EC firmware Revision / MAC Address

This item contains information on the BIOS version, network adapter address etc., and is not user configurable.

Advanced Menu



Figure 5 - 3
Advanced Menu

Advanced Chipset Control (Advanced Menu)

The sub-menu here allows you to enable/disable the **FlexiCharger** (see page 5 - 9) and to enable/disable **Aggressive LPM Support**. Aggressive Link Power Management (ALPM) is a power management protocol for AHCI and SATA devices. This allows the SATA host bus adapter to enter a low-power state during periods of inactivity when enabled.



UEFI Boot

When UEFI Boot is enabled, then the prompts to press **F2** or **F7** will not appear. However you can still press **F2** to enter the setup, or **F7** to choose the preferred boot device, if you press the key immediately the system boots up.

SATA Mode (Advanced Menu)

The SATA (Serial ATA) control is configured to operate in **AHCI** (Advanced Host Controller Interface) mode.

Boot Logo (Advanced Menu)

Use this menu item to enable/disable the **Boot Logo** screen at system startup **if you have not enabled UEFI Boot**. If you disable the **Boot Logo** you will not see the **F2 Enter Setup** or **F7 Boot Options** prompts on the screen, however you can still press these keys, while the boot screen is displayed, to perform the Enter Setup or Boot Option functions.

Power On Boot Beep (Advanced Menu)

Use this menu item to enable/disable the beep as the computer starts up.

Battery Low Alarm Beep (Advanced Menu)

Use this menu item to enable/disable the battery low alarm beep.

FlexiCharger Enable (Advanced Menu > Advanced Chipset Control)

The sub-menu here allows you to enable/disable the **FlexiCharger**. The Battery Engine may be set to automatically start charging your battery when the battery reaches a certain capacity level (e.g. you could start the battery charge level at 40%).

You can then set the level to stop charging (e.g. 100%), and of course this stop charge level must be higher then the start charge level.

See the sidebar warning for information on running the FlexiCharger for an extended period as this is not recommended.

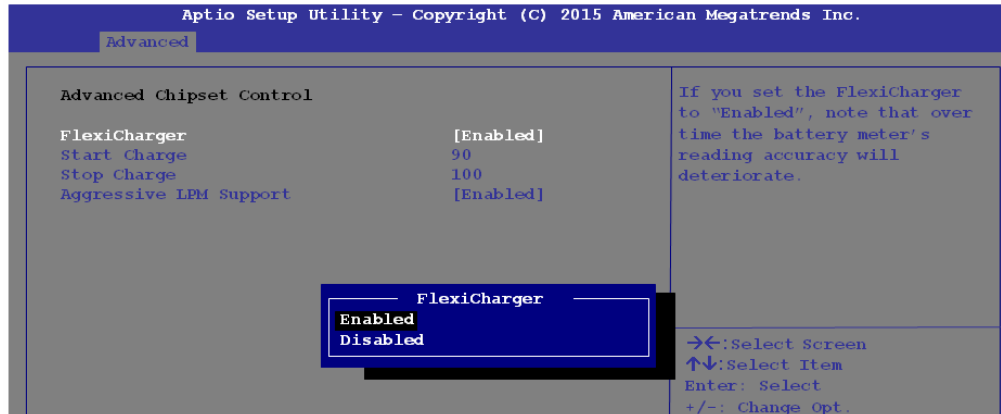



FlexiCharger Warning

If you leave the FlexiCharger continuously "Enabled" for a period of three months or more, the battery meter's reading accuracy will deteriorate.

To reset this, set the FlexiCharger to "Disabled", and then allow the battery to completely discharge (see "[Battery FAQ](#)" on page 3 - 18) before enabling the function again.

Figure 5 - 4
Advanced Chipset Control > FlexiCharger

Security Menu



Security Menu

The changes you make here affect the access to the **Setup** utility itself, and also access to your machine as it boots up after you turn it on. These settings do not affect your machine or network passwords which will be set in your software OS.

5

Figure 5 - 5 Security Menu

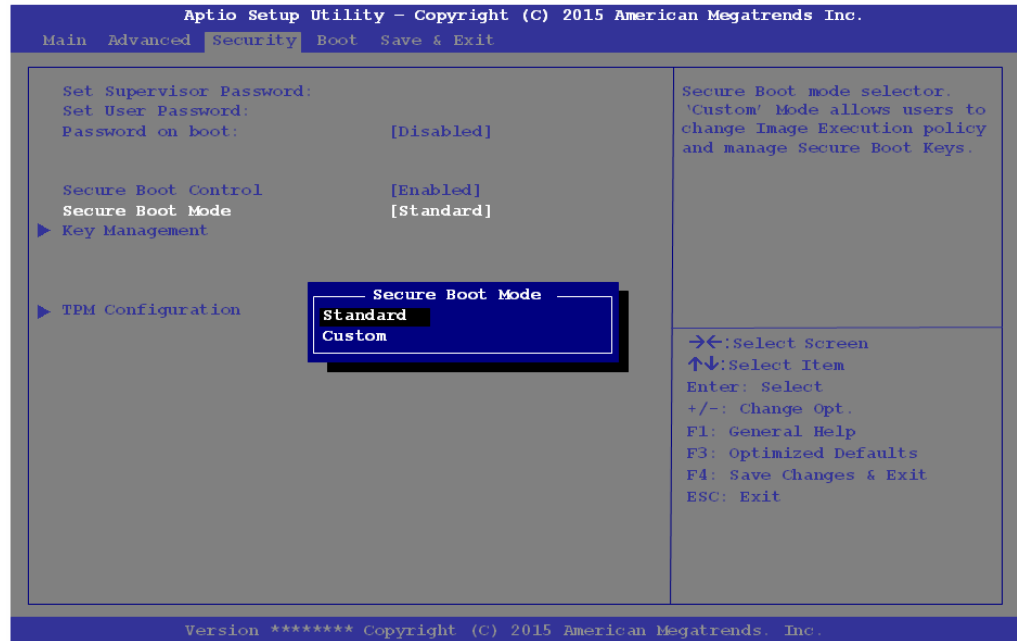

Set Supervisor Password (Security Menu)

You can set a password for access to the **Aptio Setup Utility**. This will not affect access to the computer OS (only the **Aptio Setup Utility**).

Note: To clear existing passwords press **Enter** and type the existing password, then press **Enter** for the new password (without typing any password entry) and **Enter** again to confirm the password clearance.

Set User Password (Security Menu)

You can set a password for user mode access to the **Aptio Setup Utility**. This will not affect access to the computer OS, (only the *Setup* utility) unless you choose to set a **Password on Boot** (see below). Many menu items in the **Aptio Setup Utility** cannot be modified in user mode.

Note: *You can only set the user password after you have set the supervisor password.*

Password on boot: (Security Menu)

Specify whether or not a password should be entered to boot the computer (**you may only set a password on boot if a supervisor password is enabled**). If “*Enabled*” is selected, only users who enter a correct password can boot the system (**see the warning in the sidebar**). The default setting is “*Disabled*”.



Password Warning

If you set a boot password (Password on boot is “Enabled”), **NEVER** forget your password.

The consequences of this could be serious. If you cannot remember your boot password you must contact your vendor and you may lose all of the information on your hard disk.

Secure Boot Control (Security Menu)

Secure Boot prevents unauthorized operating systems and software from loading during the startup process. **Secure Boot** is available as a menu option if you have **enabled UEFI Boot** (see *“UEFI Boot (Boot Menu)” on page 5 - 15*). Enabling Secure Boot will bring up the **Secure Boot Mode** menu to enable you to configure Secure Boot as **Standard** (with a fixed secure boot policy) or **Custom** (which enables you to make changes to the **Key Management** database if required).



Figure 5 - 6
Security -
Secure Boot
(Key Management)

TPM Configuration (Security Menu)

This sub-menu will allow you to enable/disable Trusted Platform Module (TPM) support. Press Enter to access the **Security Device Support** menu and select **Enable** to support TPM as long as UEFI Boot is enabled (see *“Trusted Platform Module” on page 6 - 27* for details).



TPM Menu Item Settings

You will need to check with your IT administrator for the actual TPM settings required within your organization.

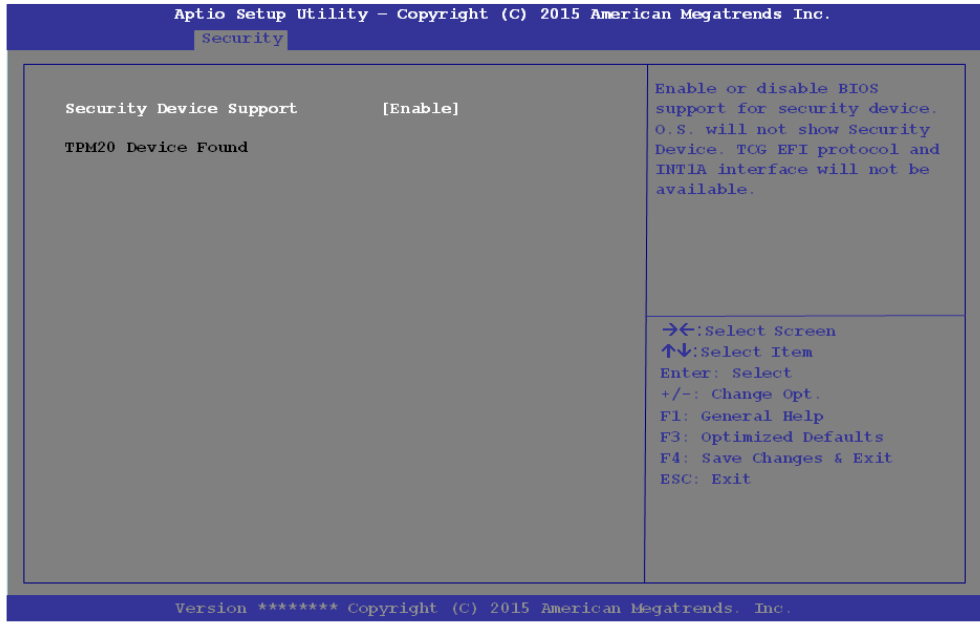

Figure 5 - 7 Security Device Support

Boot Menu

Figure 5 - 8
Boot Menu

5



BIOS Screens

Note that the BIOS screens pictured on these pages are intended for guidance in setting up your system's BIOS.

BIOS versions are subject to constant change and revision, therefore your computer's actual screens may appear slightly different from those pictured on these pages.

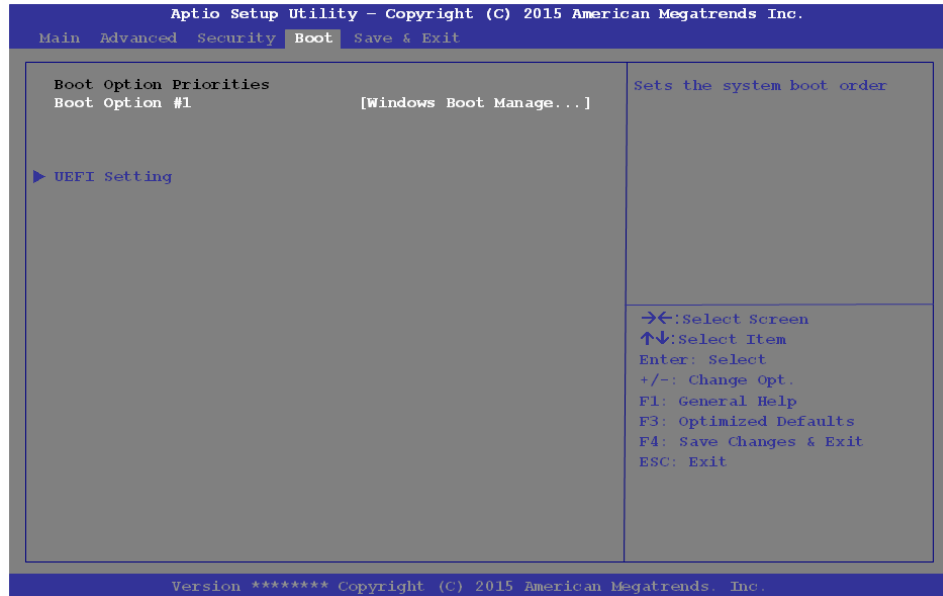

When you turn the computer on it will look for an operating system (e.g. **Windows 7**) from the devices listed in this menu, and **in this priority order**. If it cannot find the operating system on that device, it will try to load it from the next device in the order specified in the **Boot Option Priorities**. Item specific help on the right is available to help you move devices up and down the order.

Boot Option Priorities (Boot Menu)

Press Enter to access the menu, use the arrow keys to move up and down the menu, and press Enter to select a device from the **Boot Option #** list (the selected device will be highlighted in white).

UEFI Boot (Boot Menu)

Enable/disable UEFI Boot from this menu. The Unified Extensible Firmware Interface (UEFI) specification provides a clean interface between operating systems and platform firmware at boot time. In contrast to BIOS, UEFI defines a set of standard boot and runtime services. The *Network Stack* and *Launch CSM (Compatibility Support Module)* - for legacy BIOS compatibility) items will be enabled as options under UEFI Boot.

Exit Menu

Figure 5 - 9
Exit Menu



Click *Save Changes and Reset* to save all changes made. Choosing to *Discard Changes*, or *Exit Discarding Changes*, will wipe out any changes you have made to the *Setup*. You can also choose to restore the original *Setup* defaults that will return the *Setup* to its original state, and erase any previous changes you have made in a previous session.

Chapter 6: Modules & Options

Overview

This chapter contains information on the following modules, which may come with your computer, depending on the configuration purchased. If you are unsure please contact your service representative.

- PC Camera Module
- Wireless LAN Module
- Bluetooth & WLAN Combo Module
- 3G/4G Module
- Trusted Platform Module
- Wireless Display

Note that the information included on the following pages is for *Windows 8.1 only*. For *Windows 10* driver installation see “*Windows 10 Drivers & Utilities*” on page *E - 15*.



Wireless Device Operation Aboard Aircraft

The use of any portable electronic transmission devices aboard aircraft is usually prohibited. Make sure the **WLAN & Bluetooth module(s)** are **OFF** (or the system is in **Airplane Mode**) if you are using the computer aboard aircraft (see *Table 1 - 4*, on page *1 - 14*).

PC Camera Module

When the PC Camera application is run the LED indicator to the left of the camera will be illuminated (see [2 Figure 1 - 2 on page 1 - 7](#)). Note that you need to use the **Camera** app in *Windows* to take pictures and capture video. **Use the Fn + F10 key combination** (see [“Function/Hot Key Indicators” on page 1 - 14](#)) to **toggle power to the PC Camera module**.

PC Camera Audio Setup

If you want to capture video & **audio** with your camera, it is necessary to setup the audio recording options in *Windows*.

1. Go to the **Control Panel**.
2. Click **Sound**  (**Hardware and Sound**) and click **Recording** (tab).
3. Right-click hold and release **Microphone** (Realtek High Definition Audio) and make sure the item is not disabled.
4. Double-click **Microphone** (or select **Properties** from the right-click menu).
5. Click **Levels** (tab), and adjust the **Microphone** and **Microphone Boost** sliders to the level required.
6. Click **OK** and close the control panels.

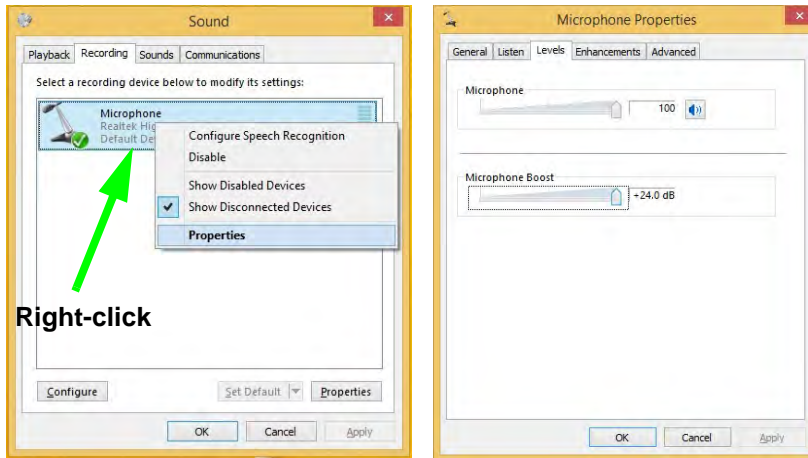

Figure 6 - 1
Audio Setup for PC
Camera

Camera App



1. Run the **Camera** app from the Start screen by clicking on the **Camera** app icon .
2. The camera interface will display two buttons on the right side of the screen.

Figure 6 - 2
Camera App Buttons



3. The upper button  is used to record video, and the lower button  is used to take still pictures.
4. **Right-click** on the screen to bring up menu buttons at the bottom of the screen.
5. These buttons enable you to access the **camera roll** (where captured pictures and video are displayed), set the **timer** (the time period before capture begins; 3 seconds, 10 seconds or Off) and set the exposure level using the slider to obtain the best results.

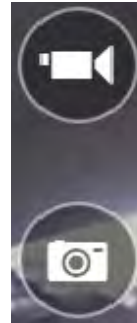
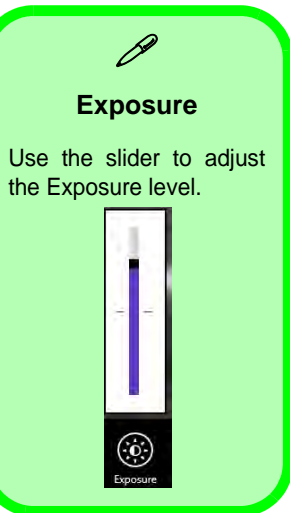



Figure 6 - 3
Camera Options

Camera Options

The **Camera Options** settings may be accessed as follows:

1. Run the **Camera** app from the **Start** screen by clicking on the **Camera** app icon .
2. While the camera app is running access the **Charms Bar** (e.g. click Use the **Windows** logo key  + **C** key combination).
3. Click **Settings** and then click **Options**.
4. You can adjust the **Photo Aspect Ratio**, select the **Microphone**, **Hide/Show** grid lines and turn Location Info on or off from the **Options** panel.

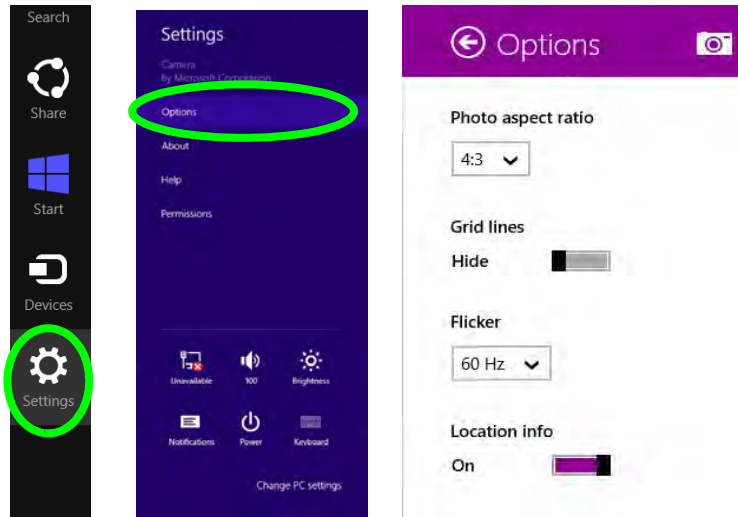



Figure 6 - 4
Camera Options

Taking Pictures/Capturing Video



1. Run the **Camera** app from the **Start** screen by clicking on the **Camera** app icon .
2. Right-click the screen and select the timer if you require a countdown before capture.
3. Click the appropriate icon to take a picture or start video capture (if video capture begins a timer will appear in the bottom corner of the screen).
4. To stop video capture click the main window again (or click the stop icon ).
5. Captured photos and videos will be saved to a **Camera Roll** folder within the **Pictures** folder.

6

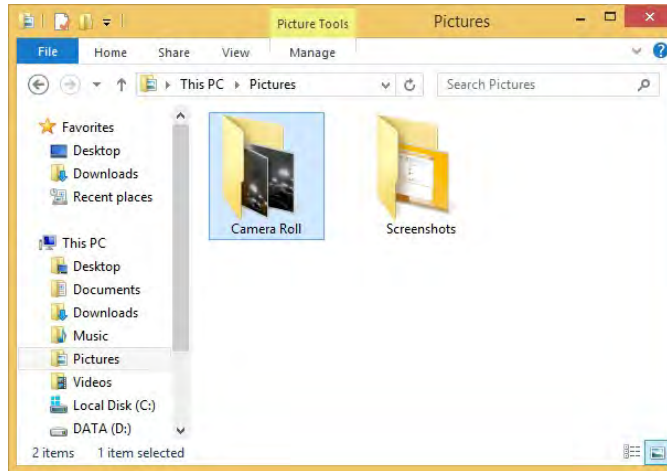
Figure 6 - 5
**Pictures - Camera
Roll**



Camera Roll

1. Run the **Camera** app from the **Start** screen by clicking on the **Camera** app icon .
2. **Right-click** on the screen to bring up menu buttons at the bottom of the screen.
3. Click **Camera Roll**.
4. Click the arrows  /  (on either side of the screen) to browse through the captured photos/video, and back to the Camera app.

Editing Photos

1. Clicking on a **captured photo** will bring up an app bar with a series of buttons.



Figure 6 - 6
Edit Buttons
 (for Still Photos)

2. The **Camera** button will take you back to the home screen of the camera app.
3. Click **Delete** to remove any photo from the camera roll (you will be asked to click **Delete** again to confirm the deletion).
4. The **Open With** button will allow you to select a program with which to open the photo.
5. You can click **Set as Lock screen** to set the photo as the lock screen picture.
6. Clicking **Slide Show** will create a slide show of photos/video in the camera roll.
7. Click **Rotate** to rotate the picture through 90 degrees.
8. Use the handles to **Crop** any captured picture, and click **Apply** to make the changes (you can change the **Aspect** ratio by clicking the button and selecting an aspect ratio from the menu). You can **Save a copy** (create another copy of the

photo with the edited changes), **Update original** (which changes the original picture permanently) or **Undo** any changes.

- Click the **Edit** button to bring up a full suite of tools to edit the photo.
- Click on the menu headings on the left, and then click on the tool on the right to edit the photo as required.

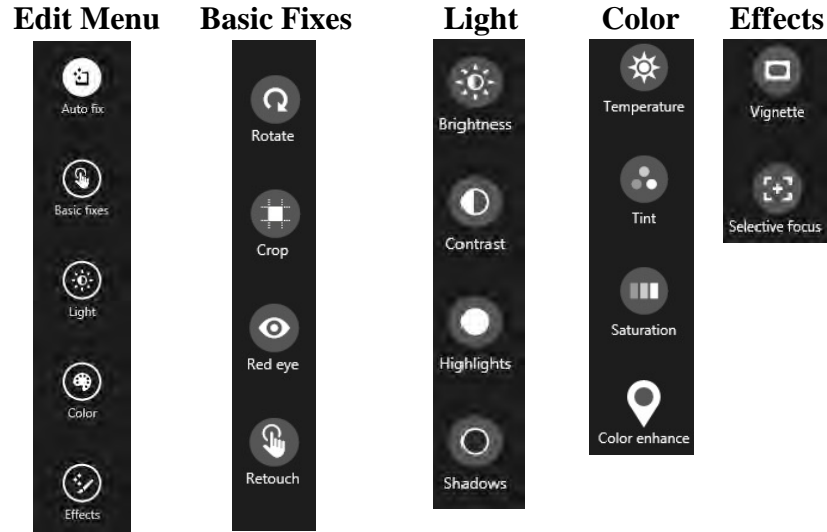

Figure 6 - 7
Editing Tools

- After the editing process is completed right-click on the photo to **Save a copy** (create another copy of the photo with the edited changes), **Update original** (which changes the original picture permanently), **Undo** any changes or **Cancel** the editing.

Editing Photos

1. Clicking on a **captured video** will bring up an app bar with a series of buttons.



Figure 6 - 8
Edit Buttons
(for Video)

2. Click **Delete** to remove any video from the camera roll (you will be asked to click **Delete** again to confirm the deletion).
3. The **Open With** button will allow you to select a program with which to run the Video.
4. Clicking **Slide Show** will create a slide show of photos/video in the camera roll.
5. Click **Trim** to edit the video. Use the round buttons at either end of the slider to adjust the video length and click **Save a copy** to save the changes made.

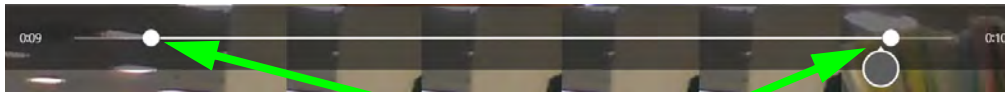

Click to select and move the rounded buttons to edit the video.

Figure 6 - 9
Trim Video
(for Video Files)

Video File Size

Note that capturing high resolution video files requires a substantial amount of disk space for each file. After recording video, check the video file size (right-click the file and select **Properties**) and the remaining free space on your hard disk (go to **My Computer**, right-click the hard disk, and select **Properties**). If necessary you can remove the recorded video file to a removable medium e.g. CD, DVD or USB Flash drive.

Note that the *Windows 8.1* system requires a minimum of **16GB (32-bit)** or **20GB (64-bit)** of free space on the **C: drive** system partition. In order to prevent system problems it is recommended that you move any large sized captured video file to a location other than the **C: drive**.

Wireless LAN Module

If you have included an **Intel®** or **3rd Party WLAN** module in your purchase option make sure that the module is on (i.e. the system is not in **Airplane Mode**) before installing the driver.

Make sure you install the drivers in the order indicated in *Table 4 - 1, on page 4 - 3*.

Note that you need to install both the WLAN & Bluetooth drivers for the WLAN & Bluetooth Combo modules.



Wireless Device Operation Aboard Aircraft

The use of any portable electronic transmission devices aboard aircraft is usually prohibited. Make sure the **WLAN & Bluetooth module(s)** are **OFF** if you are using the computer aboard aircraft by putting the system in to **Airplane Mode** (see *Table 1 - 4, on page 1 - 14*).

3rd Party 802.11b/g/n Driver Installation

1. **Make sure the system is not in Airplane Mode**, and then insert the *Device Drivers & Utilities + User's Manual* disc into the DVD drive.
2. Click **Option Drivers** (button).
3. Click **1.Install WLAN Driver > Yes**.
4. Click **Next**.
5. Click **Finish** to restart the computer.
6. The operating system is the default setting for Wireless LAN control in *Windows* (see page [6 - 13](#)).

Intel® WLAN Driver Installation

1. **Make sure the system is not in Airplane Mode**, and then insert the *Device Drivers & Utilities + User's Manual* disc into the DVD drive.
2. Click **Option Drivers** (button).
3. Click **1.Install WLAN Driver > Yes**.
4. Click in the check box to agree to the **End User License Agreement** and click **Install**.
5. Click **Finish**.
6. The operating system is the default setting for Wireless LAN control in *Windows* (see page [6 - 13](#)).

WLAN Configuration in Windows

You can configure a wireless connection using one of the following options, however make sure the Wireless LAN module is turned on (and not in Airplane Mode) before configuration begins.

Charms Bar

1. Go to the **Charms Bar**.
2. Select **Settings** and then click the **WiFi icon** (it should read **Available** under the icon and **Airplane mode** should be **Off**).
3. A list of available access points will appear.

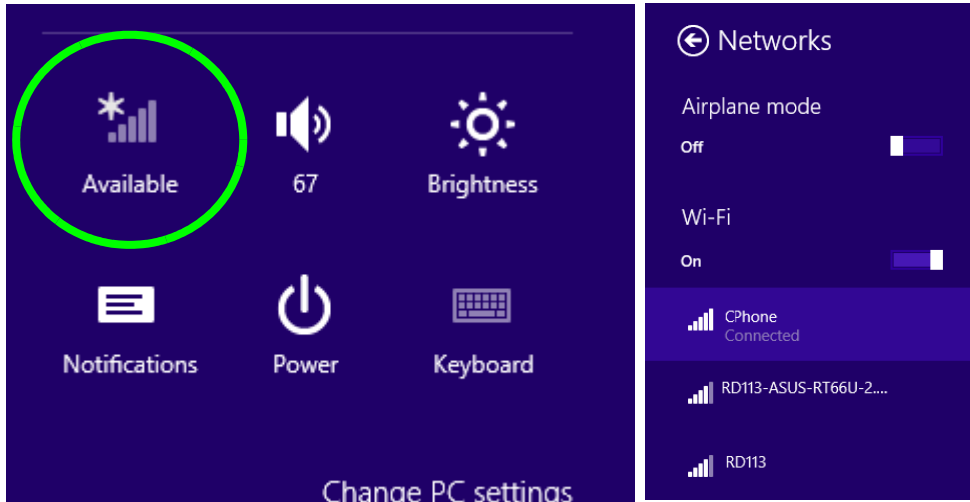



Figure 6 - 10
WiFi Settings
(Charms Bar) &
Networks

Modules & Options

4. Double-click an access point to connect to it (or click it and click **Connect**).
5. Enter a network security key (password) if required, and click **Next**.
6. You can choose to find other devices or not.
7. When you are connected to the network access point it will display **Connected** .
8. Select any connected network and click **Disconnect**  to disconnect from a connected access point.

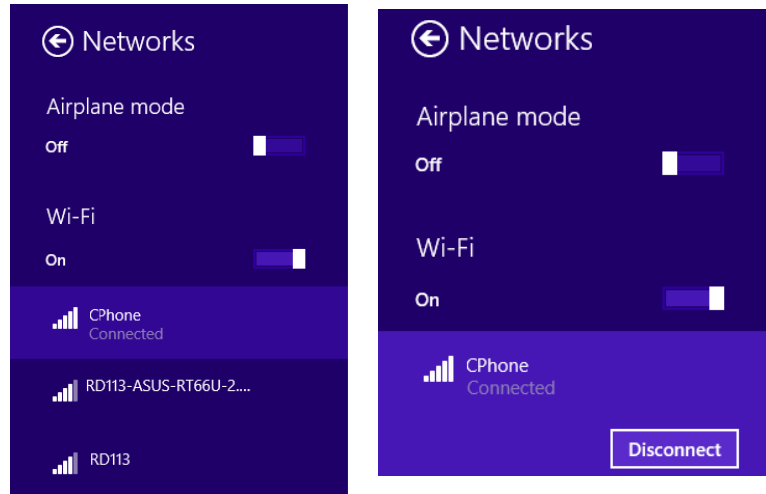



Figure 6 - 11
Networks
Connected /
Disconnect

9. You can click the **Airplane Mode** button to turn the mode (including Bluetooth) On or Off.
10. Alternatively you can click the **WiFi** button to turn just the WiFi On or Off.

Desktop Mode

1. Switch to the Windows Desktop (click the app or use the Windows logo key  + **D** key combination).
2. Click the wireless icon  in the notification area of the taskbar.
3. A list of available access points will appear.
4. Double-click an access point to connect to it (or click it and click **Connect**).
5. Enter a network security key (password) if required, and click **Next**.
6. You can choose to find other devices or not.
7. Select any connected network and click **Disconnect** to disconnect from a connected access point.

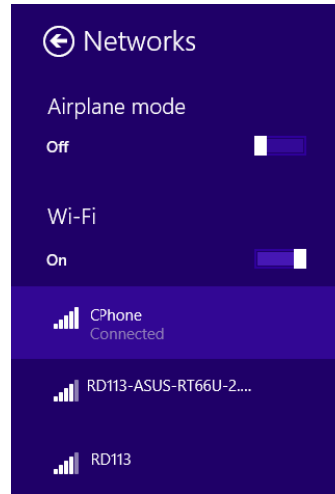
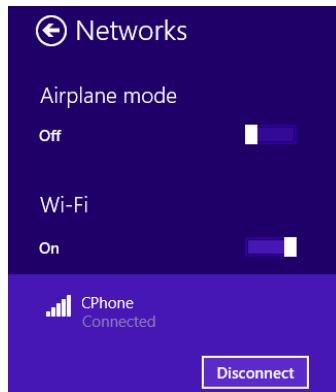
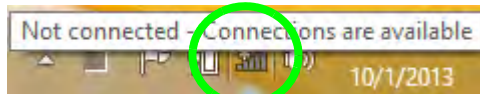

Figure 6 - 12
Windows Desktop
Taskbar Notification
Area WLAN
Connection



Wireless Device Operation Aboard Aircraft

The use of any portable electronic transmission devices aboard aircraft is usually prohibited. Make sure the **WLAN & Bluetooth module(s)** are **OFF** if you are using the computer aboard aircraft by putting the system in to **Airplane Mode** (see [Table 1 - 4, on page 1 - 14](#)).

Bluetooth & WLAN Combo Module

If your purchase option includes the **Combination Wireless LAN & Bluetooth module** (either **Intel®** or **3rd Party**) then install the driver as instructed overleaf.

Make sure that the module is on (i.e. the system is not in **Airplane Mode**) before installing the driver.



Bluetooth Data Transfer

Note that the transfer of data between the computer and a Bluetooth enabled device is supported in one direction only (simultaneous data transfer is not supported). Therefore if you are copying a file from your computer to a Bluetooth enabled device, you will not be able to copy a file from the Bluetooth enabled device to your computer until the file transfer process from the computer has been completed.

3rd Party Bluetooth (V4.0) Combo Driver Installation

1. **Make sure the system is not in Airplane Mode**, and then insert the *Device Drivers & Utilities + User's Manual* disc into the DVD drive.
2. Click **Option Drivers** (button).
3. Click **2.Install Combo BT Driver > Yes**.
4. Click **Next**.
5. Click **Finish** to restart the computer.
6. See *“Bluetooth Configuration in Windows” on page 6 - 18* for configuration instructions.

Intel Bluetooth Combo Driver Installation

1. **Make sure the system is not in Airplane Mode**, and then insert the *Device Drivers & Utilities + User's Manual* disc into the DVD drive.
2. Click **Option Drivers** (button).
3. Click **2.Install Combo BT Driver > Yes**.
4. Click **Next > Next**.
5. Click in the check box to accept the license and click **Next**.
6. Choose the setup type (**Typical** is recommended) and click **Install**.
7. Click **Finish**.
8. See *“Bluetooth Configuration in Windows” on page 6 - 18* for configuration instructions.



High Speed Bluetooth Data Transfer

The **Combination Wireless LAN & Bluetooth module** supports high speed data transfer. However to achieve such transfer speeds, **both devices must support high speed data transfer**.

To obtain high speed data transfer make sure that both the **WLAN and Bluetooth modules are powered on**.

Check your Bluetooth compatible device's documentation to confirm it supports high speed data transfer.





Bluetooth Headset Stereo Setup

To setup a Bluetooth headset to support stereo audio see page 7 - 14.

Bluetooth Configuration in Windows

You can configure a Bluetooth connection as below, however make sure the Bluetooth module is on (or the system is not in Airplane Mode) before configuration.

Desktop Mode

1. Switch to the Windows Desktop (click the App or use the Windows logo key  + **D** key combination).
2. Click the notification area of the taskbar and double-click the Bluetooth icon  (or click and select **Show Bluetooth Devices**).
3. The **Bluetooth** item in **PC and Devices** will appear.

OR

Charms Bar

1. Go to the **Charms Bar**.
2. Select **Settings** and then click **Change PC Settings**.
3. Select the **Bluetooth** item in **PC and Devices**.

Figure 6 - 13
Bluetooth Taskbar Icon & Change PC Settings (Charms Bar -Settings)

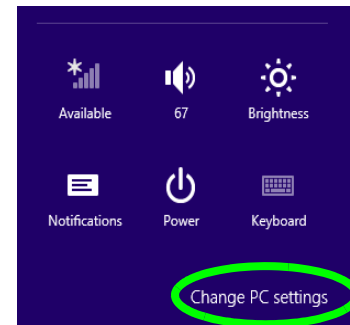
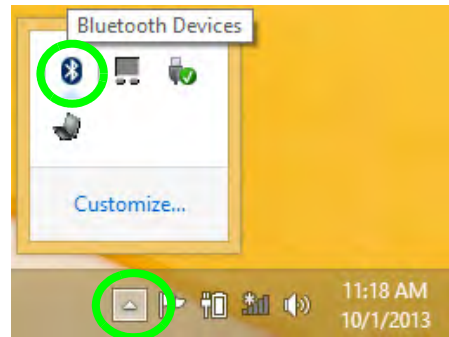

4. Make sure that Bluetooth is turned on and a list of discovered devices will appear.
5. Double-click the device you want to pair with the computer and click **Pair**.

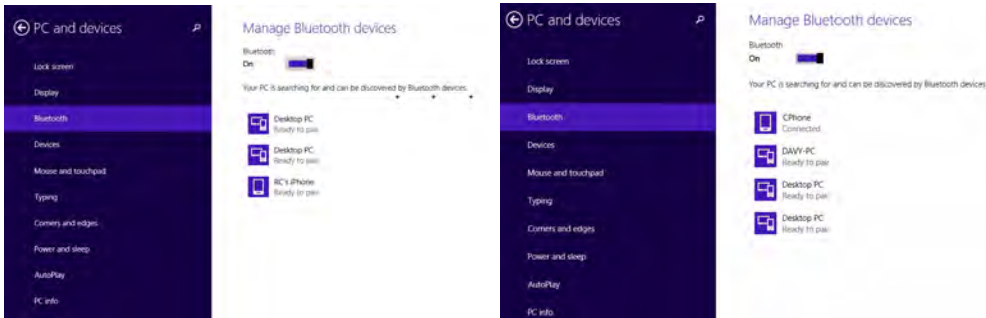

Figure 6 - 14
PC and Devices - Bluetooth

6. On first connection the computer will provide you with a pairing code to be entered onto the device.

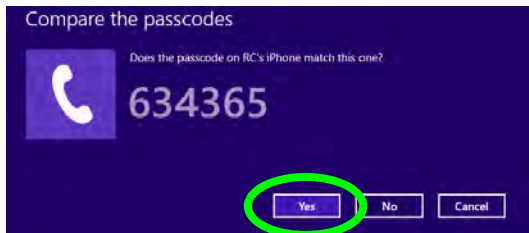



Figure 6 - 15
Enter the Passcode

7. Enter the code into your Bluetooth enabled device and click **Yes** on the computer to complete the pairing.
8. Select a device and click **Remove Device** to disconnect from any device.

To Make your Computer Discoverable to Bluetooth Devices

1. Switch to the Windows Desktop (click the app or use the Windows logo key  + **D** key combination).
2. Click the notification area of the taskbar, click the Bluetooth icon  and click **Open Settings**.
3. Click **Options**, and make sure that **Allow Bluetooth devices to find this computer** check box (**Discovery**) has a check inside it.
4. Make sure that the **Alert me when a new Bluetooth device wants to connect** check box (**Connections**) has a check inside it, if you want to be notified when a Bluetooth device wants to connect.

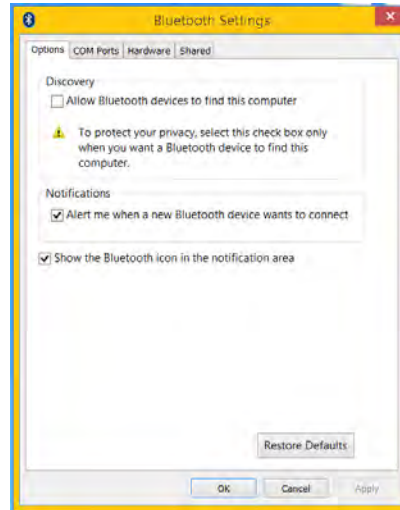

Figure 6 - 16
Bluetooth Settings

3G/4G Module

If you have included an **optional UMTS/HSPA+** based 3G Module (Universal Mobile Telecommunications System or High Speed Packet Access) module or **LTE** (Long Term Evolution) 4G module (see **“Communication” on page D - 3** for specification details) in your purchase option, ***you do not require a driver/application installation for Windows***. Follow the instructions overleaf to install the USIM card (which will be supplied by your service provider) for **Model B** computers (installing the USIM card for **Model A** computers will require assistance from your distributor/supplier - see page **6 - 23**), and then **use the Charms Bar Wireless icon to access the 3G/4G network** in the same manner as the WLAN.



Important Notice

If your purchase option includes both Wireless LAN and 3G/4G modules, then the appropriate antennas will be installed. Note that in order to comply with FCC RF exposure compliance requirements, the antenna must not be co-located or operate in conjunction with any other antenna or transmitter.

Important Notice - 3G/4G & Bluetooth/Wireless LAN Modules

In order to comply with FCC regulations you should NOT operate the 3G/4G module and the Bluetooth/Wireless LAN modules at the same time as this may disrupt radio frequency, and cause interference. When the 3G/4G module is powered on, make sure that the Bluetooth/Wireless LAN modules are powered off.



Wireless Device Operation Aboard Aircraft

The use of any portable electronic transmission devices aboard aircraft is usually prohibited. Make sure the **WLAN & Bluetooth module(s) are OFF** (or the system is in **Airplane Mode**) if you are using the computer aboard aircraft (see **Table 1 - 4, on page 1 - 14**).

Modules & Options



Power Safety Warning

Before you undertake any installation procedures, make sure that you have turned off the power, and disconnected all peripherals and cables (including telephone lines).

USIM Card Orientation

Note that the USIM card's readable side (with the gold-colored contacts) should face downwards as illustrated.

Figure 6 - 17
**Battery Removal &
USIM Card Insertion
Model B**

3G/4G Module USIM Card Installation for Model B Computers

Follow the instructions below to install the USIM card (which will be supplied by your service provider).

1. Turn the computer **off**, and turn it over.
2. Slide the latch **1** in the direction of the arrow.
3. Slide the latch **2** in the direction of the arrow, and hold it in place.
4. Slide the battery out in the direction of the arrow **3**.
5. Insert the USIM card **4** as illustrated below until it clicks fully into position, and replace the battery.

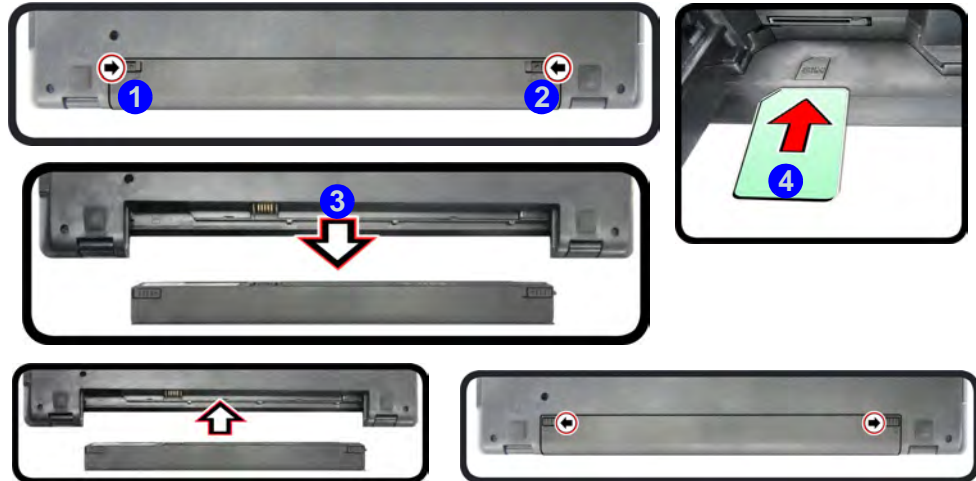

3G/4G Module USIM Card Installation for Model A Computers

Contact your distributor/supplier for assistance on installing the USIM card for **Model A** computers, as removing the bottom cover of the computer can void your warranty.



3G/4G Module PIN Code & Power-Saving

Note that there may be some issues when a PIN Code is set for 3G/4G modules in Windows, if Mobile Broadband has been turned off, and the system has resumed from a power-saving state. See “[3G/4G Module PIN Code & Power-Saving](#)” on page 7 - 15.

3G/4G Configuration in Windows

You can configure a 3G/4G connection as below, however make sure the system is not in Airplane Mode before configuration begins.

Charms Bar

1. Go to the **Charms Bar**.
2. Select **Settings** and then click the **WiFi icon** (it should read **Available** under the icon and **Airplane mode** should be **Off**).
3. A list of available access points will appear under Mobile Broadband.

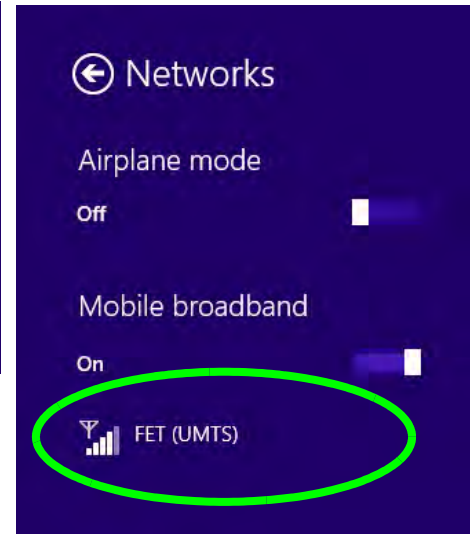
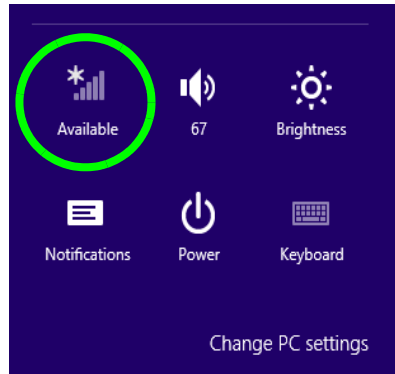

Figure 6 - 18
Networks
Mobile Broadband

4. Any 3G/4G service provider (connection information is usually stored on the USIM card) will appear under Mobile Broadband.
5. Double-click any connection icon under Mobile Broadband (or click and then click **Connect**).

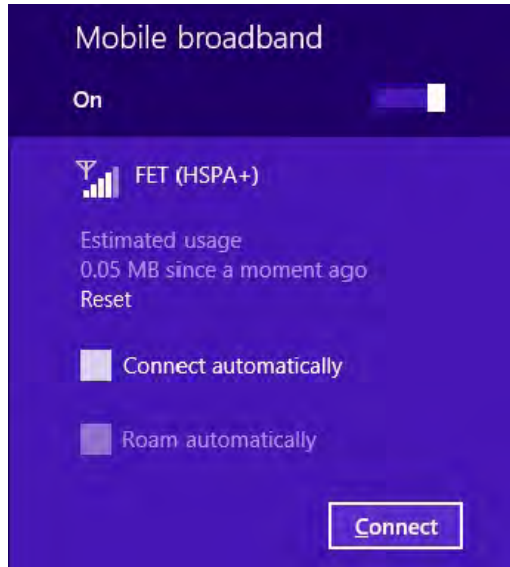

Figure 6 - 19
Mobile Broadband
(Connect)

6. The system will connect to your network.
7. A **Connected** will appear alongside the 3G/4G connection (click the connection to view the timer which indicates your connected time for the current session).

Modules & Options



Wireless Device Operation Aboard Aircraft

The use of any portable electronic transmission devices aboard aircraft is usually prohibited.

Make sure the system is in **Airplane Mode** if you are using the computer aboard aircraft.

8. You can then access the internet, download e-mail etc. as per any internet connection.
9. To disconnect you can select the connection and click **Disconnect** .

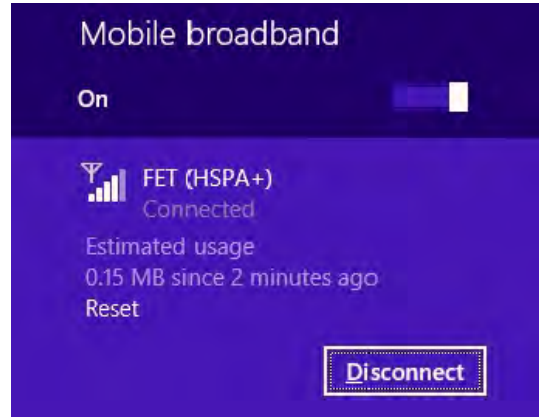

10. You need to either use **Airplane Mode**, or to **turn the Mobile Broadband module off** aboard aircraft.

Figure 6 - 20
**Mobile Broadband
(Disconnect)**

Trusted Platform Module

(Optional)

The **TPM security chip** allows you to create and manage digital certificates for user and platform authentication. This type of security is usually administered within large enterprises and organizations, and therefore requires implementation by a system administrator before users can access security features.

Make sure you have administrator's rights to your computer, and have a *Windows* password enabled for full security protection. In addition **Make sure you prepare a removable media (e.g. a USB flash drive) to store passwords etc. before beginning the TPM initialization process.**

Before setting up the TPM functions you must enable and initialize the security platform.

Enabling & Activating TPM

1. Restart the computer.
2. Enter the **Aptio Setup Utility** pressing **F2** during the POST/startup.
3. Use the arrow keys to select the **Security** menu.
4. Select **TPM Configuration** and press Enter to access the sub-menu.
5. Select **Enable** in **Security Device Support**.
6. You will then need to press **F4** to save the changes and restart the computer.

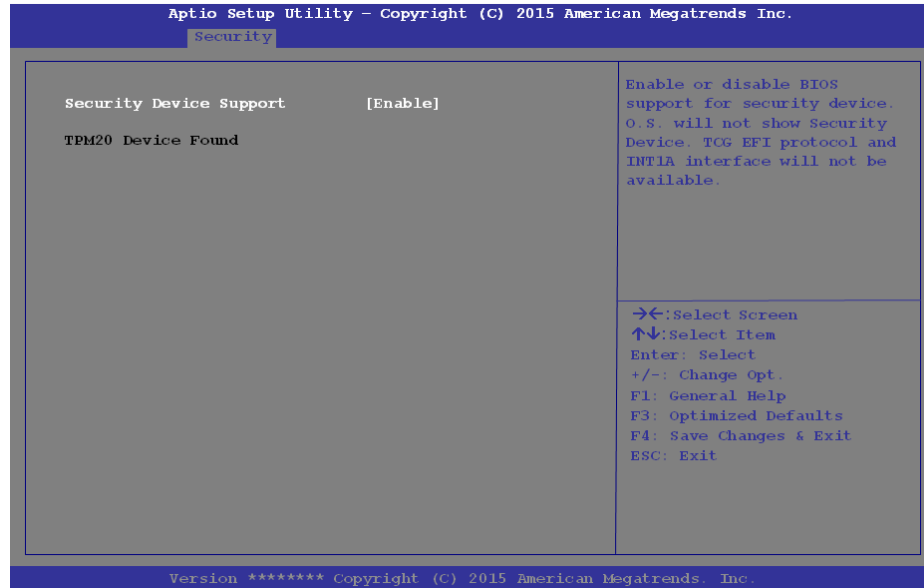

Figure 6 - 21
Security Device Support (Enabled)

TPM Management in Windows

You can manage your TPM settings from within *Windows*:

1. Go to the **Control Panel**.
2. Click **BitLocker Drive Encryption (System and Security)**.
3. Click **TPM Administration**.

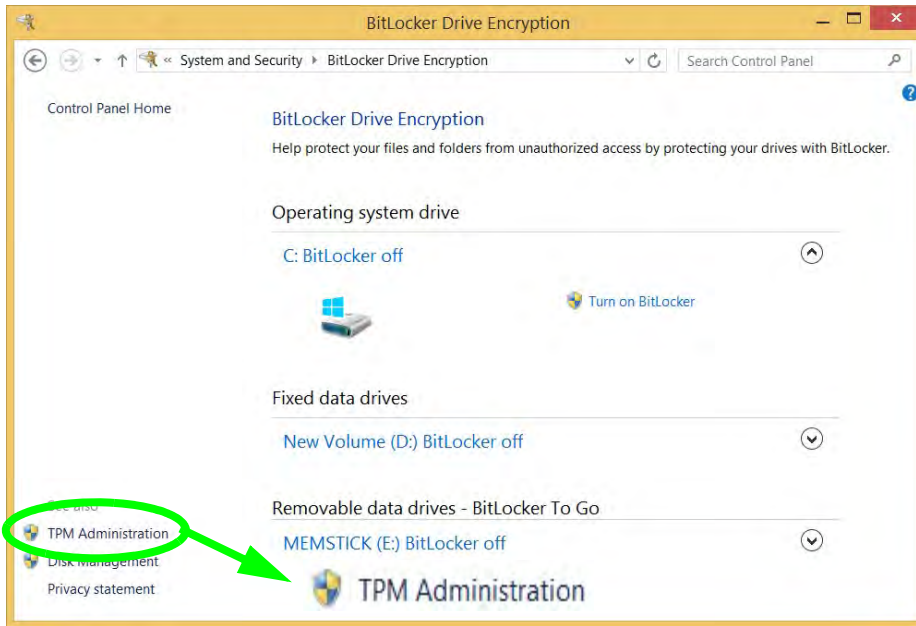
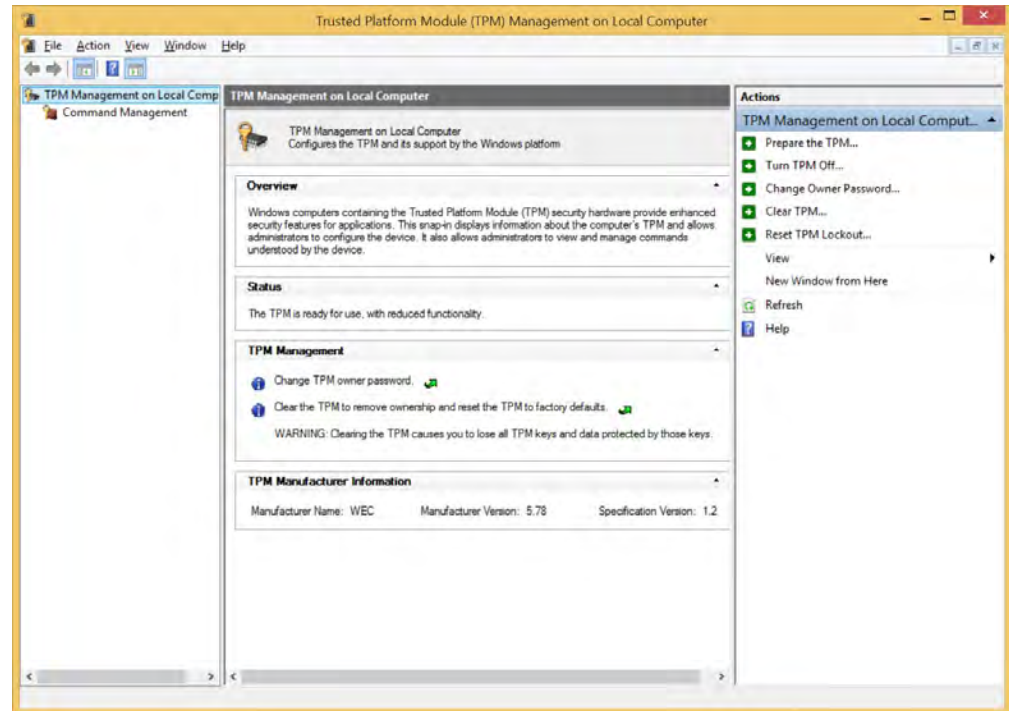

Figure 6 - 22
BitLocker Drive Encryption (TPM Administration)

Modules & Options

- The TPM Management window allows you to configure the TPM within **Windows**. As TPM is usually administered within large enterprises and organizations, your system administrator will need to assist you in managing the information here.



6

Figure 6 - 23
**Trusted Platform
Module (TPM)
Management on
Local Computer
Administration**

TPM Actions

1. Click **Prepare the TPM** and follow the instructions in the Wizard **to** prepare the TPM (this will probably require a restart of the computer and confirmation of the setting changes after restart by pressing the appropriate F key).
2. After the restart the TPM will be prepared and you can then use the **Actions** menu to **Turn TPM off**, **Change Owner Password**, **Clear TPM** or **Reset TPM Lockout**.
3. A wizard will help take you through any setup steps.

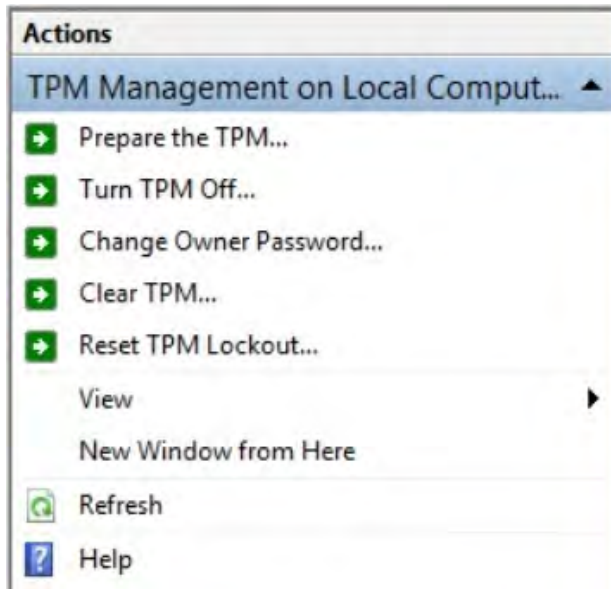

Figure 6 - 24
TPM Actions Menu

BitLocker

BitLocker Drive Encryption can be used in conjunction with the TPM to encrypt data on the disk. Access the Microsoft **BitLocker Drive Encryption** control panel applet from the *Windows* control panel (**System and Security**).

1. Click **Turn on Bit Locker**.
2. Follow the on-screen instructions to setup BitLocker, and make sure you have a removable media (e.g. a USB flash drive) to store saved recovery keys etc.

Figure 6 - 25
BitLocker Drive Encryption

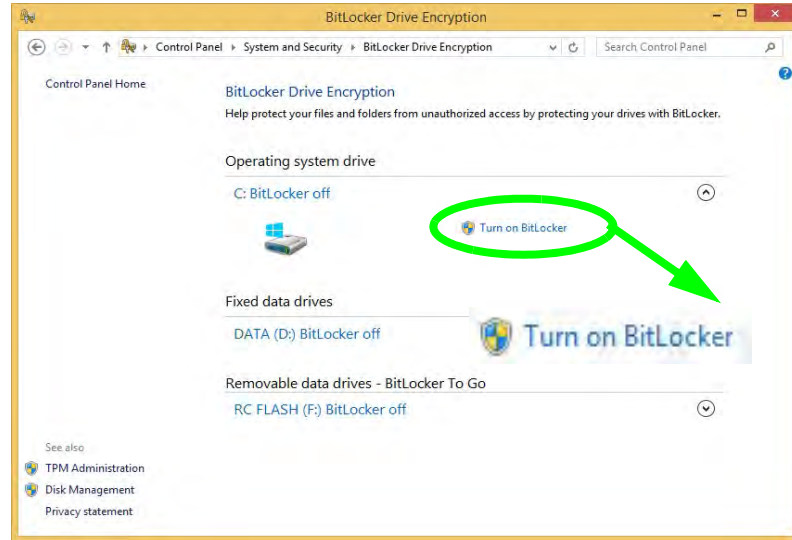

Wireless Display

Wireless Display uses your Wireless LAN module/WLAN Bluetooth Combo module (you need to make sure that your video adapter/display device is compatible with your particular WLAN/Combo module) in conjunction with a **compatible video adapter/display device** (purchased separately) to allow you to display the contents of the notebook display on another display (e.g. HDTV), without the need to have cables stretching across a room.

You can use the wireless display to play games, browse the internet, display videos or photo slide shows on your TV/external display without using HDMI or A/V cables.

Before configuring **Wireless Display** you will need to set up your **compatible adapter** with your display/speakers. Connect the adapter using an HDMI or A/V cable and turn on the display (or in the case of speakers connect them to the wireless speaker adapter with the cables provided with the adapter), and then set the display to the appropriate input channel (see the documentation supplied with your **compatible adapter/display** for full details).

Note that no driver or application is required for wireless display in **Windows 8.1**.



Compatible Adapters

For a list of compatible adapters check the video adapter/display device documentation, or with your distributor/supplier.

Wireless Display Configuration

1. Note that no driver or application is required for wireless display in **Windows 8.1**.
2. Go the **Charms Bar**, select **Devices**.
3. Click **Project**.
4. Click **Add a wireless display**.

Figure 6 - 26
Add a Wireless Display

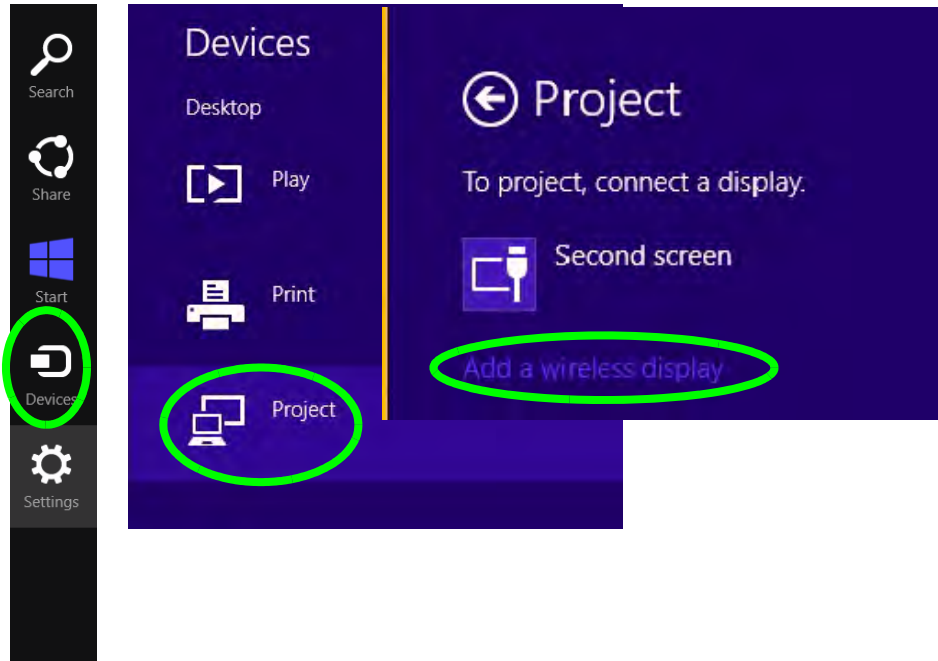

- The system will then search for compatible display devices (**this may take up to 60 seconds** so allow time for this to complete).

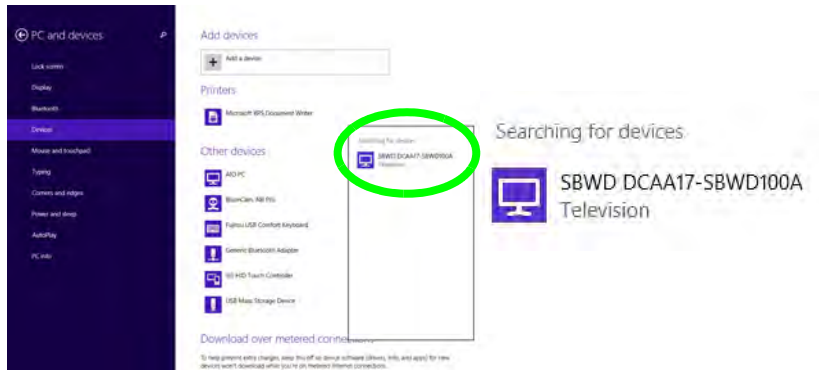

Figure 6 - 27
Searching For Devices

- Double-click any detected display device in the list.
- You may then need to input a pin number for the device to which you are connecting.
- Click **Next**.

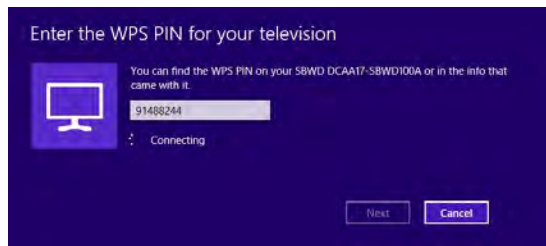
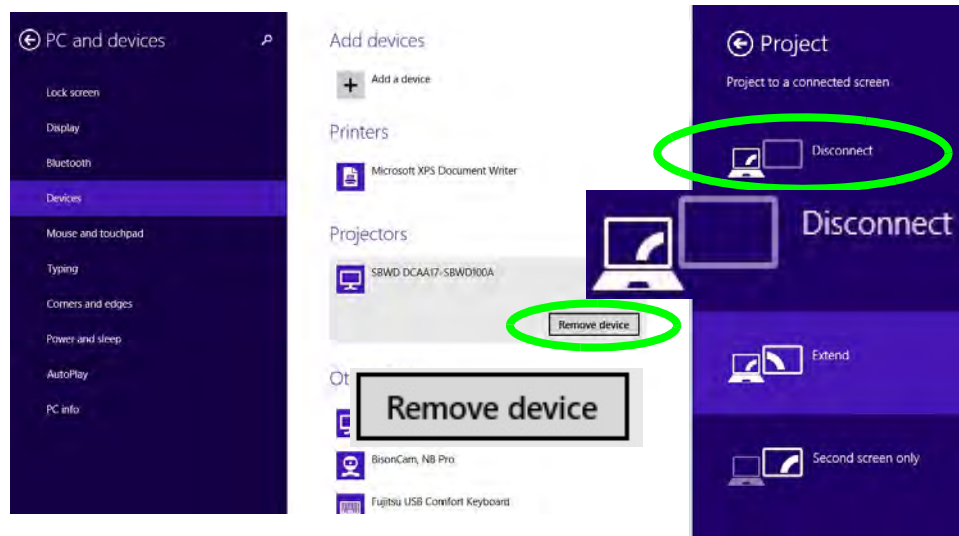

Figure 6 - 28
Enter PIN

Modules & Options

- The display will then connect (for specific settings for your display see the documentation supplied with your compatible adapter/display for full details).
- To disconnect from the display you can select it in **PC and Devices > Devices** and click **Remove Device > Yes**; or go to the **Project** menu (Charms Bar > Devices) and click **Disconnect**.

Figure 6 - 29
**Remove Device/
Disconnect**



Chapter 7: Troubleshooting

Overview

Should you have any problems with your computer, before consulting your service representative, you may want to try to solve the problem yourself. This chapter lists some common problems and their possible solutions. This can't anticipate every problem, but you should check here before you panic. If you don't find the answer in these pages, make sure you have followed the instructions carefully and observed the safety precautions in the preface. If all else fails, talk to your service representative. You should also make a record of what happened and what remedies you tried.

Of course, if something goes wrong, it will happen at the most inconvenient time possible, so you should preview this section just in case. If, after you've tried everything, and the system still won't cooperate, try turning it off for a few minutes and then rebooting. You will lose any unsaved data, but it may start working again. Then call your service representative.

Basic Hints and Tips

Many of the following may seem obvious but they are often the solution to a problem when your computer appears not to be working.

- **Power** - Is the computer actually plugged into a working electrical outlet? If plugged into a **power strip**, make sure it is actually working. Check the **LED Power & Communication Indicators** (see *“LCD Panel Open - Model A” on page 1 - 7* & *“LCD Panel Open - Model B” on page 1 - 8*) to see the computer’s power status.
- **Connections** - Check all the **cables** to make sure that there are no **loose connections** anywhere.
- **Power Savings** - Make sure that the system is not in **Hibernate** or **Sleep** mode by pressing the keys configured in your *Power Options* (see *“Power-Saving States” on page 3 - 7*), the **Fn + F12** key combination, or power button to wake-up the system.
- **Brightness** - Check the brightness of the screen by pressing the **Fn + F8 and F9** keys to adjust the brightness.
- **Display Choice** - Press **Fn + F7** to make sure the system is not set to “external only” display.
- **Boot Drive** - Make sure there are no **optical media and/or USB storage devices** in any connected drive.

Backup and General Maintenance

- Always **backup** your important data, and keep copies of your OS and programs safe, but close to hand. Don't forget to note the **serial numbers** if you are storing them out of their original cases, e.g. in a CD wallet.
- Run **maintenance programs** on your hard disk and OS as often as you can. You may schedule these programs to run at times when you are not using your computer. You can use those that are provided free with your OS, or buy the more powerful dedicated programs to do so.
- Write down your passwords and keep them safe (away from your computer). This is especially important if you choose to use a **Supervisor** password for the BIOS (see *“The Setup Utility” on page 5 - 2*).
- Keep copies of vital **settings files** such as network, dialup settings, mail settings etc.(even if just brief notes).



Warranty

The CPU is not a user serviceable part. Opening this compartment, or accessing the CPU in any way, may violate your warranty.

Viruses

- Install an **Anti-Virus** program and keep the **definitions file** (the file which tells your program which viruses to look for) up to date. New computer viruses are discovered daily, and some of them may seriously harm your computer and cause you to lose data. **Anti-Virus** programs are commercially available and the **definitions file updates** are usually downloadable directly from the internet.
- Be careful when opening e-mail from sources you don't know. **Viruses** are often triggered from within **e-mail attachments** so take care when opening any attached file. You can configure most **Anti-Virus** programs to check all **e-mail attachments**. **Note:** You should also beware of files from people you know as the virus may have infected an **address book** and been automatically forwarded without the person's knowledge.
- Keep a "**Bootable CD-ROM/DVD-ROM/USB storage device**" (this CD/DVD/USB device provides basic information which allows you to startup your computer) handy. You may refer to your OS's documentation for instructions on how to make one, and many **Anti-Virus** programs will also provide such a disk (or at least instructions on how to make one).

Upgrading and Adding New Hardware/Software

- Do not be tempted to make changes to your **Windows Registry** unless you are very sure of what you are doing, otherwise you will risk severely damaging your system.
- Don't open your computer or undertake any repair or upgrade work if you are not comfortable with what you are doing.
- Read the **documentation**. We can assume, since you are reading this that you are looking at the computer's manual, but what about any new peripheral devices you have just purchased? Many problems are caused by the installation of new hardware and/or software. Always refer to the documentation of any new hardware and/or software, and pay particular attention to files entitled "**READ ME**" or "**READ ME FIRST**".
- When installing a new device always make sure the device is powered on, and in many cases you will need to restart the computer. Always check that all the cables are correctly connected.
- Make sure you have installed the **drivers** for any new hardware you have installed (latest **driver files** are usually available to download from vendor's websites).

Troubleshooting



- Thoroughly check any **recent changes** you made to your system as these changes may affect one or more system components, or software programs. If possible, go back and undo the change you just made and see if the problem still occurs.
- Don't over complicate things. The less you have to deal with then the easier the source of the problem may be found; **Example** - if your computer has many devices plugged into its ports, and a number of programs running, then it will be difficult to determine the cause of a problem. Try disconnecting all of the devices and restarting the computer with all the peripheral devices unplugged. A process of elimination (adding and removing devices and restarting where necessary) will often find the source of a problem, although this may be time consuming.

Problems and Possible Solutions

Problem	Possible Cause - Solution
<p>You turned on the power but it doesn't work.</p>	<p><i>Battery missing / incorrectly installed.</i> Check the battery bay, make sure the battery is present and seated properly (the design of the battery only allows it to go in one way). Make sure there's nothing interfering with the battery contacts.</p>
<p>The battery LED power indicator , is blinking orange.</p>	<p><i>Low Battery.</i> Plug in the DC power source. If the computer doesn't start up immediately, turn it off then on again.</p>
<p>You are losing battery power too quickly.</p>	<p><i>The system is using too much power.</i> If your OS has a <i>Power Options</i> scheme (see "Power Plans" on page 3 - 5) check its settings. You may also be using a <i>peripheral device/USB device</i> that is drawing a lot of power.</p>
<p>Actual battery operating time is shorter than expected.</p>	<p><i>The battery has not been fully discharged before being recharged.</i> Make sure the battery is fully discharged and recharge it completely before reusing (see pages 3 - 14 to 3 - 21).</p> <p><i>Power Options have been disabled.</i> Go to the Control Panel in <i>Windows</i> and re-enable the options.</p> <p><i>A peripheral device/USB device is consuming a lot of power.</i> Turn off/remove the unused device to save power.</p>

Troubleshooting

Problem	Possible Cause - Solution
The computer feels too hot .	<p>Make sure the computer is properly ventilated and the Vent/Fan intakes are not blocked. If this doesn't cool it down, put the system into Hibernate mode or turn it off for an hour. Make sure the computer isn't sitting on a thermal surface (see "Overheating" on page 1 - 23). Make sure you're using the correct adapter.</p> <p>Make sure that your notebook is completely powered off before putting it into a travel bag (or any such container). Putting a notebook which is powered on in a travel bag may cause the Vent/Fan intakes to be blocked.</p>
Nothing appears on screen.	<p><i>The system is in a power saving mode.</i> Toggle the sleep/resume key combination, Fn + F4 (see "Configuring the Power Buttons" on page 3 - 9).</p> <p><i>The screen controls need to be adjusted.</i> Toggle the screen control key combinations Fn + F8/F9. If you're connected to an external monitor, make sure it's plugged in and turned on. You should also check the monitor's own brightness and contrast controls.</p> <p><i>The computer is set for a different display.</i> Toggle the screen display key combination, Fn + F7. If an external monitor is connected, turn it on.</p> <p><i>The screen saver is activated.</i> Press any key or touch the TouchPad.</p>
No image appears on the external monitor I have plugged in and powered on.	<p><i>You haven't installed the video driver and configured it appropriately from the Control Panel.</i> See Appendix C for instructions on installing and configuring the video driver.</p>

Problem	Possible Cause - Solution
You forget the boot password .	<i>If you forget the password, you may have to discharge the battery of the CMOS. Contact your service representative for help.</i>
<div style="text-align: center;">  <p>Password Warning</p> <p>If you choose to set a boot password, NEVER forget your password. The consequences of this could be serious. If you cannot remember your boot password you must contact your vendor and you may lose all of the information on your hard disk.</p> </div>	
The sound cannot be heard or the volume is very low .	<i>The volume might be set too low. Check the volume control in the Volume Control Panel in the Windows notification area, or use the key combination Fn + F5 and F6 (see “Function/Hot Key Indicators” on page 1 - 14) to adjust.</i>
My internal microphone seems to be disabled and/or I can still hear sound from the speakers even though I have plugged headphones into the headphone jack.	<i>You have disabled “Front panel jack detection” in Connector Settings in the Realtek HD Audio Manager control panel. Go to the Realtek HD Audio Manager and click the Connector Settings icon  and make sure that there is no tick alongside “Front panel jack detection” and click OK.</i>
The CD/DVD cannot be read .	<i>The CD/DVD is dirty. Clean it with a CD/DVD cleaner kit.</i>
The CD/DVD tray will not open when there is a disc in the tray.	<i>The CD/DVD is not correctly placed in the tray. Gently try to remove the disc using the eject hole (see “Loading Discs” on page 2 - 3).</i>

Troubleshooting

Problem	Possible Cause - Solution
The DVD regional codes can no longer be changed.	<i>The code has been changed the maximum 5 times. See “DVD Regional Codes” on page 2 - 5.</i>
Unwelcome numbers appear when typing.	<i>Num Lock is turned ON (see “Function/Hot Key Indicators” on page 1 - 14).</i>
I am sliding my finger up and down on the right side of the Touchpad to scroll a Window and the Touchpad does not respond .	<i>There are different Touchpad versions available on this computer, and this version requires tapping/holding to scroll. Either tap repeatedly, or hold the finger down, at the top or bottom right of the Touchpad (depending on the scrolling direction required) to scroll the window.</i>
 <h3>Other Keyboards</h3> <p>If your keyboard is damaged or you just want to make a change, you can use any standard USB keyboard. The system will detect and enable it automatically. However special functions/hot keys unique to the system's regular keyboard may not work.</p>	
The system freezes or the screen goes dark.	<i>The system's power saving features have timed-out. Use the AC/DC adapter, press the sleep (Fn + F4) key combination, or press the power button if no LEDs are lit.</i>

Problem	Possible Cause - Solution
The system never goes into a power saving mode .	Power Options features are not enabled. Go to the Windows Power Options menu and enable the features you prefer (see “Power-Saving States” on page 3 - 7). Make sure you have enabled Hibernate mode from the control panel.
The Wireless LAN/Bluetooth modules cannot be detected.	<i>The modules are off as the computer is in Airplane Mode.</i> Go to the Charms Bar and select Settings and then click the WiFi icon (Airplane mode should be Off).
The PC Camera module cannot be detected.	<i>The module is off.</i> Press the Fn + F10 key combination in order to enable the module (see “Function/Hot Key Indicators” on page 1 - 14). Run the camera application to view the camera picture.
The Wireless LAN/Bluetooth modules cannot be configured.	The driver(s) for the module(s) have not been installed. Make sure you have installed the driver for the appropriate module (see the instructions for the appropriate module in “Modules & Options” on page 6 - 1).
A file cannot be copied to/from a connected Bluetooth device.	<i>The transfer of data between the computer and a Bluetooth enabled device is supported in one direction only (simultaneous data transfer is not supported).</i> If you are copying a file from your computer to a Bluetooth enabled device, you will not be able to copy a file from the Bluetooth enabled device to your computer until the file transfer process has been completed

Troubleshooting

Problem	Possible Cause - Solution
I cannot obtain high speed Bluetooth data transfer.	<p data-bbox="612 225 1422 253"><i>To obtain high speed Bluetooth data transfer take into account the following:</i></p> <ul data-bbox="612 266 1458 426" style="list-style-type: none"><li data-bbox="612 266 1458 362">• To achieve high speed transfer speeds, both devices must support high speed data transfer (i.e both the computer and the Bluetooth compatible device you are connecting to).<li data-bbox="612 367 1458 426">• Check your Bluetooth compatible device's documentation to confirm it supports high speed data transfer, and for configuration information.

Problem	Possible Cause - Solution
<p>I have used Update Driver in Device Manager (Unknown device > Other Devices) to try and install the Airplane Mode driver. Windows encountered a problem in attempting to update the driver, and a yellow exclamation mark appears in Device Manager against the Unknown device.</p>	<p><i>It is very important that the drivers are installed in the order indicated in Chapter 4 (which is the numbered installation order on the Device Drivers & Utilities + User's Manual disc). This issue can occur when drivers are manually installed, and not in the correct order.</i></p> <p>If you have attempted to Update Driver from the Device Manager control panel and have encountered problems, then use the method below to correct this:</p> <p>To correct this problem:</p> <ol style="list-style-type: none"> 1. Go to the Programs and Features (Programs) control panel in Windows. 2. Select any installed Airplane Mode driver item (e.g. Insyde Airplane Mode HID Mini-Driver), and click Uninstall/Change to uninstall the current driver. 3. Restart the computer. 4. Insert the <i>Device Drivers & Utilities + User's Manual disc</i> and click Install Drivers (button). 5. Double-click the Airplane Driver item in the menu. 6. Follow the instructions to install the correct driver (you will need to restart the computer as part of the installation process).

Troubleshooting

Problem	Possible Cause - Solution
When using a Bluetooth headset the audio appears to be mono and not stereo.	<p><i>This is a common issue with Bluetooth headsets. To resolve this issue do the following (you will need to repeat this procedure after every boot up, restart, or when the system resumes from hibernation):</i></p> <ol style="list-style-type: none">1. Go to the Devices & Printers control panel in Windows.2. Double-click the Bluetooth headset.3. Click Connect to complete the stereo connection. <p>OR</p> <ol style="list-style-type: none">1. Go to the Sound control panel in Windows.2. Right-click (in the Playback tab) the Bluetooth Stereo Audio device (the default device is Headset).3. Click Connect to complete the stereo connection.

3G/4G Module PIN Code & Power-Saving

Note that there may be some issues when a PIN Code is set for a 3G/4G module (if you are unsure of your module version contact your distributor/supplier) in *Windows*, if Mobile Broadband has been turned off, and the system has resumed from a power-saving state. **To prevent any issues it is recommended that you simply do not enable a PIN for a 3G/4G module.** The following provides instructions for disabling the PIN code.

Disabling a PIN code for a 3G/4G Module

1. Go to the **Charms Bar**.
2. Click **Change PC Settings**.

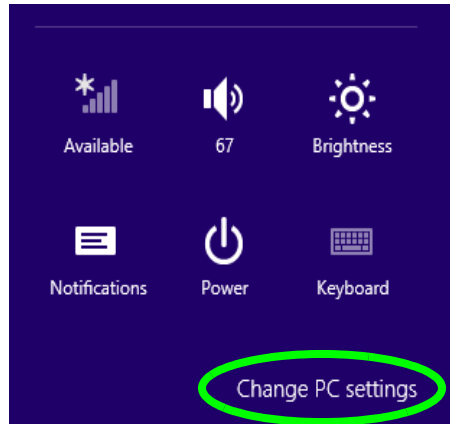

Figure 7 - 1 - Change PC Settings

Troubleshooting

3. Click **Network**.
4. Click the broadband connection under **Mobile Broadband**.
5. Scroll down to **Security** and click **Remove PIN**.
6. Enter the current PIN number and click **OK**.
7. **It is recommended that you do not Enable a PIN for a 3G/4G module.**

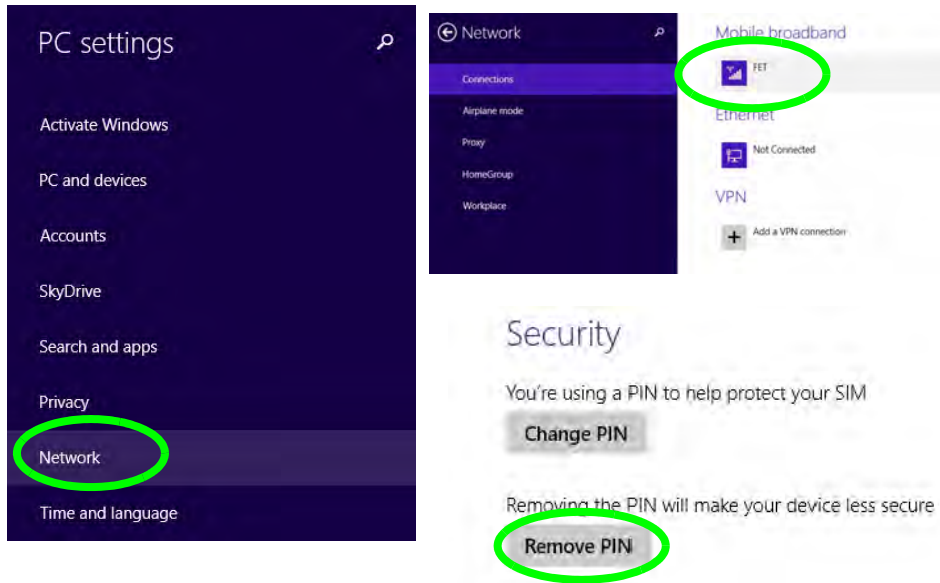

Figure 7 - 2 - Disable PIN

Resolving the “Insert a SIM” issue with the 3G/4G Module (Windows 8.1)





1. If a PIN was set for the 3G/4G module, you have then switched **Mobile broadband off** (or put the system in **Airplane Mode**) in **Networks**, and the system has just resumed from a power-saving state the following error may occur.
2. On resuming from the power-saving state the standard procedure would be to go to **Networks** in the **Charms Bar** and turn on Mobile broadband.
3. Go to the **Charms Bar**.
4. Select **Settings** and you will then note that the **WiFi icon** will read **Unavailable**.
5. Standard procedure would be to click the connection and enter the PIN number to unlock the connection.
6. In this instance you will note that the **Mobile broadband** connection will read **Insert a SIM**.
7. In this case you will need to **restart the computer**.
8. After system restart you can then connect to the Mobile Broadband as normal.
9. **To fully resolve this issue it is recommended that you do not Enable a PIN a 3G/4G module.**

Appendix A: Interface (Ports & Jacks)







Overview

The following chapter will give a quick description of the interface (ports & jacks) which allow your computer to communicate with external devices, connect to the internet etc.

Notebook Ports and Jacks

Item	Description
<p>Card Reader</p> 	<p>The card reader allows you to use some of the latest digital storage cards. Push the card into the slot and it will appear as a removable device.</p> <p>For All Models:</p> <ul style="list-style-type: none"> • MMC (MultiMedia Card) / RSMMC • SD (Secure Digital) / Mini SD / SDHC / SDXC <p>For Models A & B Only:</p> <ul style="list-style-type: none"> • MS (Memory Stick) / MS Pro / MS Duo
<p>DC-In Jack</p> 	<p>Plug the supplied AC/DC adapter into this jack to power your computer.</p>
<p>External Monitor (VGA) Port</p> 	<p>This port allows you to connect an external monitor, or Flat Panel Display, to get dual video or simultaneous display on the LCD and external monitor/FPD.</p>
<p>HDMI-Out Port</p> 	<p>The HDMI-Out (High-Definition Multimedia Interface) is an audio/video connector interface for transmitting uncompressed digital streams. This allows you to connect an external monitor, TV or Flat Panel Display etc. as a display device by means of a HDMI cable. Note that HDMI carries both audio and video signals.</p>

Interface (Ports & Jacks)

Item	Description
Headphone-Out Jack 	Headphones or speakers may be connected through this jack. Note: Set your system's volume to a reduced level before connecting to this jack.
Microphone-In Jack 	Plug an external microphone in to this jack to record on your computer.
RJ-45 LAN Jack 	This port supports LAN (Network) functions. Note: Broadband (e.g. ADSL) modems usually connect to the LAN port.
Security Lock Slot 	To prevent possible theft, a Kensington-type lock can be attached to this slot. Locks can be purchased at any computer store.
USB 2.0/1.1 Port  USB 3.0 Port 	USB 2.0 compatible ports (USB 2.0 is fully USB 1.1 compliant) are for low-speed peripherals such as keyboards, mice or scanners, and for high-speed peripherals such as external HDDs, digital video cameras or high-speed scanners etc. Devices can be plugged into the computer, and unplugged from the computer, without the need to turn the system off (if the power rating of your USB device is 500mA or above, make sure you use the power supply which comes with the device). The USB 3.0 ports are denoted by their blue color; and USB 2.0 ports are colored black. USB 3.0 will transfer data much faster than USB 2.0, and is backwards-compatible with USB 2.0. Note that Model A computers have one USB 2.0 port, but Model B & C computers have two USB 2.0 ports.

A

Interface (Ports & Jacks)

A

Appendix B: Control Center

Overview

The following chapter will give a quick description of the functions of the **Control Center**. The **Control Center** gives quick access to frequently used controls, power management features and enables you to quickly turn modules on/off. Click the **Control Center** icons to toggle the appropriate function, or hold the mouse button down and move the dial control where applicable. Certain functions will automatically be adjusted when a power mode is selected. The **Control Center** in *Windows 8.1* works under the **Desktop** App and not under the Start screen.



Control Center Access

To run the Control Center press the **Fn + Esc** key combination or double-click the icon  in the notification area of the taskbar.

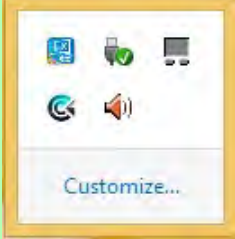

Close the Control Center by clicking the  close icon in the top right of the panel (move the cursor onto the top right corner of the panel to highlight it).

Figure B - 1 - Control Center

Control Center

Power Modes

You can set a **Power Mode** by clicking the appropriate icon at the top of the **Control Center**. Each power mode will affect the Power Conservation Mode, Airplane Mode, Power Plan and PC camera power etc.

You can click a **Control Center** icon to set an overall power mode and then click individual icons in the **Control Center** to power on/off the Touchpad and PC camera.







Modes		Quiet	Power Saving	Performance	Entertainment	Note
Icon						Quiet Mode will set the Fan Speed to Silent . When Fan Speed is set to Silent the System Power Plan will be set to Power Saver and the Power Conservation Mode will be set to Energy Star .
Power Plan		Balanced	Power Saver	High Performance	Balanced	
Power Conservation Mode		Balance	Energy Star	Performance	Balance	
PC Camera		ON	OFF	ON	ON	
TouchPad		ON	ON	ON	ON	
Airplane Mode		OFF	ON	OFF	OFF	

Table B - 1- Power Modes

Control Center Menus

The Control Center contains 2 menu headings (**System Program & Device**) under the Power Modes. Click the menu headings and then click any of the buttons outlined on the following pages.



Figure B - 2 - Control Center Menus

Power Status (System Program)



The **Power Status** icon will show whether you are currently powered by the battery, or by the AC/DC adapter plugged in to a working power outlet. The power status bar will show the current battery charge state.

Brightness (System Program)



The **Brightness** icon will show the current screen brightness level. You can use the slider to adjust the screen brightness or the **Fn + F8/F9** key combinations, or use the **Fn + F2** key combination to turn off the LED backlight (press any key to turn it on again).

Control Center

Volume (System Program)



The **Volume** icon will show the current volume level. You can use the slider to adjust the Volume or the **Fn + F5/F6** key combinations, or use the **Fn+ F3** key combination to mute the volume.

Fan Speed (System Program)



Note that this item will not appear if your CPU's power requirement is 4W (4 Watts) or less as no fan is required. You can set the fan speed to **Maximum (full power)**, **Automatic** or **Silent** (the system can override the **Silent** fan if required). The fan speed will adjust itself automatically to control the heat of the CPU. However you can adjust the setting to maximum for enhanced performance if you prefer.

Power Conservation (System Program)



This system supports **Energy Star** power management features that place computers (CPU, hard drive, etc.) into a low-power sleep modes after a designated period of inactivity (see *“Power Conservation Modes” on page 3 - 12*). Click either the **Performance**, **Balanced** or **Energy Star** button.

Sleep Button (System Program)



Click either the **Hibernate** or **Sleep** buttons to have the computer enter the selected power-saving mode when the **Fn + F4** key combination is pressed (see *“Power-Saving States” on page 3 - 7*).

Display Switch (System Program)

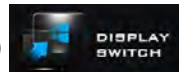

Click the **Display Switch** button to access the menu (or use the  + **P** key combination) and select the appropriate attached display mode.

Time Zone (System Program)

Clicking the **Time Zone** button will access the **Date and Time Windows** control panel.

Desktop Background (System Program)

Clicking the **Desktop Background** button will allow you to change the desktop background picture.

TouchPad/PC Camera (Device)

Click either of these buttons to toggle the TouchPad or camera module's power status. The icon will appear dimmed when it is disabled. Note that the power status of the camera module is also effected by the **Power Mode** selected (see [Table B - 1, on page B - 2](#)).

Caps Lock/Scroll Lock/Number Lock/Airplane Mode

Click the button to toggle the appropriate lock mode and Airplane Mode.



Appendix C: Video Driver Controls

The basic settings for configuring the LCD are outlined in “*Video Features*” on [page 1 - 37](#).

Intel Video Driver Installation

Make sure you install the drivers in the order indicated in [Table 4 - 1, on page 4 - 3](#).

1. Click **2.Install VGA Driver > Yes**.
2. Click **Next > Yes > Next > Next**.
3. Click **Finish** to restart the computer.

Note: After installing the video driver go to the **Display** control panel to adjust the video settings to the highest resolution.

Dynamic Video Memory Technology

Intel® DVMT automatically and dynamically allocates as much system memory (RAM) as needed to the integrated video system (**the video driver must be installed**). DVMT returns whatever memory is no longer needed to the operating system.



Video Card Options

Note that card types, specifications and drivers are subject to continual updates and changes. Check with your distributor/supplier for the latest details on video cards supported.

DVMT Notes

DVMT is not local video memory.

DVMT will not function in MS-DOS. DOS uses the legacy memory indicated.

Intel® HD Graphics Control Panel

Advanced video configuration options are provided by the **Intel® HD Control Panel**. To access the control panel see below and overleaf:

1. Click the **Intel® HD Graphics Control Panel** icon in the **Apps** screen.

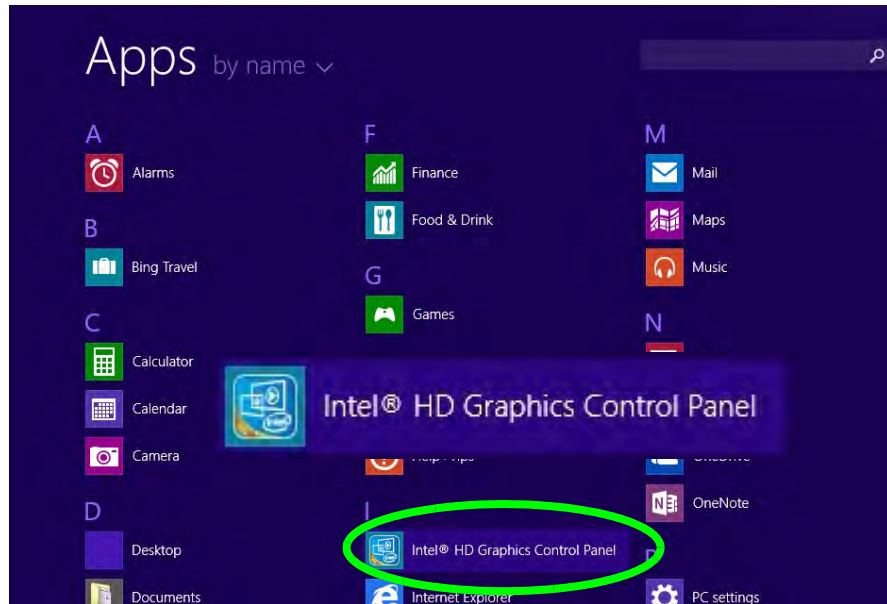

Figure C - 1
Apps Screen
Intel® HD Graphics
Control Panel

(see over)

OR

2. Right-click the **Desktop** and select **Graphics Properties** from the menu.

OR

3. Click **Advanced settings** in the **Screen Resolution** control panel in **Windows**.
4. Click the **Intel(R) HD Graphics Control Panel** tab and click **Graphics Properties** (button).
5. Double-click the **Intel(R) HD Graphics** control panel in the **Windows Control Panel**.

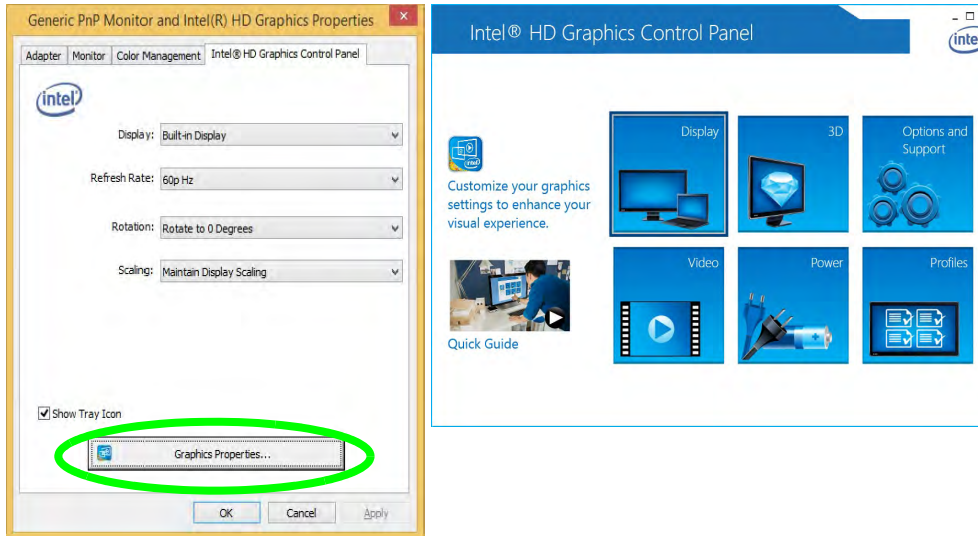

Figure C - 2
**Intel® HD Graphics
Control Panel**

Video Driver Controls



Quick Guide

If you have a working internet connection, you can click on the **Quick Guide** box to access on-line videos to help you configure the control panel to your preferences.

You may make changes to any of the graphics properties by clicking the appropriate menu panel and adjusting the settings from the menus.

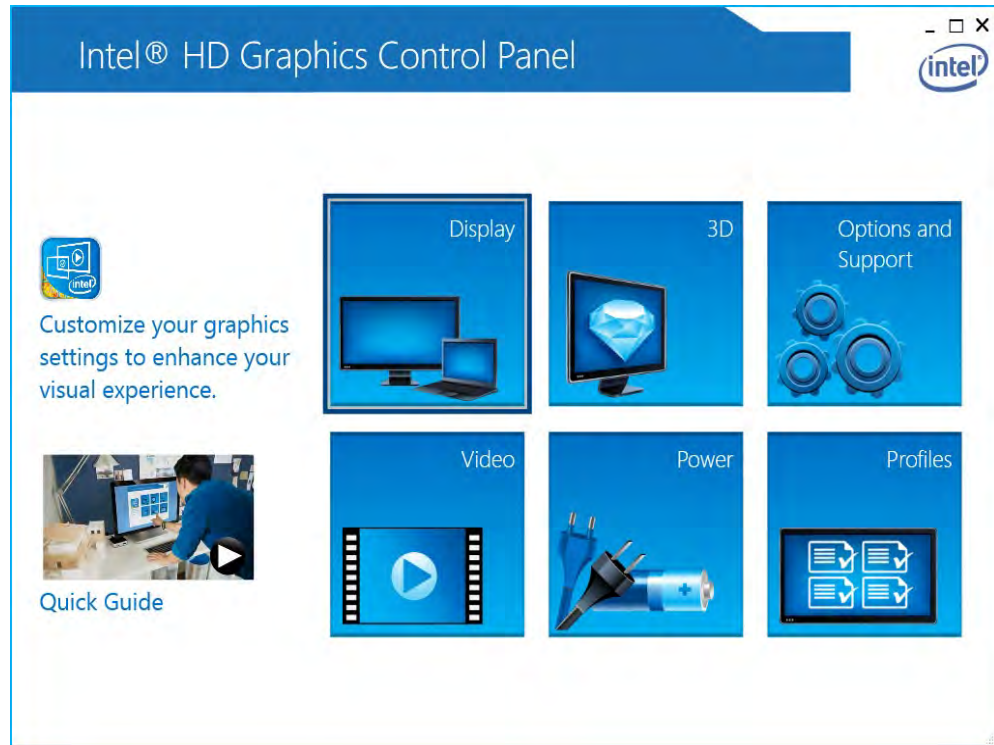

Figure C - 3

Intel® HD Graphics Control Panel

Sub-Menus

Some of the menu panels will also have sub-menus (in the top left corner of the menu alongside the icon ) to display further configuration options.



Figure C - 4
**Intel® HD Graphics
Control Panel
Sub-Menus**

Video Driver Controls



Multiple Display

At least one other display must be attached in order to view multiple display selection options.

Figure C - 5
Intel® HD Graphics Control Panel
Display Settings

Display

Click either **Display Settings** or **Color Settings** to make display adjustments, including configuration for any attached external displays.

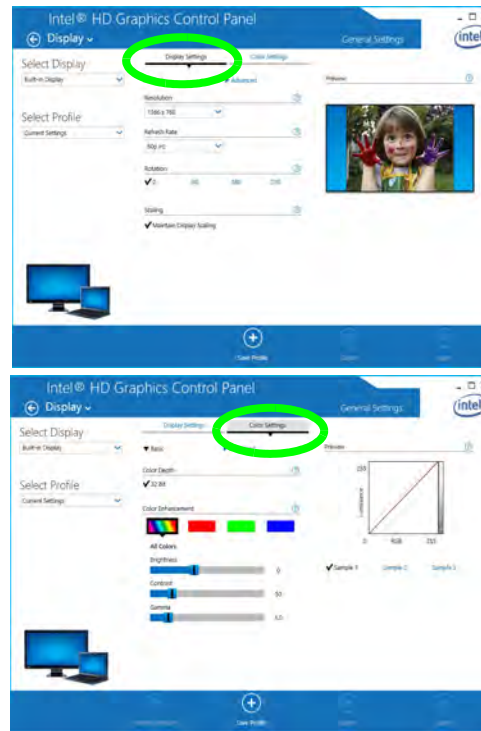

Click the **Display** menu at the top of the screen to display the sub-menus. The **Multiple Displays** menu allows you to configure the display mode of any attached displays (see “*Attaching Other Displays*” on page C - 17).



Multiple Display

At least one other display must be attached in order to view multiple display selection options.

Audio Settings

Any attached active displays must have audio capacity to allow audio configuration.

Figure C - 6
Intel® HD Graphics
Control Panel
Display Settings -
Multiple Displays

Video Driver Controls

The **Custom Resolutions** sub-menu allows you to adjust the display (or any attached display) to any width, height, refresh rate, color depth and underscan percentage of your choice. Note that incorrect settings can cause system instability and even possible component damage, so this is adjusted at your own risk.

Figure C - 7
**Intel® HD Graphics
Control Panel
Display Settings -
Custom
Resolutions**

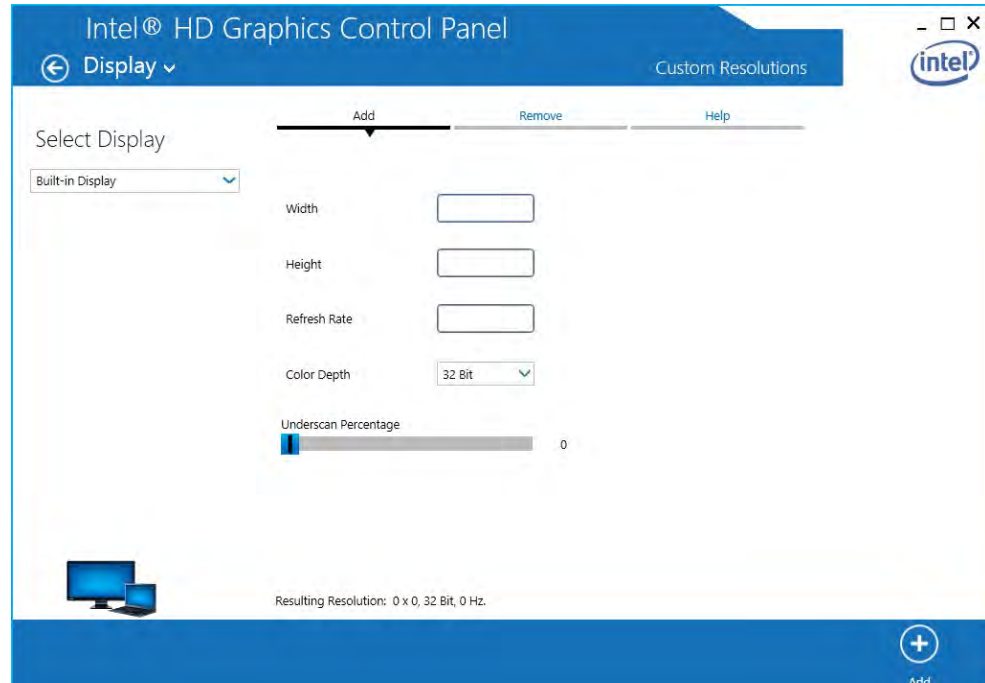

3D

This menu allows you to choose how 3D images are displayed. Performance **Quality** displays the most detail, **Balanced Mode** provides better computer performance with good quality and **Custom** allows you to configure the **Anisotropic Filtering** and **Vertical Sync** and features to your preferences. Click **Apply** to save changes.

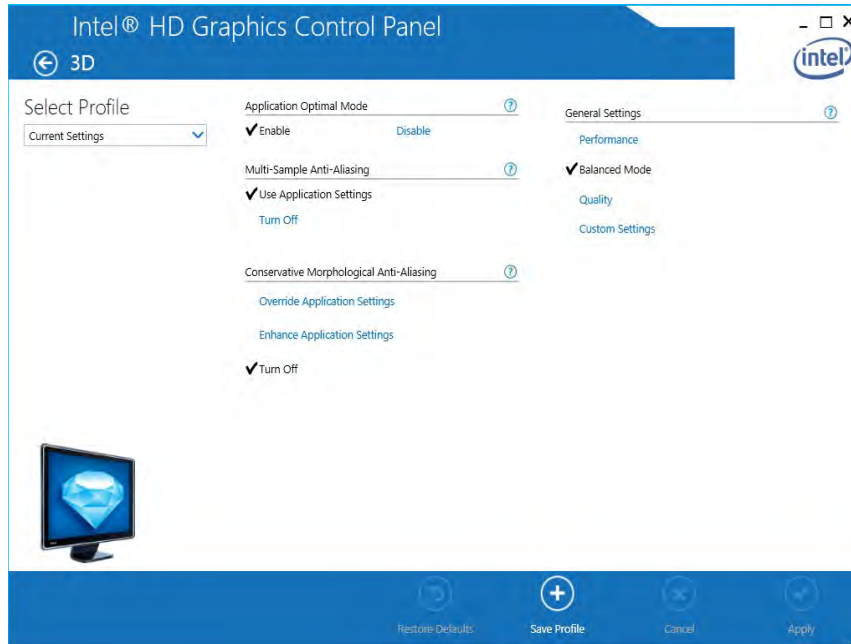

Figure C - 8
**Intel® HD Graphics
Control Panel 3D**

Options and Support

Hot Key Manager in **Options and Support** allows you to create hot keys for opening the application, rotating the display, scaling etc. Click **Apply** to save changes.



Figure C - 9
**Intel® HD Graphics
Control Panel
Options and
Support**

Click the **Options** menu at the top of the screen to display the sub-menus. The **Information Center** provides details on **System Information**, the **Built-In Display** and any **attached displays**.

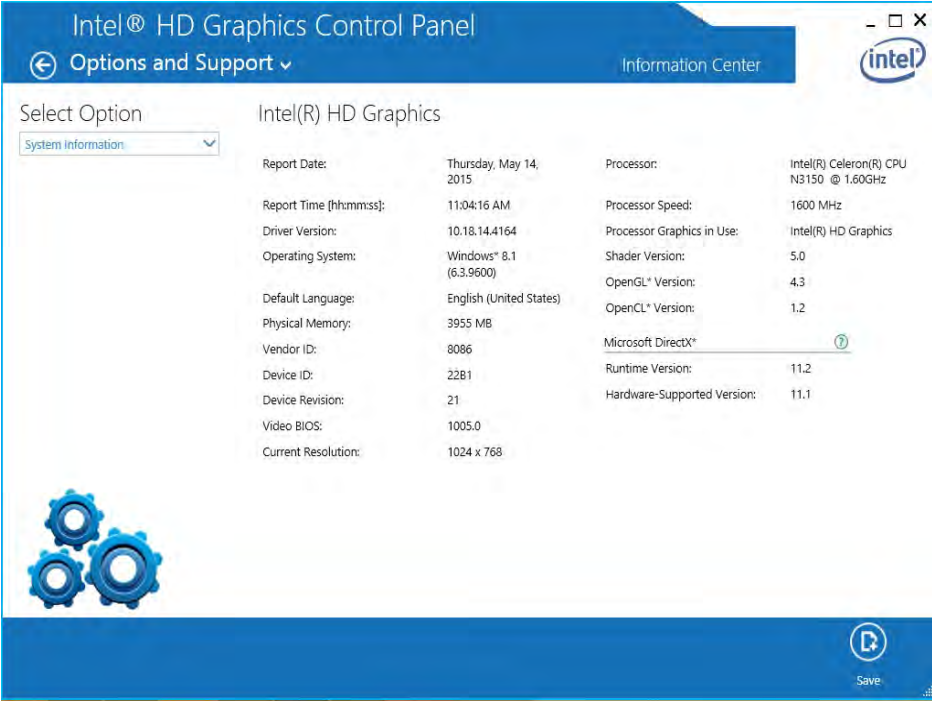



Preferences

Go to the **Preferences** sub-menu in Options to configure the preferences for the Intel® HD Graphics Control Panel.

Make sure you **Enable Tray Icon** to display the Intel® HD Graphics Control Panel icon in the notification area of the taskbar (as below).

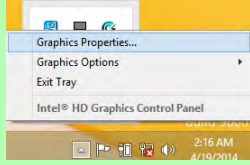

Figure C - 10 Intel® HD Graphics Control Panel Options - Information Center



Video Driver Controls

Video

The **Video Profiles** menu allows you to brighten or darken movies, or to switch to vivid colors. The **Preview** image will display a sample image using the current settings. You can **Save Profile** and name the Profile to recall the settings at any time. Click **Apply** to save changes (select **Color Enhancement**, **Image Enhancement**, **Image Scaling** or **Gamut Mapping** from the menu).

Figure C - 11
**Intel® HD Graphics
Control Panel -
Video
(Color
Enhancement)**

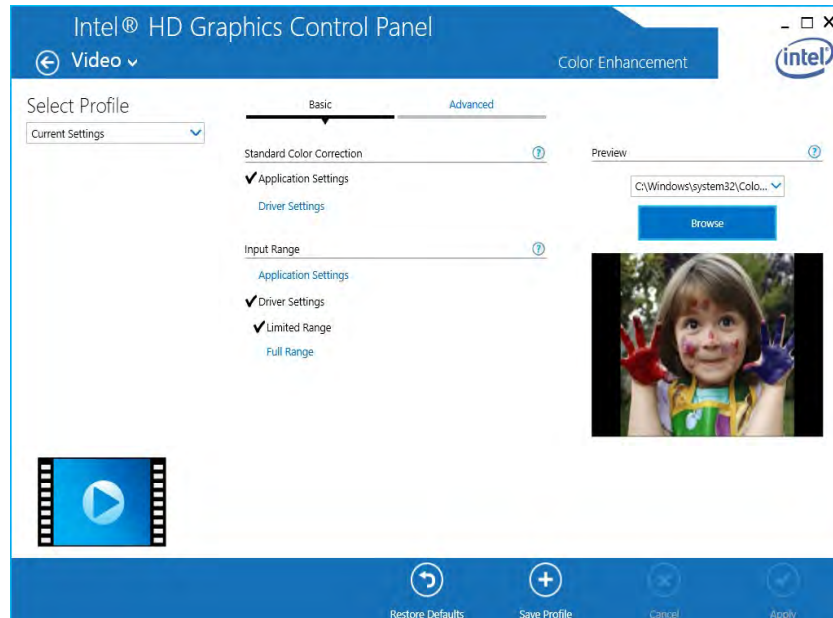

Click the **Video** menu at the top of the screen to display the sub-menus. The **Image Enhancement** menu allows you to adjust the **Sharpness**, **Skin Tone Enhancement**, **Noise Reduction**, **Contrast Enhancement** and **Film Mode Detection** etc. Click **Apply** to save changes.

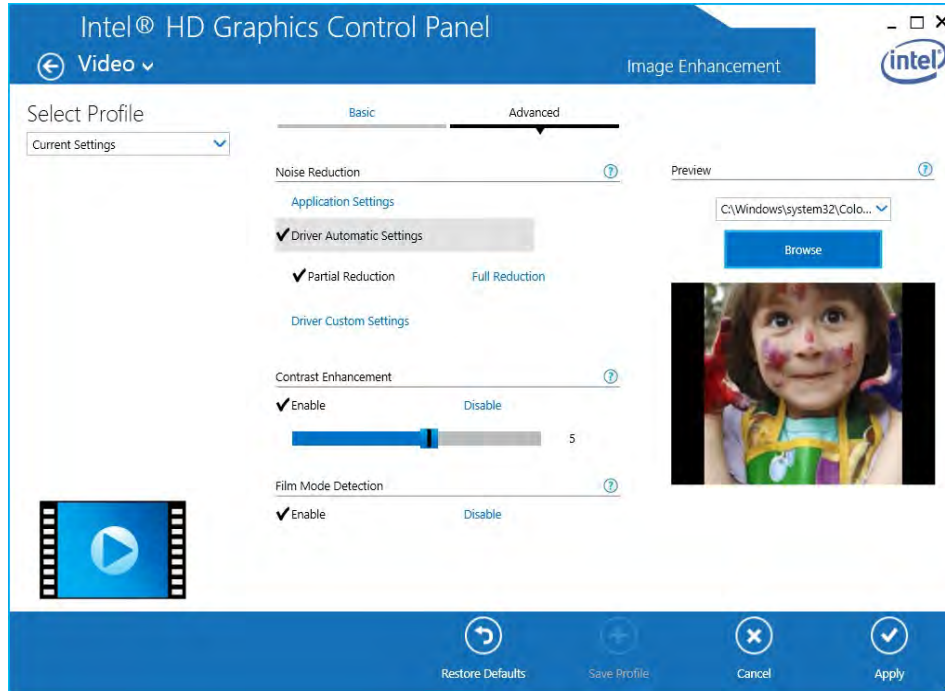
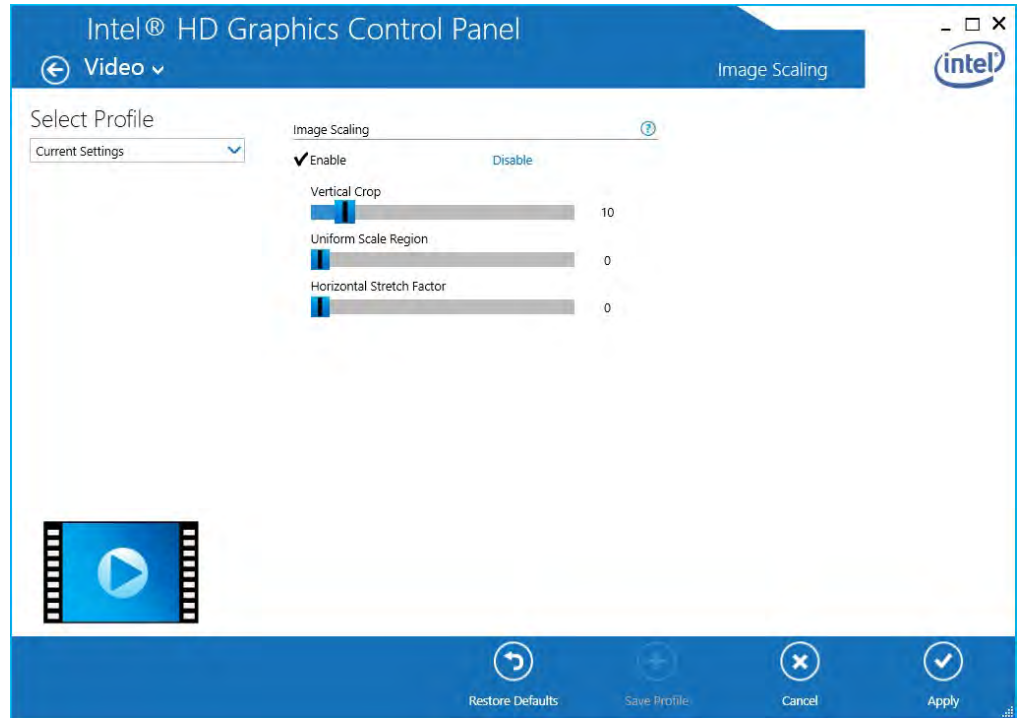

Figure C - 12
**Intel® HD Graphics
Control Panel - Video
(Image
Enhancement Basic)**

Video Driver Controls

Turn **Image Scaling** on, and use the sliders to adjust the scaling.

Figure C - 13
**Intel® HD Graphics
Control Panel Video
Image Scaling**



Power

There are two separate menus to adjust the power settings for whenever the computer is **Plugged In** or **On Battery**. **Maximum Battery Life** will reduce graphics performance for power saving, **Balanced** will provide full graphics performance when required and minimize power consumption when inactive, and **Maximum Performance** will give top graphics performance but requires more power.

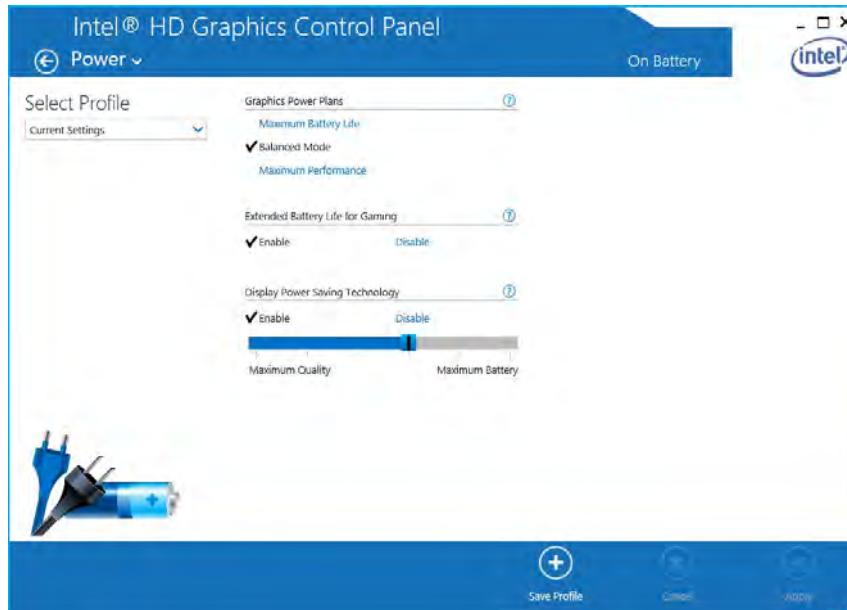

Figure C - 14
Intel® HD Graphics
Control Panel -
Power



4K2K Videos on 4K2K External Displays

Note you may experience some video lag when playing 4K2K videos on an attached 4K2K external display.

Table C - 1
Display Modes

Display Devices & Options

Note that you can use external displays connected to the HDMI-Out port and/or external monitor port. See your display device manual to see which formats are supported.



Attaching Displays

When you first attach an external display you may find that the desktop does not occupy the full screen area. Use either the display's auto adjust/configure controls, or the Intel(R) HD Graphics Control Panel to configure the full screen display.

Display Mode	Description
Single Display	One of the connected displays is used as the display device (PC screen only or Second screen only).
Clone/Duplicate	Both connected displays output the same view and may be configured independently
Extended / Extend	Both connected displays are treated as separate devices, and act as a virtual desktop

Attaching Other Displays

To Clone Displays:

1. Attach your external display to the HDMI-Out port/external monitor port, and turn it on.
2. Go to the **Intel(R) HD Graphics Control Panel** control panel and click **Display > Multiple Displays** (sub-menu).
3. Click **Clone** from the **Select Display Mode** menu.
4. Click **Apply**, and **OK** to confirm the settings change.
5. Select the displays from the **Select One or More Active Displays** menu.



Multiple Display

At least one other display must be attached in order to view **Multiple Display** selection options.

Figure C - 15
Display > Multiple Displays (Clone)

Video Driver Controls

Display Settings Extended Desktop

You can have different Colors, Screen Area and Monitor Refresh Rates for each display device **provided your monitor can support them.**

You can drag the monitor icons to match the physical layout of your displays. Icons and programs may also be dragged between the displays.

To Enable Extended Mode:

1. Attach your external display to the HDMI-Out port/external monitor port, and turn it on.
2. Go to the **Intel(R) HD Graphics Control Panel** control panel and click **Display > Multiple Displays** (sub-menu).
3. Click **Extended** from the **Select Display Mode** menu.
4. Click **Apply**, and **OK** to confirm the settings change.



Click the appropriate monitor icon and drag it to match the physical arrangement you wish to use (e.g. the secondary display may be extended left/right/above/below the primary display).

Figure C - 16

Display > Multiple Displays (Extended)

Attaching Other Displays - Devices (Charms Bar)

You can configure attached displays from **Devices** (in the **Charms Bar**).

1. Attach your external display to the HDMI-Out port/external monitor port, and turn it on.
2. Go the **Charms Bar**, select **Devices**.
3. Click **Project** (you may need to click **Second Screen**).
4. Click on any one of the options from the menu to select **PC screen only**, **Duplicate**, **Extend** or **Second screen only**.

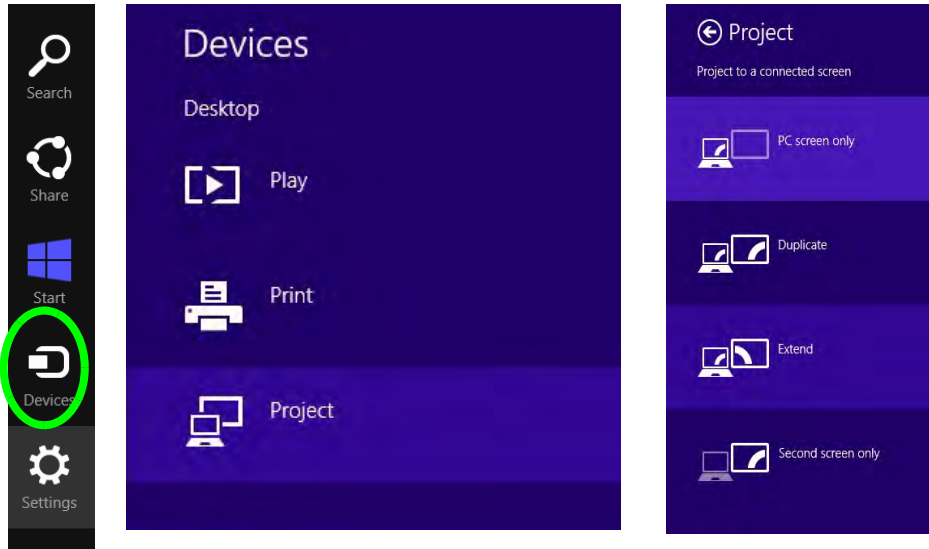

Windows Logo Key + P Key Combination

You can use the **Windows Logo Key + P** key combination to quickly bring up the **Second Screen** menu.

You can also use the **Display Switch** button in the **Control Center** to access the menu and select the appropriate attached display mode.

You can also use the **Fn + F7** key combination to quickly access the **Second Screen** menu in **Windows**.

Figure C - 17
Second Screen
(Devices)

Configuring an External Display In Windows

1. Attach your external display to the HDMI-Out port/external monitor port, and turn it on.
2. Go to the **Screen resolution** control panel (see page 1 - 38) in the Desktop app.
3. Click the **Detect** button.
4. The computer will then detect any attached displays.

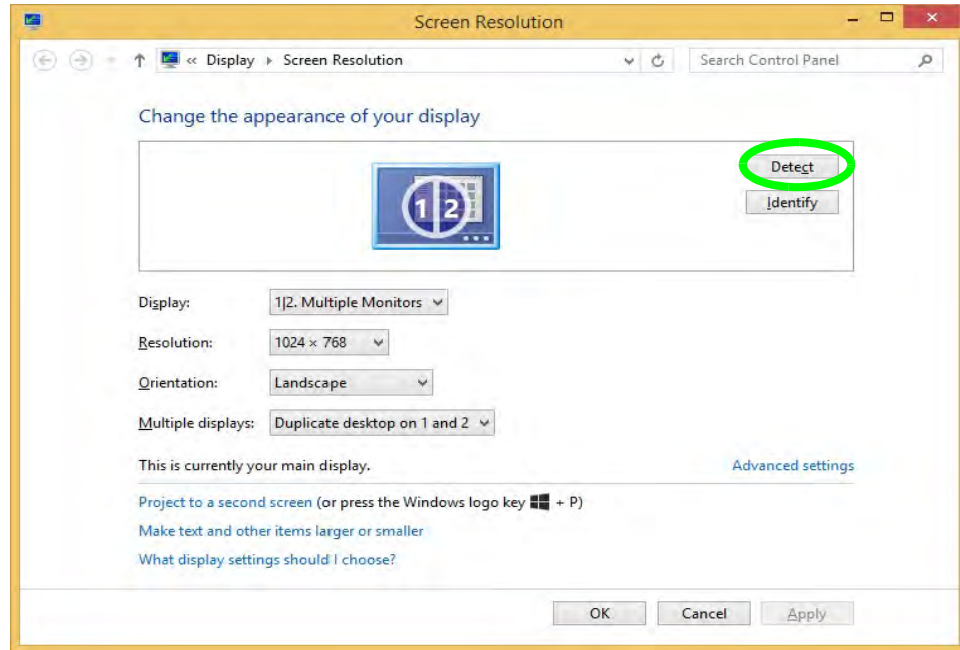

Figure C - 18
Screen Resolution
Multiple Displays

5. You can configure the displays from the **Multiple Displays** menu.

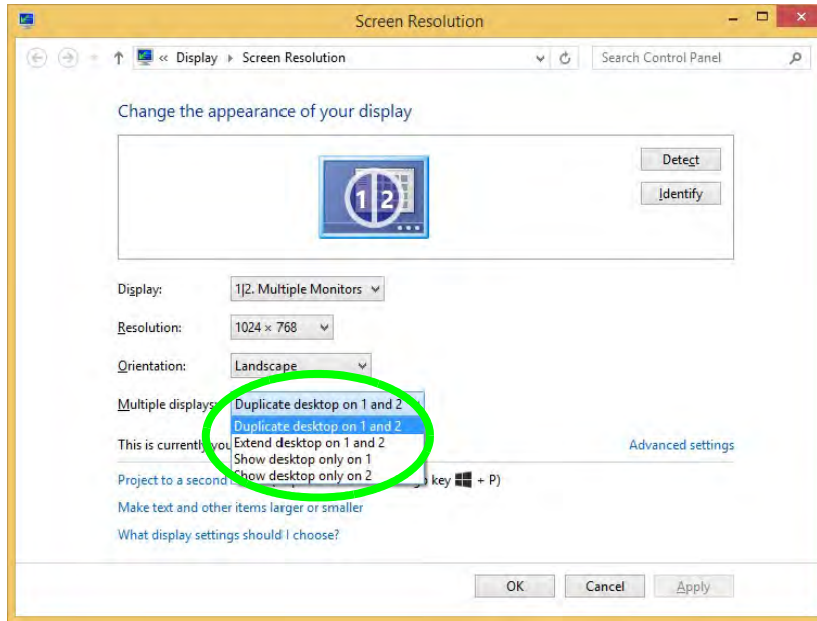

Figure C - 19
Screen Resolution
Multiple Display
Options

- Duplicate these displays - Shows an exact copy of the main display desktop on the other display(s)
- Extend these displays - Treats both connected displays as **separate** devices
- Show desktop only on 1/2 - Only one of your displays is used.



Volume Adjustment

The sound volume level can be set using the volume control in the **Settings** menu in the **Charms Bar**.

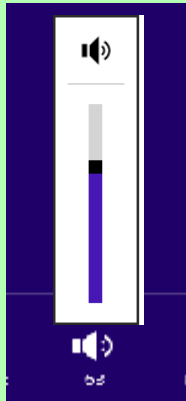



Figure C - 20

**Sound - HDMI
Device (set Default)**

HDMI Audio Configuration

HDMI (High-Definition Multimedia Interface) carries both **audio** and video signals. In some cases it will be necessary to go to the **Sound** control panel and manually configure the HDMI audio output as per the instructions below.

1. Go to the **Control Panel**.
2. Click **Sound**  (**Hardware and Sound**) and click **Playback** (tab)
3. Depending on your display, the playback device may be selected, however in some cases you may need to select the audio device and click **Set Default** (button).
4. Double-click the device to access the control panel tabs illustrated overleaf.

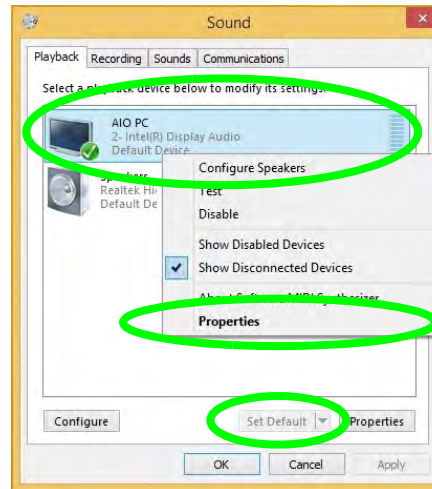

- Adjust the HDMI settings from the control panel tabs.
- Click **OK** to close the **Sound** control panel.

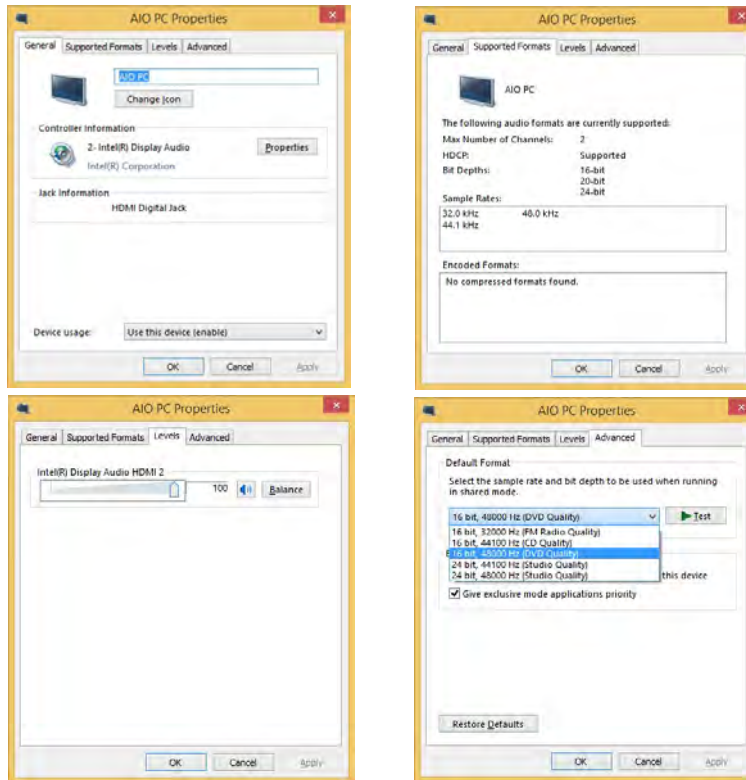

Figure C - 21
HDMI Device
Properties





Other Applications

If you are using a third party application to play DVDs etc. from any attached DVD device, you will need to consult the application's documentation to see the appropriate audio configuration (the application must support digital to analog translation).

HDMI Notes

- Connect a device with HDMI support to the HDMI-Out port **BEFORE** attempting to play audio/video sources through the device.
- To play audio sources through your external display's (TV or LCD) speakers you will need to go to the audio configuration control panel on the display and configure the audio input accordingly (see your display device manual).

HDMI Video Configuration

1. Connect an HDMI cable from the HDMI-Out port to your external display.
2. Configure your external display as per the instructions in *“Attaching Other Displays” on page C - 17.*
3. Set up your external display (TV or LCD) for HDMI input (see your display device manual).
4. You can now play video/audio sources through your external display.

Appendix D: Specifications



Latest Specification Information

The specifications listed in this Appendix are correct at the time of going to press. Certain items (particularly processor types/speeds and CD/DVD device types) may be changed, updated or delayed due to the manufacturer's release schedule. Check with your distributor/supplier for details.

Specifications

Processors	Memory	<u>For Model C Only:</u>
Intel® Pentium® N3700 (1.6GHz) 2MB Smart Cache, 14nm (14 Nanometer), DDR3L-1600MHz, TDP 6W	Dual Channel DDR3L Two 204 Pin SO-DIMM Sockets Supporting DDR3L 1600 MHz Memory Modules (<i>real operational frequency depends on the FSB of the processor</i>)	One Changeable 2.5" / 7.0 mm / 9.5mm (h) HDD / SSD with SATA (Serial) Interface
Intel® Celeron® N3150 (1.6GHz) 2MB Smart Cache, 14nm (14 Nanometer), DDR3L-1600MHz, TDP 6W	Memory Expandable up to 8GB Compatible with 2GB, 4GB or 8GB Modules	<u>For Model A Only:</u> Dummy Optical Device Drive (Factory Option)
Intel® Celeron® N3050 (1.6GHz) 2MB Smart Cache, 14nm (14 Nanometer), DDR3L-1600MHz, TDP 6W	Video Adapter	<u>For Models B & C Only:</u> Dummy Optical Device Drive (Factory Option) or Caddy Bay for 9.5mm (h) ODD or for 2.5" / 7.0mm (h) HDD / SSD (Factory Option)
Intel® Celeron® N3000 (1.04GHz) 2MB Smart Cache, 14nm (14 Nanometer), DDR3L-1600MHz, TDP 4W	Intel® HD Graphics Dynamic Frequency Intel Dynamic Video Memory Technology Microsoft DirectX®11.1 Compatible	Audio
Display	Storage	High Definition Audio Interface Built-In Microphone 2 * Built-In Speakers Built-In Array Microphone (Factory Option)
<u>For Model A:</u> 14.0" / 35.56cm HD (1366 * 768), 16:9 3.6mm Thick Backlit Panel <u>For Model B:</u> 15.6" / 39.62cm HD (1366 * 768), 16:9 3.8mm Thick Backlit Panel <u>For Model C:</u> 17.3" / 43.94cm HD+ (1600 * 900), 16:9 6.0mm Thick Backlit Panel	<u>For All Models:</u> One Changeable 9.5mm(h) Super Multi Optical Device Drive with SATA Interface (Factory Option) <u>For Models A & B:</u> One Changeable 2.5" / 7.0 mm (h) HDD/ SSD with SATA (Serial) Interface	<u>Pointing Device & Keyboard</u> Built-in TouchPad or ClickPad with Multi- Gesture and Scrolling Functionality <u>For Model A:</u> A4 Size Isolated Keyboard <u>For Models B & C:</u> Full Size Isolated Winkey Keyboard with Numeric Keypad

<p>Interface</p>	<p>Slot</p>	<p>Intel® Dual Band Wireless-AC 3165 (1*1 802.11 a/c) WLAN + Bluetooth M.2 2230 Combo Module (Factory Option)</p> <p>3rd Party WLAN (802.11b/g/n) + Bluetooth v4.0+LE M.2 2230 Combo Module (Factory Option)</p> <p>For Models A & B Only: 3G UTMS/HSPA+ M.2 3042 Card Module (Factory Option) OR 4G LTE M.2 3042 Card Module (Factory Option)</p>
<p>For Model A: One USB 2.0 Port</p> <p>For Models B & C: Two USB 2.0 Ports</p> <p>=====</p> <p>Two USB 3.0 Ports One External Monitor Port One HDMI-Out (High-Definition Multimedia Interface) Port (with HDCP) One Headphone-Out Jack One Microphone-In Jack One RJ-45 LAN Jack One DC-In Jack</p>	<p>For Models A & B: Two M.2 Card Slots:</p> <p>Slot 1 for WLAN M.2 Combo Module with PCIe & USB Interfaces Slot 2 for LTE or UTMS/HSPA (3G/4G) M.2 Module with USB interface (Factory Option)</p> <p>=====</p> <p>For Model C: One M.2 Slot:</p> <p>Slot 1 for WLAN M.2 Combo Module with PCIe & USB Interfaces</p>	<p>Power Management</p>
<p>Card Reader</p>	<p>Communication</p>	<p>Supports Wake on LAN Supports Wake on USB Supports Wake on RTC Alarm (AC Mode Only)</p>
<p>Embedded Multi-In-1 Card Reader (Push-Push Card Reader for Model C)</p> <p>For All Models:</p> <ul style="list-style-type: none"> - MMC/ RS MMC - SD/ Mini SD / SDHC/ SDXC <p>For Models A & B Only:</p> <ul style="list-style-type: none"> - MS/ MS Pro/ MS Duo <p>Note: Some cards require PC adapters that are usually supplied with the cards.</p>	<p>Built-In 10/100/1000Mb Base-TX Ethernet LAN</p> <p>1.0M HD Video Camera Module with USB interface (Factory Option)</p> <p>Intel® Wireless-N 7265 (2*2 802.11 b/g/n) WLAN + Bluetooth M.2 2230 Combo Module (Factory Option)</p>	<p>Power & Battery</p> <p>For All Models: Full Range AC/DC Adapter AC input 100 - 240V, 50 - 60Hz, DC Output 19V, 2.1A (40 Watts)</p>



Specifications

<p><u>For Model A:</u> Embedded 4 Cell Smart Lithium Ion Battery Pack 32WH OR Embedded 4 Cell Smart Lithium Ion Battery Pack 44WH (Factory Option) OR Embedded 6 Cell Smart Lithium Ion Battery Pack 48WH (Factory Option) OR Embedded 3 Cell Smart Lithium Ion Battery Pack 24WH (Factory Option)</p>	<p>Features</p> <p>Painted Style (For some Model A & B Designs) IMR (Injected Molded Resin) LCD Back Covers (For some Model A & C Designs) Shipping Mode FlexiCharger</p>	<p>Relative Humidity Operating: 20% - 80% Non-Operating: 10% - 90%</p>
<p><u>For Models B & C:</u> Removable 4 Cell Smart Lithium-Ion Battery Pack 32WH OR Removable 4 Cell Smart Lithium-Ion Battery Pack 44WH (Factory Option)</p>	<p>Operating System</p>	<p>Dimensions & Weight</p>
<p>Security</p>	<p>Windows® 8.1 (64-bit) Windows® 10 (64-bit)</p>	<p><u>Model A:</u> 340mm(w) * 242mm(d) * 26.5mm(h) <i>(Height excluding battery area)</i> 2.0 kg *Barebone System with 32WH Battery & ODD</p>
<p>Security (Kensington® Type) Lock Slot BIOS Password Trusted Platform Module 2.0 (Factory Option) Intel® PTT</p>	<p>Indicators</p>	<p><u>Model B:</u> 374mm (w) * 258.5mm (d) * 12 - 24.7mm (h) 2.1kg *Barebone System with 32WH Battery and ODD</p>
	<p>LED Indicators - Power/Suspend, Battery, HDD/ODD, Airplane Mode, Camera</p>	<p><u>Model C:</u> 413mm (w) * 273mm (d) * 12.7 - 28.5mm (h) 2.5kg *Barebone System with 32WH Battery and ODD</p>
	<p>BIOS</p>	
	<p>One 64Mb SPI Flash ROM AMI BIOS</p>	
	<p>Environmental Spec</p>	
	<p>Temperature Operating: 5°C - 35°C Non-Operating: -20°C - 60°C</p>	<p><i>*A barebone system does not include the HDD, RAM, adapter, power cord and factory option modules (weight tolerance within +/- 5%).</i></p>

Appendix E: Windows 10

Overview

This Appendix contains information (including control panel information, driver installation etc.) for users of the *Windows 10 OS*.



You can refer to the main manual for details of audio & video information, BIOS, modules etc. However drivers information specific to *Windows 10* will be included in this Appendix, as well as details on how to navigate the *Windows 10* user interface to access the applications, control panels, taskbar etc. Note that *Windows 10* will be subject to constant updates and revisions, and some of the screens pictured throughout this chapter may change over the course of time and appear differently from those illustrated.



Windows 10 OS

In order to run *Windows 10 64 bit*) your computer requires a minimum **2GB** of system memory (RAM).

Windows 10 Start Menu

Most of the apps, control panels, utilities and programs within *Windows 10* can be accessed from the **Start Menu** by clicking the icon  in the taskbar in the lower left corner of the screen (or by pressing the **Windows Logo Key**  on the keyboard).

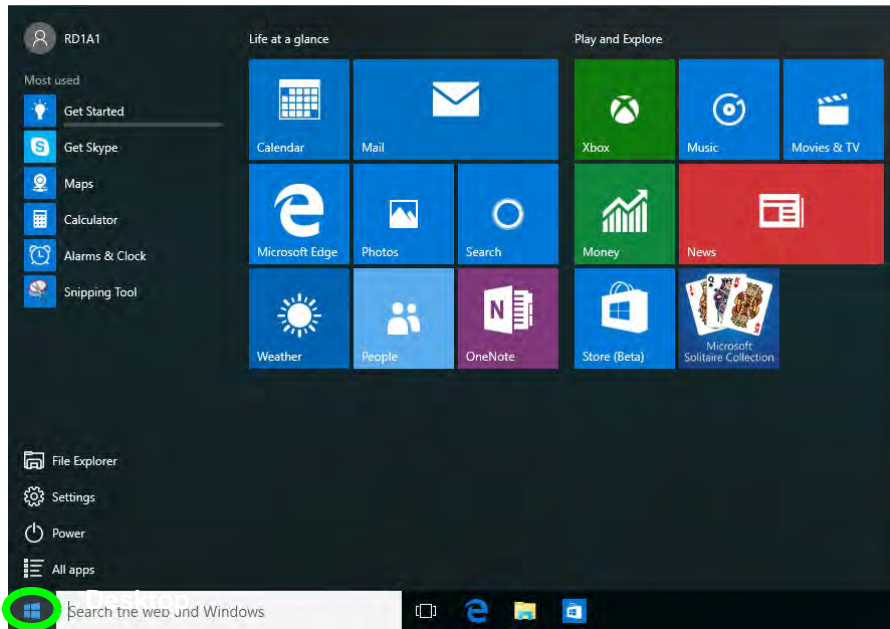

Figure E - 1 - Windows Start Menu

Right-Clicking the Windows Logo In Start Menu

Right-click the Start Menu  icon (or use the **Windows Logo Key**  + **X** key combination) to bring up an advanced **Context Menu** of useful features such as Control Panel, Programs and Features, Power Options, Task Manager, Search, File Explorer, Command Prompt, Device Manager and Network Connections etc.

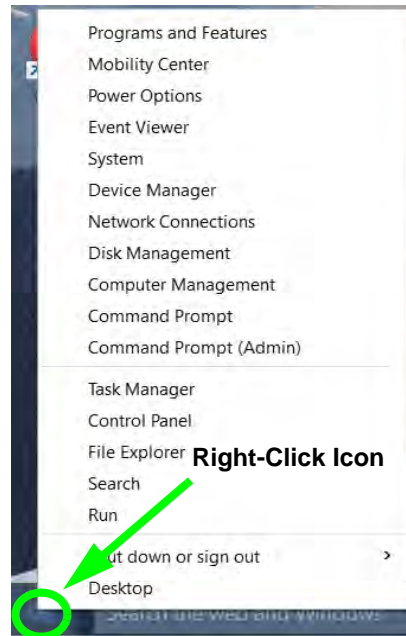

Figure E - 2 - Right-Click Windows Logo in Start Menu

Windows 10

Start Menu Apps & Tiles

The **Windows 10** Start Menu will contain a number of apps, and many more will be installed as you add more applications etc. Not all of these apps can fit on the screen so may need click and drag the handles at the edge of the screen to expand the menu in order to view all the apps (you can use the scroll bar to move up and down the screen).

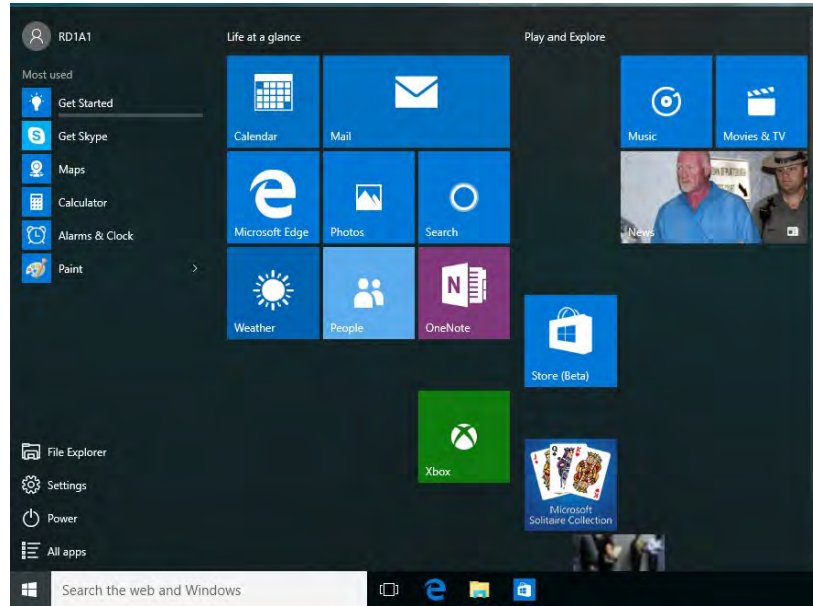

Figure E - 3 - Expanding the Start Menu

E - 4 Windows 10 Start Menu

Pining/Unpinning Apps & Programs to/from the Start Menu

To make things easy to find you can add and remove tiles for apps and programs to the Start Menu. Right-Click on a program's icon and select **Pin to Start** from the drop-down menu. To remove an app or program from the Start Menu right-click the icon and select **Unpin from Start**. You can use the same method to **pin apps/programs to/from the taskbar** (select pin to taskbar/unpin this program from the taskbar).

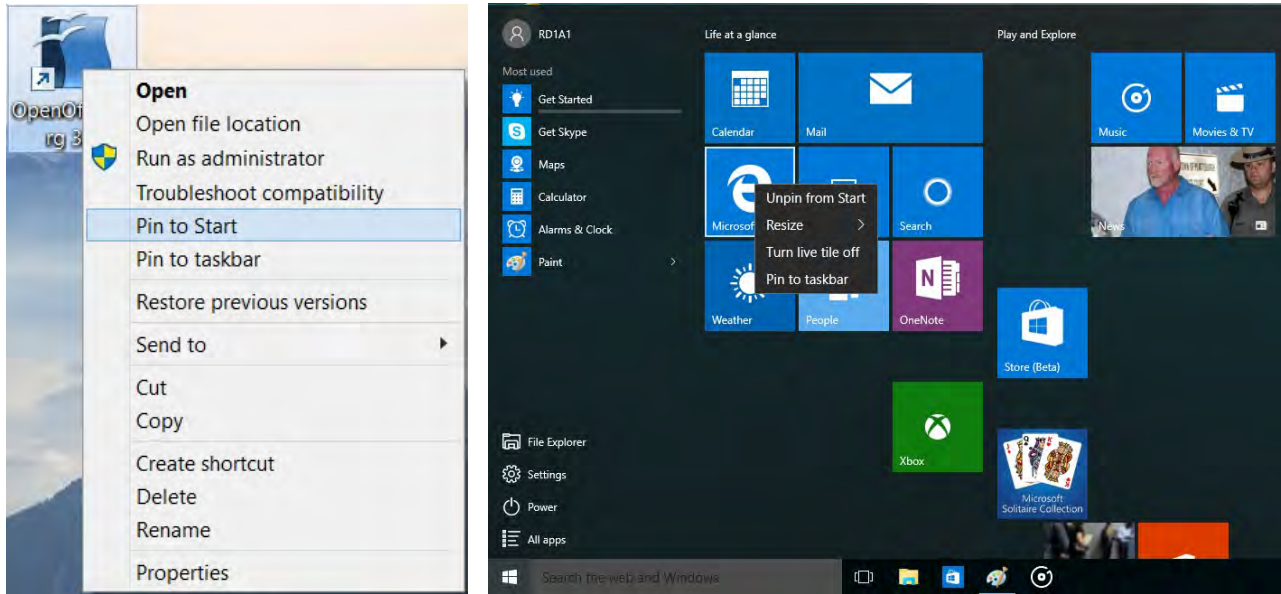



Figure E - 4 - Pin to Start/Unpin from Start

Windows 10 Control Panel

In many instances throughout this manual you will see an instruction to open the **Control Panel**. The Control Panel can be accessed in a number of ways in *Windows 10*.

- Right-click the Start Menu icon  in the taskbar in the lower left corner of the screen and select Control Panel from the menu.
- Press the Windows logo key  on your keyboard and **X** to bring up the context menu, and then press **P** to bring up the Control Panel.
- Type *Control Panel* into the Search box in the taskbar and click on the icon when it pops up.

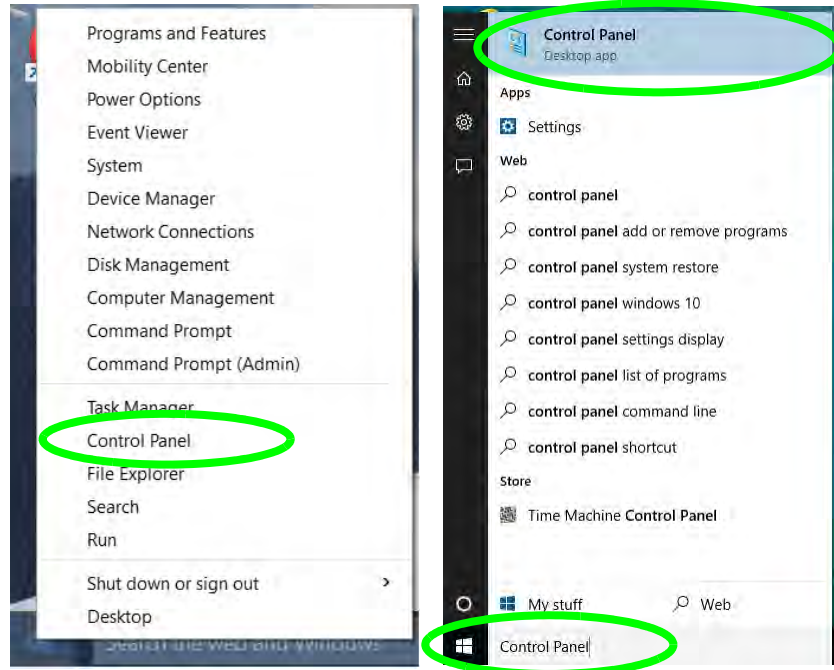

Figure E - 5 - Windows 10 Control Panel Access

Settings

The **Settings** item in the Start Menu (and also as an App) gives you quick access to a number of system settings control panels allowing you to adjust settings for System, Devices, Network & internet, Personalization, Accounts, Time & language, Ease of Access, Privacy and Update & security.

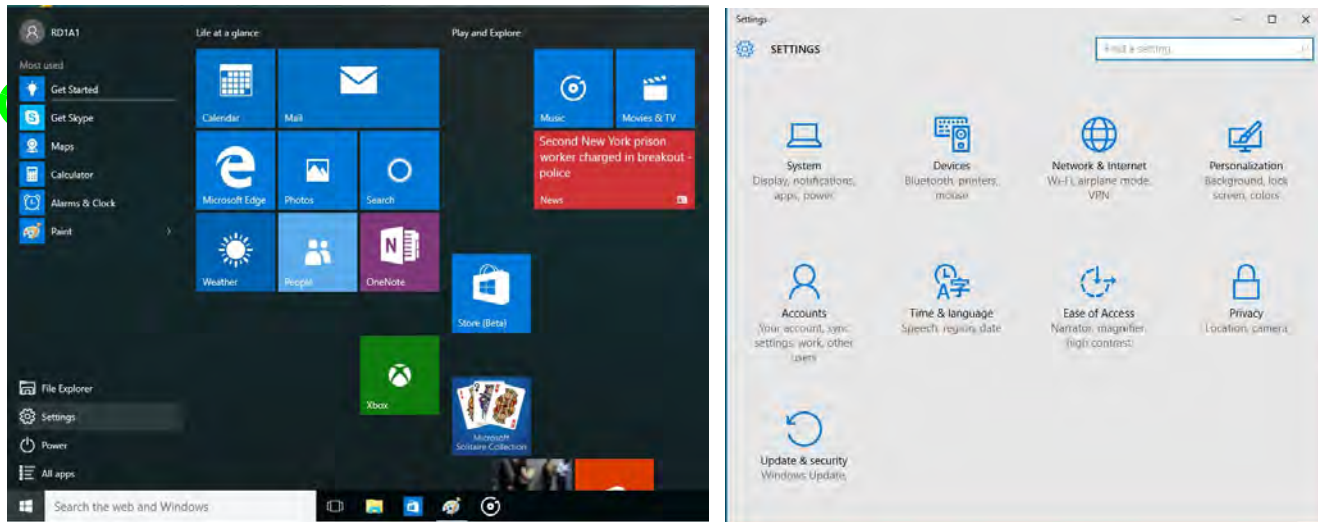

Figure E - 6 - Settings

Windows 10

Windows 10 Taskbar

In many instances throughout this manual you will see an instruction to access the **notification area of the taskbar**. The notification area of the taskbar in the bottom right of the screen. Some of the Control Panels and applications referred to throughout the course of this manual can be accessed from here.



Taskbar

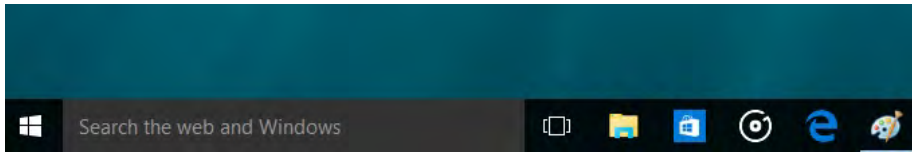

Taskbar - Pinned Programs and Apps



Notification Area

Figure E - 7 - Taskbar

You can pin/unpin apps to/from the taskbar in much the same way as you can to the Start screen (see *[“Pining/Unpinning Apps & Programs to/from the Start Menu”](#)* on page E - 5).

E - 8 Windows 10 Control Panel

Video Features

You can switch display devices, and configure display options, from the **Display** control panel (in **Appearance and Personalization**). Click **Adjust resolution** to make changes to the appearance of the display and to detect and configure any attached displays. In *Windows 10* it is possible to quickly configure external displays from the **Media Connect** menu (press the Windows logo key  on your keyboard and the **P** key).

To Configure Displays using Project

1. Attach your display to the appropriate port, and turn it on.
2. Press the  + **P** key combination.
3. Click on any one of the options from the menu to select **PC screen only**, **Duplicate**, **Extend** or **Second screen only**.
4. You can also click **Connect to a wireless display** at the bottom of the **Project** screen and follow the steps to connect to any wireless enabled display.

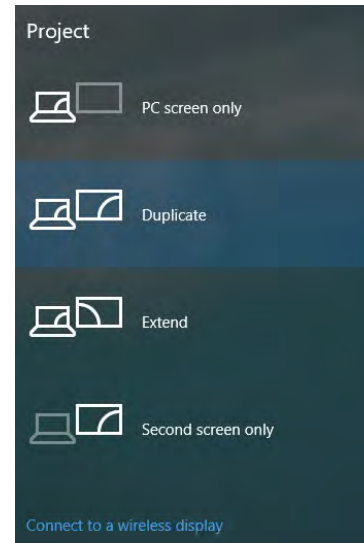
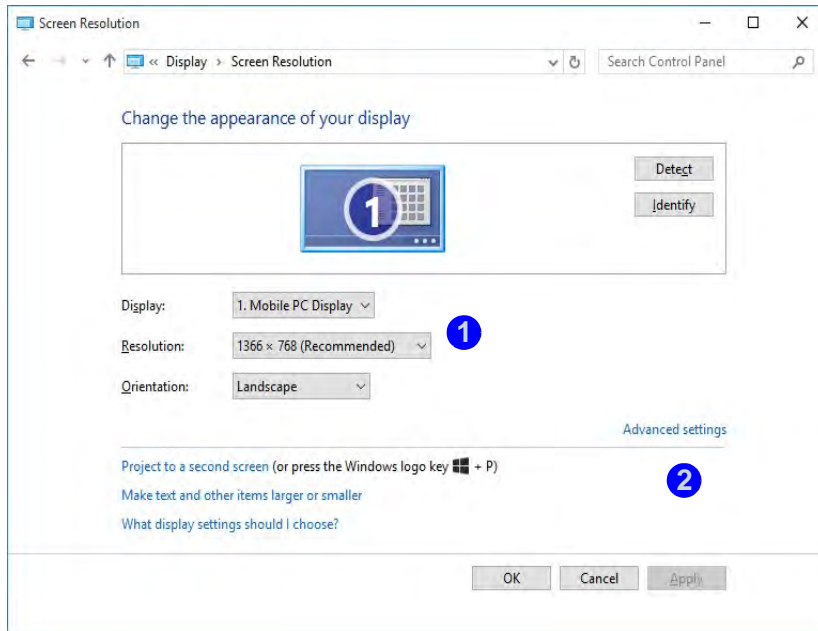

Figure E - 8 - Project (Devices)

Windows 10

To access **Display (Control Panel)** and **Screen Resolution** in *Windows*:

1. Go to the **Control Panel**.
2. Click **Display** (icon) - In the **Appearance and Personalization** category.
3. Make and changes required from the **Display, Resolution, Orientation** or **Multiple display** menus.
4. Click **Apply** to save the settings.



Screen Resolution

1. Use the dropdown to select the screen **Resolution** **1** (*Figure E - 9*).
2. Click **Advanced settings** **2** (*Figure E - 9*) to bring up the **Advanced** properties tabs.
3. Click **Apply** to save any changes made.

Figure E - 9 - Screen Resolution

Display Settings:

1. You can quickly adjust the display by right-clicking the desktop and selecting **Display Settings** ①.
2. Adjust the settings using the sliders in the menu or click **Advanced display settings** ② to change resolution.
3. Click **Apply** to save any changes made to resolution.

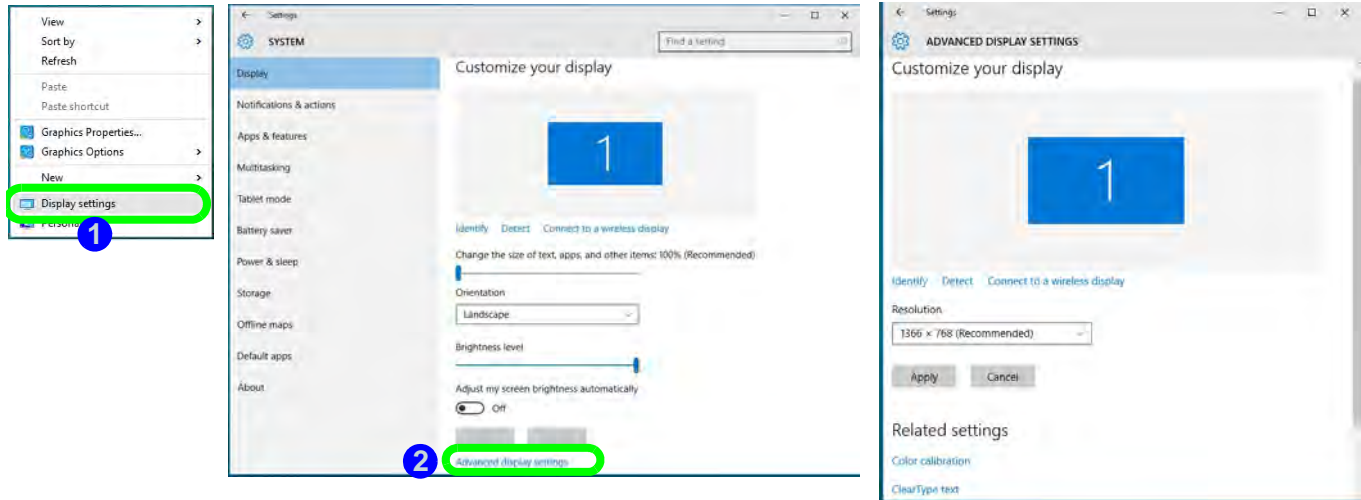



Figure E - 10 - Display Settings

Power Options

Power Options (Hardware and Sound) can be accessed from the Control Panel. The **Power** button item in **Start Menu** (or the context menu) may be used to **Shut down** or **Restart** (you can also add **Hibernate/Sleep** to the menu - see page [E - 13](#)). To fully control all the power options (including Hibernate mode) go to the **Power Options** control panel and configure the power button, sleep button and lid to perform the function selected.

Using the Power Button

1. Go to the **Start Menu**.
2. Click the **Power button** .
3. Select the power state required from the menu.

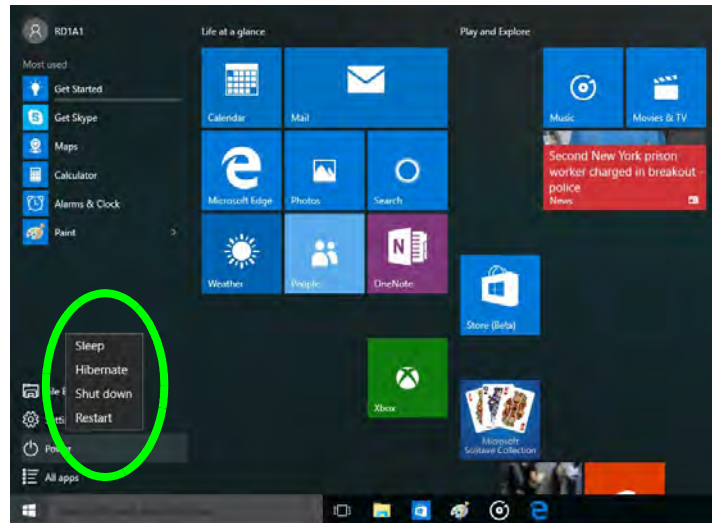



Figure E - 11 - Shut Down/Restart

You can also use the **context menu** (right-click the Start Menu  icon or press the Windows logo  + **X** key combination) to **Sign out, Sleep, Hibernate, Shut down, and Restart**.

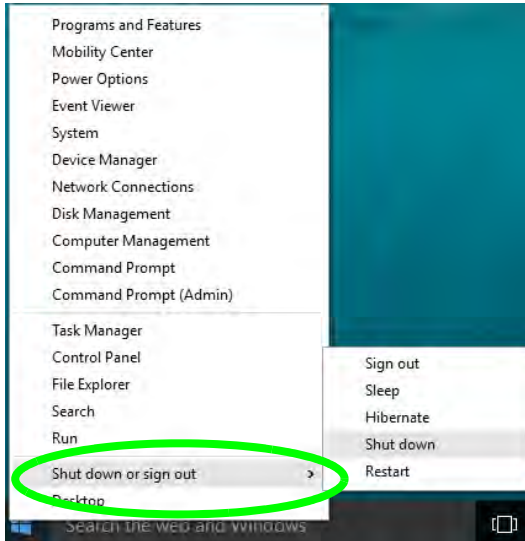



Figure E - 12 - Context Menu Shut Down or sign out

Adding Hibernate/Sleep to the Power Men

1. Go to the **Power Options (Hardware and Sound)** control panel.
2. Click **Choose what the power buttons do**.
3. Click "**Change settings that are currently unavailable**"  [Change settings that are currently unavailable](#).
4. Click to put a check in the **Hibernate/Sleep** box under **Shutdown settings**.
5. Click **Save Changes** and close the control panel.

Ctrl + Alt + Delete Key Combination

You can use the **CTRL + ALT + DEL** key combination to bring up a full-screen displaying **Lock, Sign out, Change a password, Task Manager and Switch User**. If you click the **Power** icon in the lower right corner of the screen a power management option menu appears to display **Sleep, Hibernate, Shut down, and Restart**.

Windows 10

Minimum Screen Resolution Settings

1. **Windows 10** has minimum screen resolution requirements.
2. Right-click a blank area of the Desktop and select **Screen Resolution** (or go to the **Display** control panel).
3. Adjust the **Resolution** to make sure that it is at least **1024 * 768**, although preferably **1366 * 768** or above.

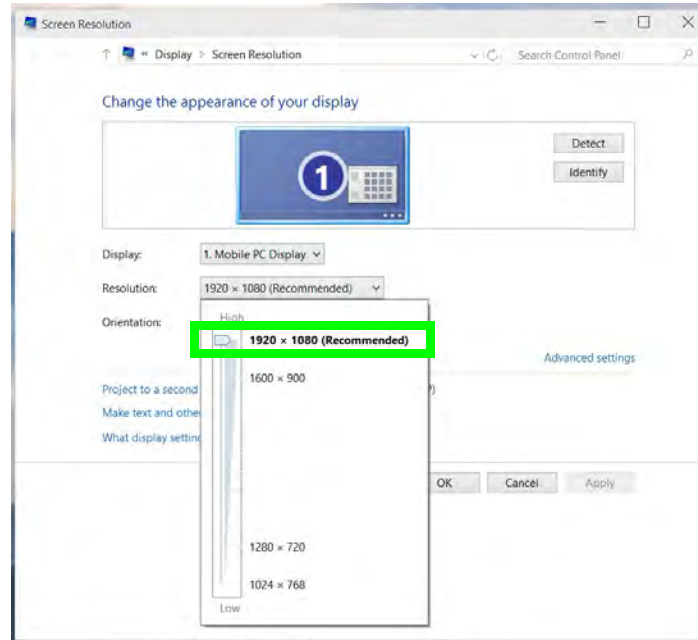

Figure E - 13 - Screen Resolution

Windows 10 Drivers & Utilities

Make sure you install all the drivers and utilities for your *Windows 10* system as outlined in the following pages.

Driver Installation (Windows 10)

1. Insert the *Device Drivers & Utilities + User's Manual* disc into the computer's DVD drive, or an attached DVD drive if applicable.
2. Click the message "**Tap to choose what happens with this disc.**"
3. Click **Run autorun.exe**.
4. Click **Install Drivers** (button), or **Option Drivers** (button) to access the **Optional** driver menu.
5. Check the driver installation order from **Table E - 1, on page E - 16 (the drivers must be installed in this order)** which is the same as that listed in the **Drivers Installer** menu below.
6. Click to select the driver you wish to install, (you should note down the drivers as you install them).
7. Follow the instructions for each individual driver installation procedure as listed on the appropriate pages.



Driver Installation

If you miss the message above you can eject the *Device Drivers & Utilities + User's Manual* disc and then reinsert it.

Alternatively **double-click the disc icon in Computer** (use the **Windows logo key**  + **E** key combination to go to **Computer** in Windows Explorer).

Windows 10

Windows 10 (64-bit) Drivers			
<i>Chipset</i>	<i>Page E - 17</i>	<i>Wireless LAN Module</i>	<i>Page E - 20</i>
<i>Video (VGA)</i>	<i>Page E - 17</i>	<i>Bluetooth & WLAN Combo Module</i>	<i>Page E - 22</i>
<i>LAN</i>	<i>Page E - 17</i>	<i>PC Camera</i> (No driver required)	<i>Page E - 25</i>
<i>Card Reader</i>	<i>Page E - 17</i>	<i>3G/4G Module</i> (No driver required)	<i>Page E - 26</i>
<i>Touchpad</i>	<i>Page E - 17</i>	<i>Trusted Platform Module</i> (No driver required)	<i>Page E - 28</i>
<i>Airplane</i>	<i>Page E - 18</i>		
<i>Intel TXE</i>	<i>Page E - 18</i>		
<i>Control Center</i>	<i>Page E - 18</i>		
<i>Intel® DPTF Driver Installation</i>	<i>Page E - 18</i>		
<i>Audio</i>	<i>Page E - 18</i>		

Table E - 1 - Driver Installation

Driver Installation Procedure

Insert the *Device Drivers & Utilities + User's Manual disc* and click **Install Drivers** (button).

Chipset

1. Click **1.Install Chipset Driver > Yes**.
2. Click **Next > Accept > Install**.
3. Click **Restart Now** to restart the computer.

Video (VGA)

1. Click **2.Install VGA Driver > Yes**.
2. Click **Next > Yes > Next > Next**.
3. Click **Finish** to restart the computer.

LAN

*Note: If the computer enters a deep sleep mode during installation, you will be prompted to plug in a network cable, and click **OK**, to continue installation. If a network cable is not available, restart the system and re-install the LAN driver.*

1. Click **3.Install LAN Driver > Yes**.
2. Click **Next > Install**.
3. Click **Finish**.

Card Reader

1. Click **4.Install Cardreader Driver > Yes**.
2. Click **Finish**.

Touchpad

1. Click **5.Install Touchpad Driver > Yes**.
2. Click **Next**.
3. Click the button to accept the license, and then click **Next**.
4. Click **Finish > Restart Now** to restart the computer.

Airplane

Note: Do not use Update Driver in Device Manager to install the Airplane Mode driver.

1. Click **6.Install Airplane Driver > Yes**.
2. Click **Next > Install**.
3. Click **Finish** to restart the computer.

Intel TXE

1. Click **7.Install TXE Driver > Yes**.
2. Click **Next**.
3. Click the check box to accept the license agreement and click **Next**.
4. Click **Next > Finish**.

Control Center

1. Click **8.Install Control Center AP > Yes**.
2. Click **Next > Install**.
3. Click **Finish** to restart the computer.

Intel® DPTF Driver Installation

1. Click **9.Install DPTF Driver > Yes**.
2. Click **Next**.
3. Click **Yes** to accept the license.
4. Click **Next > Finish**.
5. See *“Intel® Dynamic Platform & Thermal Framework” on page 3 - 22* for details.

Audio

1. Click **10.Install Audio Driver > Yes**.
2. Click **Next**.
3. Click **Finish** to restart the computer.

Note that after installing the audio driver the system will not return to the *Drivers Installer* screen. To install any of the optional drivers listed overleaf, eject the *Device Drivers & Utilities + User's Manual* disc and then reinsert it (or double-click the disc icon in **My Computer**), and click *Option Drivers* (button) to access the optional driver menu.

Optional Drivers

See the following pages for the driver installation procedures for any modules included in your purchase option.

Note that you need to install both the WLAN & Bluetooth drivers for the WLAN & Bluetooth Combo modules.

Wireless LAN Module

If you have included an **Intel®** or **3rd Party WLAN** module in your purchase option make sure that the module is on (i.e. the system is not in **Airplane Mode**) before installing the driver. Make sure you install the drivers in the order indicated in *Table E - 1, on page E - 16*.

Note that you need to install both the WLAN & Bluetooth drivers for the WLAN & Bluetooth Combo modules.



Wireless Device Operation Aboard Aircraft

The use of any portable electronic transmission devices aboard aircraft is usually prohibited.

Make sure the module is either **OFF** or in **Airplane mode** if you are using the computer aboard aircraft.

3rd Party WLAN Driver Installation

1. **Make sure the system is not in Airplane Mode**, and then insert the *Device Drivers & Utilities + User's Manual* disc into the DVD drive.
2. Click **Option Drivers** (button).
3. Click **1.Install WLAN Driver > Yes**.
4. Click **Next**.
5. Click **Finish** to restart the computer.
6. The operating system is the default setting for Wireless LAN control in *Windows 10*.
7. Click the Wireless icon  in the notification area of the taskbar and double-click an access point to connect to it (or click it and click **Connect**).

Intel® WLAN Driver Installation

1. **Make sure the system is not in Airplane Mode**, and then insert the *Device Drivers & Utilities + User's Manual* disc into the DVD drive.
2. Click **Option Drivers** (button).
3. Click **1.Install WLAN Driver > Yes**.
4. Click in the check box to agree to the **End User License Agreement** and click **Install**.
5. Click **Finish** (click **Yes** if required to restart).
6. The operating system is the default setting for Wireless LAN control in *Windows 10*.
7. Click the Wireless icon  in the notification area of the taskbar and double-click an access point to connect to it (or click it and click **Connect**).

Bluetooth & WLAN Combo Module

If your purchase option includes the **Combination Wireless LAN & Bluetooth module** (either **Intel®** or **3rd Party**) then install the driver as instructed overleaf (two drivers are provided for the 3rd party WLAN module and one for the Intel WLAN module). Make sure you install the drivers in the order indicated in *Table E - 1, on page E - 16*.

Make sure that the module is on (i.e. the system is not in **Airplane Mode**) before installing the driver.



Bluetooth Data Transfer

Note that the transfer of data between the computer and a Bluetooth enabled device is supported in one direction only (simultaneous data transfer is not supported). Therefore if you are copying a file from your computer to a Bluetooth enabled device, you will not be able to copy a file from the Bluetooth enabled device to your computer until the file transfer process from the computer has been completed.



Wireless Device Operation Aboard Aircraft

The use of any portable electronic transmission devices aboard aircraft is usually prohibited. Make sure the module is either **OFF** or in **Airplane mode** if you are using the computer aboard aircraft.

3rd Party Bluetooth Combo Driver Installation

1. **Make sure the system is not in Airplane Mode**, and then insert the *Device Drivers & Utilities + User's Manual* disc into the DVD drive.
2. Click **Option Drivers** (button).
3. Click **2.Install Combo BT Driver > Yes**.
4. Click **Next**.
5. Click **Finish** to restart the computer.
6. See *“Bluetooth Configuration” on page E - 24* for instructions on configuring Bluetooth connections.

Intel Bluetooth Combo Driver Installation

1. **Make sure the system is not in Airplane Mode**, and then insert the *Device Drivers & Utilities + User's Manual* disc into the DVD drive.
2. Click **Option Drivers** (button).
3. Click **2.Install Combo BT Driver > Yes**.
4. Click **Next > Next**.
5. Click in the check box to accept the license and click **Next**.
6. Select the setup type (**Typical** is recommended) and click **Install**.
7. Click **Finish**.
8. See *“Bluetooth Configuration” on page E - 24* for instructions on configuring Bluetooth connections.





Bluetooth Configuration

1. Click the **Settings** item in the Start Menu and then click **Devices**.
2. Click **Bluetooth** and make sure Bluetooth is **On** and a list of discovered devices will appear.
3. Double-click the device you want to pair with the computer and click **Pair**.
4. On first connection the computer will provide you with a pairing code to be entered onto the device.
5. Enter the code into your Bluetooth enabled device and click **Yes** on the computer to complete the pairing.
6. Select a device and click **Remove Device** to disconnect from any device.
7. Click **More Bluetooth Options**, and make sure that **Allow Bluetooth devices to find this computer** check box (**Discovery**) has a check inside it.
8. Make sure that the **Alert me when a new Bluetooth device wants to connect** check box (**Connections**) has a check inside it, if you want to be notified when a Bluetooth device wants to connect.

PC Camera

Use the **Fn + F10** key combination or **Control Center button** to toggle power to the PC Camera module. When the PC Camera is in use the LED indicator to the left of the camera will be illuminated.

Note that you need to use the **Camera app**  in *Windows* to take pictures and capture video.

1. Make sure the PC Camera is turned on by using the **Fn + F10** key combination (or **Control Center button**).
2. Run the Camera app from the Start menu by clicking on the **Camera app** icon  (you can type “camera” into the search box to find the Camera app if it is not pinned to the Start menu).
3. Click to select either **photo**  or **video**  modes.
4. Click the photo icon to take a picture, and the camera icon will briefly turn yellow as the picture is taken.
5. Click on the video icon  to start video capture (if video capture begins a timer will appear at the bottom of the screen and the icon will turn yellow).
6. To stop video capture click the video icon again.
7. Captured photos and videos will be saved to a **Camera Roll** folder within the **Pictures/Videos** folder in **This PC**, and to the **Photos** app stored in the Start menu (type **Photos** into the search box if you cannot find the app).

3G/4G Module

If you have included an **optional UMTS/HSPA+** based 3G Module (Universal Mobile Telecommunications System or High Speed Packet Access) module or **LTE** (Long Term Evolution) 4G module (see “*Communication*” on page D - 3 for specification details) in your purchase option, **you do not require a driver/application installation for Windows 10**. See “*3G/4G Module USIM Card Installation for Model B Computers*” on page 6 - 22/“*3G/4G Module USIM Card Installation for Model A Computers*” on page 6 - 23 for instructions on installing the USIM card (which will be provided by your service provider). See overleaf for connection information.



Important Notice

If your purchase option includes both Wireless LAN and 3G/4G modules, then the appropriate antennas will be installed. Note that in order to comply with FCC RF exposure compliance requirements, the antenna must not be co-located or operate in conjunction with any other antenna or transmitter.

Important Notice - 3G/4G & Bluetooth/Wireless LAN Modules

In order to comply with FCC regulations you should NOT operate the 3G/4G module and the Bluetooth/Wireless LAN modules at the same time as this may disrupt radio frequency, and cause interference. When the 3G/4G module is powered on, make sure that the Bluetooth/Wireless LAN modules are powered off.

3G/4G Configuration in Windows 10

You can configure a 3G/4G connection as below, however make sure the system is not in Airplane Mode before configuration begins.

1. Click the **Settings** item in the Start Menu and then click **Network and Internet**.
2. Click **Cellular** a list of available access points will appear.
3. Click the access point and click **Connect**.
4. The system will connect to your network.
5. **Connected** will appear under the connection.
6. You can then access the internet, download e-mail etc. as per any internet connection.
7. To disconnect you can select the connection and click **Disconnect**.
8. You need to use **Airplane Mode** aboard aircraft.
9. You can also click the Wireless icon  in the notification area of the taskbar, click **Cellular** and double-click an access point connect to access the connection information.

Trusted Platform Module

(Optional)

The **TPM security chip** allows you to create and manage digital certificates for user and platform authentication. This type of security is usually administered within large enterprises and organizations, and therefore requires implementation by a system administrator before users can access security features.

Make sure you have administrator's rights to your computer, and have a **Windows** password enabled for full security protection. In addition **Make sure you prepare a removable media (e.g. a USB flash drive) to store passwords etc. before beginning the TPM initialization process.**

Before setting up the TPM functions you must enable and initialize the security platform (see *“Enabling & Activating TPM” on page 6 - 28*).

TPM Management in Windows

1. Go to the **Control Panel**.
2. Click **BitLocker Drive Encryption (System and Security)**.
3. Click **TPM Administration**.
4. The TPM Management window allows you to configure the TPM within **Windows**. As TPM is usually administered within large enterprises and organizations, your system administrator will need to assist you in managing the information here.
5. Click **Prepare the TPM** and follow the instructions in the Wizard to prepare the TPM (this will probably require a restart of the computer and confirmation of the setting changes after restart by pressing the appropriate F key).
6. After the restart the TPM will be prepared and you can then use the **Actions** menu to **Turn TPM off, Change Owner Password, Clear TPM** or **Reset TPM Lockout**.
7. A wizard will help take you through any setup steps.